



Appendix F

Groundwater Impact Assessment



EMM Consulting Pty Ltd
Cowal Underground Development EIS
Mine Site Hydrogeological Assessment

10 September 2020

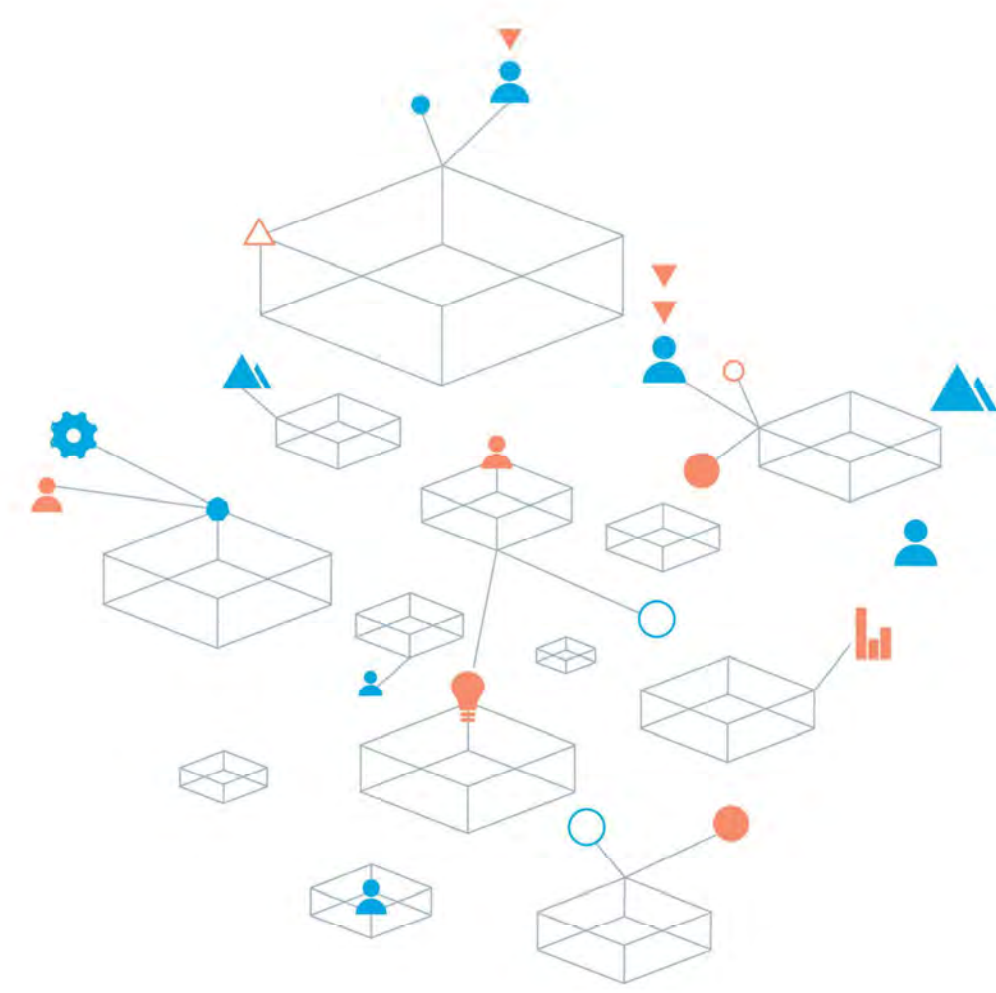

Trust is the
cornerstone
of all our
projects

This page has been left intentionally blank

Cowal Underground Development EIS

Prepared for
EMM Consulting Pty Ltd

Prepared by
Coffey Services Australia Pty Ltd
Level 19, Tower B, Citadel Tower, 799 Pacific Highway
Chatswood
NSW 2067 Australia
t: +61 2 9406 1000 f: +61 2 9415 1678
ABN 55 139 460 521

10 September 2020

Mine Site Hydrogeological Assessment

754-SYDGE206418-3-AM

Quality information

Revision history

Revision	Description	Date	Originator	Reviewer	Approver
Draft 01	Draft	2 July 2020	AO	RJB	RJB
Rev 1	EMM review comments addressed	27 August 2020	AO	RJB	RJB
Final	EMM final review comments addressed	10 September 2020	AO	RJB	RJB

Distribution

Report Status	No. of copies	Format	Distributed to	Date
Draft	1	PDF	Paul Freeman	2 July 2020
Rev 1	1	PDF	Paul Freeman	27 August 2020
Final	1	PDF	Paul Freeman	10 September 2020

Executive summary

Cowal Gold Operations (CGO) is an existing open cut mine site, which has been operational since commencement in 2005, located immediately adjacent to the ephemeral lake, Lake Cowal. Evolution Mining seeks to extend mining operations at the CGO by way of an underground development, which would be wholly contained within Mining Lease (ML) 1535. The Underground Development proposal seeks to introduce an underground mine using stope mining practices, in addition to the existing open cut mine, to exploit an identified ore deposit.

A hydrogeological assessment was undertaken by Coffey Services Australia Pty Ltd (Coffey) to assess potential impacts on the groundwater system under the proposed Cowal Gold Operations (CGO) Underground Development. The assessment employed predictive numerical modelling based on an existing numerical groundwater flow model which was completely re-worked, taking into account the proposed underground mining to the north of the existing open pit.

The numerical groundwater flow model was calibrated using an automated process using the open source software PEST. This resulted in adopted aquifer properties that provided a good fit to observed open pit inflows and to groundwater monitoring data from 22 locations over a fourteen year period from 2005 to 2020 and four locations above the proposed underground development where monitoring commenced in February 2020. Calibration results showed vertical hydraulic conductivities for the lake sediments underlying Lake Cowal to be in the very low range and substantially lower than the horizontal hydraulic conductivities. A similar result was found for the weathered rock units underlying the lake sediments.

Modelling results indicate that groundwater table drawdown is expected to lie completely within the CGO mining leases ML1535 and ML1791 over the life of the mine. Combined groundwater inflows into the proposed stopes and access tunnels are predicted to range from approximately 100 m³/day in 2022 to 2,300 m³/day between 2031 and 2039 and inflow to the open pit is predicted to fall from 1,000 m³/day in 2020 to 500 m³/day between 2031 and 2039. Following mine closure, groundwater inflow to the open pit is expected to result in a lake forming in the open pit, with the pit lake level rising to a level where groundwater inflow is balanced by evaporation from the pit lake.

An assessment of model parameter and observational uncertainty indicates a possible range of between 1,650 m³/day and 3,400 m³/day for the combined groundwater inflows into the open pit, stopes and access tunnels between 2031 and 2039.

Groundwater impacts to Lake Cowal are predicted to be negligible.

An assessment of contaminant migration, based on a conservative assessment of contaminant transport parameters, was undertaken. The assessment predicted that after 100 years the potential for groundwater quality changes due to seepage from the IWL stored water will extend a distance of up to approximately 1.7 km from the Integrated Waste Landform (IWL) walls. Cyanide is introduced to mine tailings during ore processing at a maximum concentration of 20 mg/L and is the only significant chemical in the tailings that is not derived from the host rock. Consideration of cyanide decay times indicates that cyanide concentrations are predicted to fall well below detectable limits prior to seeping outside the CGO mine area.

Table of contents

1	Introduction	1
1.1	CGO Underground Development	1
1.2	Approvals strategy	2
1.3	Scope of hydrogeological assessment	2
1.4	Secretary's Environmental Assessment Requirements	4
2	Legislation, policy and guidelines	5
3	Summary of background information	6
3.1	Available information	6
4	Regional setting	7
4.1	Topography and land use	7
4.2	Surface drainage	8
4.3	Climate	9
4.4	Mine site	11
5	Regional geology	13
5.1	Mine site geology	15
6	Hydrogeology	19
6.1	Regional hydrogeology	19
6.2	Mine hydrogeology	19
6.3	Exploration boreholes	23
6.4	Gravity survey	25
6.5	Regional groundwater levels and flow regimes	26
6.6	Local groundwater levels and flow regimes	27
6.6.1	Groundwater level monitoring	27
6.7	Groundwater levels and flow regimes within ML1535.....	30
6.7.1	Groundwater Response to tailings storage facilities	31
6.7.2	Surface Water Bodies	31
6.7.3	Groundwater Quality	33
6.8	Aquifer Parameters	35
7	Representation of mining activities.....	43
7.1	Open pit excavation schedule	43
7.2	Open pit dewatering	43
7.3	Storage dams	44
7.4	Tailings storage facilities and Integrated Waste Landform	44
7.5	Paste fill	46
7.6	Proposed underground mine.....	46
7.6.1	Mine geometry	46
8	Numerical model development.....	52
8.1	Conceptual model	52

8.1.1	Model domain, layers and discretisation	52
8.1.2	Boundary conditions	57
8.2	Model calibration	63
8.2.1	PEST	63
8.2.2	Model parameter zones.....	63
8.2.3	Parameters	63
8.2.4	Field observations	64
8.2.5	Inflow to open pit	65
8.2.6	Results.....	66
8.2.7	Assessment of calibration quality	67
8.2.8	Parameter sensitivities	69
8.2.9	Comparison of model with measured pit dewatering rates	69
8.3	Uncertainty assessment.....	70
8.4	Model classification	73
9	Predictive modelling	75
9.1	Representation of future mining activities	75
9.1.1	Open Pit.....	75
9.1.2	Open pit dewatering bores and horizontal drains	77
9.1.3	ML1535 saline groundwater supply bores	77
9.1.4	Tailings Storage Facilities and Integrated Waste Landform	77
9.1.5	Lake Cowal.....	77
9.1.6	Stopes and tunnels.....	78
9.1.7	Paste backfill	79
9.1.8	Groundwater recovery in stopes and access tunnels	79
10	Predictive modelling results.....	81
10.1	Groundwater levels during mining	81
10.2	Groundwater levels post mine closure.....	84
10.3	Groundwater inflows during mining.....	84
10.3.1	Effects of increased fracturing of rock above stopes	85
10.3.2	Effects of increased hydraulic conductivity of lake bed sediments	85
10.4	Groundwater inflows post mine closure	86
10.5	Potential impact on Lake Cowal.....	87
10.6	Groundwater quality related to open pit and stopes dewatering.....	88
10.7	Contaminant migration	88
10.7.1	Adopted porosity and retardation coefficient due to sorption.....	88
10.7.2	Decay in cyanide concentration	89
10.7.3	Modelling results	89
11	Groundwater licensing and aquifer interference policy considerations.....	92
11.1	Licensing	92
11.1.1	Mine Site Groundwater Extraction	93
11.2	Aquifer Interference Policy Requirements	94

11.2.1	Mine Site.....	94
12	Management and mitigation measures	98
12.1	Groundwater Levels around the Tailings Storage Facilities	98
13	Conclusions	99
13.1	Groundwater impacts due to open pit and underground mining.....	99
13.2	Impacts on Lake Cowal due to open pit and underground mining.....	99
13.3	Groundwater quality impacts due to potential seepage from the TSFs and IWL	100
14	Recommendations.....	101
14.1	Data and Monitoring.....	101
15	Limitations	101
15.1	Numerical simulation.....	101
16	References	102

Tables

Table 4-1:	Average rainfall and pan evaporation near the mine site
Table 6-1:	Monitoring well details
Table 6-2:	Piezometers installed in February 2020
Table 6-3:	Cyanide detections
Table 6-4:	Adopted model parameters (Coffey, 2008)
Table 6-5:	Adopted Model Parameters (Coffey, 2009a)
Table 6-6:	Adopted Model Parameters (Hawkes, 1998)
Table 6-7:	Summary of horizontal hydraulic conductivity values adopted for previous work
Table 6-8:	Summary of specific yield and storage values adopted for previous work
Table 6-9:	Tailings Permeability Data (Knight Piesold Pty Ltd, 1994)
Table 6-10:	Adopted Model Parameters (Coffey, 2009a)
Table 6-11:	Summary of TSF parameters adopted for previous work
Table 6-12:	Packer test results on boreholes drilled in 2020
Table 7-1:	TSF and IWL crest levels and low points
Table 8-1:	Calibrated parameters adopted for the current model
Table 8-2:	Parameters adopted in the MOD14 assessment (provided for comparison)
Table 8-3:	Details of model uncertainty targets, resulting objective functions and model results
Table 9-1:	Stopes and tunnels excavation sequence (tunnel areas refer to Figure 9-4)
Table 10-1:	Expected dewatering groundwater quality
Table 10-2:	Soil-water partition coefficient
Table 11-1:	Requirements for Water Sharing (Murray-Darling Basin Fractured Rock – Lachlan Fold Belt Groundwater Source)
Table 11-2:	Groundwater licensing requirement summary

Figures

Figure 4-1: Site location

Figure 4-2: Regional setting showing 10 m surface elevation contours (Satellite imagery: ESRI)

Figure 4-3: Annual and monthly rainfall since 2005 (West Wyalong Post Office, BoM station 73054)

Figure 4-4: Mine site (Aerial imagery provided by Evolution Mining)

Figure 5-1: Quaternary and Tertiary geology (Source: Seamless Geology of NSW)

Figure 5-2: Devonian and Ordovician geology (Source: Seamless Geology of NSW)

Figure 5-3: Mine site geology at 0 m AHD (based on geological model provided by Evolution Mining)

Figure 5-4: Mine site east-west cross section at 6279100N showing proposed stopes and access tunnels (based on geological model provided by Evolution Mining)

Figure 6-1: Conceptual hydrogeological model

Figure 6-2: Section locations for sections shown in Figure 6-3, Figure 6-4 and Figure 6-6 (Aerial imagery provided by Evolution Mining, December 2019)

Figure 6-3: Section AA' through the tailings storage facilities showing pre-development groundwater conditions

Figure 6-4: Section BB' through the southern tailings storage facility showing pre-development groundwater conditions

Figure 6-5: Depth to the base of Transported and Saprolite units as interpreted from exploration boreholes

Figure 6-6: Section CC' showing hydrogeological unit elevations interpreted from exploration boreholes

Figure 6-7: Thickness of the Transported unit from gravity survey interpretation

Figure 6-8: Monitoring well locations (Aerial imagery provided by Evolution Mining, December 2019)

Figure 6-9: Observed hydraulic head in December 2019 for the Transported and Saprolite units (Coffey, 2020b)

Figure 7-1: Approximate elevation of base of open pit over time

Figure 7-2: Storage dams

Figure 7-3: TSF and IWL water levels

Figure 7-4: Detailed plan view of stopes area (Aerial imagery provided by Evolution Mining, December 2019)

Figure 7-5: Stopes and access tunnels - plan view (m MGA Zone 55)

Figure 7-6: Stopes and access tunnels - elevation view looking west (Northings in m MGA Zone 55)

Figure 7-7: Stopes and access tunnels - elevation view looking south (Eastings in m MGA Zone 55)

Figure 7-8: Stopes and access tunnels - isometric view from the west

Figure 7-9: Stopes and access tunnel excavation timing

Figure 8-1: Model domain

Figure 8-2: View of the open pit and stopes elements as represented in the model, viewed from the north west

Figure 8-3: View of the stopes and open pit elements as represented in the model, viewed from underneath from the north east

Figure 8-4: Mesh

Figure 8-5: Mesh detail near open pit and stopes

Figure 8-6: Location of model boundary conditions

Figure 8-7: Model groundwater heads for 1 January 2004

Figure 8-8: Modelling of open pit excavation sequence (contours show hydraulic head, grey signifies inactive elements representing the open pit and the white line shows the water table)

Figure 8-9: Modelled base of pit elevation

Figure 8-10: Pit dewatering bores

Figure 8-11: Representation of eastern pit dewatering bores in model

Figure 8-12: Modelled crest levels (time varying fixed head boundary conditions) for the TSFs and IWL

Figure 8-13: Lake Cowal observed and modelled water levels from 1998 to 2020

Figure 8-14: Locations of piezometers used for model calibration

Figure 8-15: Observed versus modelled groundwater head

Figure 8-16: Model mass balance error (%) at selected times

Figure 8-17: Relative sensitivity of the model calibration to parameters

Figure 8-18: Pit dewatering and rainfall

Figure 8-19: Alternative sets of calibrated model parameters

Figure 9-1: Example showing contours of groundwater head are smoothed out only a short distance away from a complicated structure where a fixed head is applied (Image created using Seep/W)

Figure 9-2: Modelled groundwater head at base of open pit

Figure 9-3: Modelled TSF and IWL crest levels

Figure 9-4: Access tunnel areas

Figure 10-1: Modelled groundwater table drawdown from 2004 to 2020

Figure 10-2: Modelled groundwater table drawdown from 2004 to 2038

Figure 10-3: Modelled groundwater table drawdown from 2004 to 2058

Figure 10-4: Uncertainty in modelled groundwater table drawdown at January 2038

Figure 10-5: Predicted groundwater inflow to the open pit, stopes and access tunnels (2006 to 2138)

Figure 10-6: Predicted groundwater inflow allowing for model parameter and observational uncertainty (2022 to 2039)

Figure 10-7: Predicted groundwater inflow into each of the mine areas (2022 to 2039)

Figure 10-8: Plan view showing predicted movement of contaminants from 2038 to 2058

Figure 10-9: Section view looking north showing predicted movement of contaminants from 2038 to 2058

Figure 11-1: BoM Atlas of Groundwater Dependent Ecosystems (Aquatic)

Figure 11-2: BoM Atlas of Groundwater Dependent Ecosystems (Terrestrial)

Appendices

Appendix A - Groundwater monitoring

Appendix B - Groundwater calibration comparisons

Appendix C - Groundwater level response

Appendix D - Particle tracking

Appendix E - Field investigations report

1 Introduction

Evolution Mining (Cowal) Pty Limited (Evolution Mining) is the owner and operator of the Cowal Gold Operations (CGO) located approximately 38 kilometres north-east of West Wyalong, New South Wales (NSW). CGO is an existing open cut mine site, which has been operational since commencement in 2005, and has current approvals in place to continue processing at a rate of 9.8 million tonnes of ore per annum (Mtpa) until 2032. The existing mine site is located immediately adjacent to the ephemeral lake, Lake Cowal.

This report presents the Hydrogeological Assessment conducted by Coffey Services Australia Pty Ltd (Coffey) for Evolution Mining's CGO Underground Development EIS (UG EIS). This report addresses the effects within the area surrounding Mining Lease (ML) 1535.

A companion report has been prepared addressing the effects of the mining operation at a regional scale including the water supply borefields (Coffey report no. SYDGE206418-3-AN dated 27 August 2020).

1.1 CGO Underground Development

The area of land to which the CGO Underground Development Consent (DA 14/98) is relevant includes ML1535, ML1791 and the CGO water supply pipeline and Bland Creek Palaeochannel Borefield. Open pit mining operations are currently undertaken within ML1535, which encompasses approximately 2,636 hectares (ha). Evolution Mining seeks to extend mining operations at the CGO by way of an underground development, which would be wholly contained within ML1535. The Underground Development proposal seeks approval for construction and operation of an underground mine at the CGO to extract the GRE46 mineralisation which is located in close proximity to the existing open pit.

Key features of the CGO Underground Development include:

- A box-cut entry to the underground workings;
- A decline from the box-cut to provide access for personnel and maintenance;
- Six access points to the decline for access, ore haulage, ventilation circuit, underground services and emergency egress;
- A network of underground tunnels to provide access to the ore, transportation to the surface and ventilation;
- Use of sub-level open stoping to extract the ore;
- Production of up to 27 Mt of ore at a rate of 1.8 Mtpa;
- Production of approximately 5.74 Mt of waste rock;
- Stopes to be fully backfilled with paste material made from dewatered tailings and cement;
- Delivery of extracted ore and waste rock to the surface by truck;
- Development of a paste fill plant, and the delivery of paste fill via a borehole and the backfilling of underground stopes with the paste; and
- Development of ancillary underground infrastructure to support the underground operation, including dewatering infrastructure, ventilation system, electrical reticulation.

The following two components are part of Modification 16, which is a modification to an existing approval:

- Extension of mine life from 2032 to 2040;
- A height increase from 245 m AHD to 246 m AHD to the final rehabilitated height of the integrated waste landform.

1.2 Approvals strategy

To facilitate the Underground Development environmental impact assessment process, Evolution Mining proposes to seek approval under the NSW Environmental Planning and Assessment Act 1979 (EP&A Act) for two separate but inter-related applications:

- Underground workings EIS (UG EIS) – a State Significant Development (SSD) application under section 4.38 of the EP&A Act for the new underground component of the Underground Development. This document represents the Scoping Report that supported the request for SEARs for the SSD application.
- Surface changes modification – a request for modification (Modification 16) to the existing CGO development consent (DA 14/98) under section 4.55 of the EP&A Act for the ancillary surface changes associated with the Underground Development.

1.3 Scope of hydrogeological assessment

The objective of this hydrogeological assessment is to provide an assessment of potential impacts associated with the UG EIS, consistent with the requirements outlined in the NSW Department of Planning and Environment (DP&E) Secretary's Environmental Assessment Requirements (SEARs) for the development issued on 27 September 2019, application number SSD-10367.

This report builds upon work carried out for a hydrogeological assessment to assess the impacts of the mining operations in relation to changes proposed in CGO Modification 14 (Coffey, 2018a and Coffey, 2018b).

The key tasks undertaken for this Mine Site Hydrogeological Assessment comprise:

- Characterisation of the hydrogeological environment, including climate, topography, regional geology, mine geology, regional hydrology and hydrogeology.
- Collation and review of existing data, including:
 - Groundwater monitoring data, including groundwater level and groundwater quality results from bores located within the ML (i.e., proximal to the tailings storage facilities, waste rock emplacements, and open pit).
 - Past pit dewatering rates and groundwater drawdown monitoring results.
 - Additional geological data from resource drilling and survey.
- A review of the supplementary investigations undertaken for the UG EIS, which included:
 - Drilling of four vertical boreholes of up to 100 m depth below ground surface near the proposed underground development, with three piezometers installed in each borehole to monitor pore pressures at different depths.
 - Hydraulic testing (packer tests) in the vertical boreholes.

- Drilling and installation of 12 horizontal boreholes at three locations along the GRE46 exploration decline to measure pore pressures at various distances away from the decline.
- Identification of Groundwater Dependent Ecosystems (GDEs) in the region, based on the Bureau of Meteorology (BoM) GDE Atlas;
- Development of a hydrogeological conceptual model, including:
 - Discussion on the proposed modelling approaches to support groundwater impact assessment for the UG EIS, with a description of the mine area groundwater setting covering:
 - Recharge mechanisms.
 - Hydrogeological boundaries.
 - Hydrogeological units.
 - Hydraulic properties.
 - Influence of the flood events and periodic inundation of Lake Cowal.
 - Groundwater quality.
 - Mine groundwater inflows.
- Development and calibration of a 3D numerical groundwater model to model conditions relevant to the proposed underground development and expanded IWL.
- Predictive modelling to assess the following for the CGO Underground Development and Modification 16:
 - Potential changes to the hydrogeological regime as a result of underground mining and expanded IWL.
 - Potential groundwater drawdown associated with the underground mine and open pit dewatering.
 - Expected inflow rates to the underground mine and open pit.
 - Impacts on seepage from Lake Cowal due to the development.
 - Potential seepage rates from the tailings storage facilities (TSF) including the expanded IWL.
 - Groundwater drawdown impacts on Lake Cowal.
 - Transport of contaminants from the IWL after mine closure (adopting a particle tracking method) at 20, 50, 100 and 200 years post-mine closure.
- Sensitivity of modelling results to selected model parameters will be discussed, consistent with contemporary groundwater modelling guidelines.
- A model uncertainty assessment which includes a discussion on the key assumptions influencing model uncertainty and a quantitative assessment of model results for alternate sets of calibrated model parameters.
- Discussion relating to the underground mine and open pit dewatering, including:

- The groundwater regime resulting from the mine operation and discussion of potential contaminant migration from the TSF and IWL.
- Expected inflow rates to the underground mine and open pit, based on predictive modelling.
- Discussion on the connectivity between the Lake Cowal surface water and the proposed underground mine and open pit, and potential impacts on Lake Cowal.
- Potential groundwater drawdown associated with open pit and underground dewatering, based on the predictive modelling.
- Commentary relating to potential drawdown effects against criteria noted in the Department of Primary Industries NSW Aquifer Interference Policy (September 2012).
- Qualitative assessment of the expected groundwater quality of water discharging into the underground mine and open pit.
- Qualitative assessment of impacts on groundwater quality due to open pit and underground mine dewatering.
- Discussion relating to tailings and waste rock emplacement seepage, including:
 - Assessment of predicted seepage rates from the tailings storage facilities including the expanded IWL, based on predictive modelling.
 - Qualitative assessment of the potential groundwater quality impacts down gradient of the tailings storage facilities due to seepage of stored water. Assessed groundwater quality impacts will be reviewed in the context of future groundwater quality monitoring results.
- Discussion relating to mine closure, based on the predictive modelling and including assessment of:
 - The potential groundwater flow impacts on Lake Cowal after mine closure.
 - Potential contaminant migration from the TSFs and IWL post mine closure.
 - Groundwater level recovery in the vicinity of the underground mine and open pit.
- Review of groundwater licensing information, including required licences, allocations and the influence of regulatory constraints, and description of water licensing requirements under the Water Sharing Plan for the Lachlan Unregulated and Alluvial Water Sources, 2012 and the Water Sharing Plan for the NSW Murray-Darling Basin Fractured Rock Groundwater Sources, 2012.
- Discussion of potential measures to manage, mitigate or avoid the potential impacts of the underground operation on groundwater in ML1535 and neighbouring areas.

1.4 Secretary's Environmental Assessment Requirements

The SEARs for the UG EIS (provided on 27 September 2019, application number SSD-10367) included the following requirements related to groundwater:

- An assessment of the likely impacts of the development on the quantity and quality of regional surface water and groundwater resources;
- An assessment of the likely impacts of the development on aquifers, watercourses, riparian land, water-related infrastructure, and other water users;

- Water supply arrangements for the development;

The SEARs also nominate a number of policies, plans and guidelines, to be considered during the preparation of this report, as outlined in Section 2.

2 Legislation, policy and guidelines

This assessment has been prepared with consideration of the following policies, guidelines and plans:

- National Water Quality Management Strategy Guidelines for Groundwater Protection in Australia (Australian and New Zealand Environment and Conservation Council, 1995).
- NSW Protection of the Environment Operations Act 1997.
- The NSW State Groundwater Policy Framework Document (NSW Department of Land and Water Conservation [DLWC], 1997).
- The NSW State Groundwater Quality Protection Policy (DLWC, 1998).
- The NSW Groundwater Dependent Ecosystem Policy (DLWC, 2002).
- NSW Aquifer Interference Policy (NOW, 2012).
- Australian Groundwater Modelling Guidelines (Barnett et al., 2012).
- Guidelines for the Assessment and Management of Groundwater Contamination (Department of Environment and Conservation NSW, 2007).

3 Summary of background information

3.1 Available information

The conceptual and numerical groundwater models described in this report were developed based on the following information provided by Evolution Mining:

- Exploration borehole logs for the proposed underground mine.
- Mine site geological model containing lithology and structure.
- Geophysical gravity survey data.
- Open pit shell design for 2020 to 2024.
- Underground stoping geometry.
- Underground access and haulage tunnel geometry.
- Underground stoping and access tunnel scheduling and extraction volumes.
- GRE46 exploration decline geometry.
- TSF and IWL crest levels.
- Groundwater monitoring records for observation wells in ML1535.
- Mine site dewatering records from 2005 to 2019.

In addition, this report has been prepared taking into consideration previous reports completed by Coffey and others including information provided by the CGO (i.e. Evolution and previous owners of the mine). The principal reports referred to were:

- CGO Underground Development EIS, Groundwater site investigations report, Coffey Report No. SYDGE206418-3-AJ, dated 6 April 2020.
- Groundwater Monitoring Review 2019, Cowal Gold Operation, Coffey Report No. 754-SYDGE270760-AA, dated 30 April 2020.
- Cowal Gold Operations Processing Rate Modification (MOD14), Mine Site Hydrogeological Assessment, Coffey Report No. 754-SYDGE206418-AA, dated 2 March 2018.
- Cowal Gold Operations Processing Rate Modification (MOD14), Bland Creek Palaeochannel Borefield and Eastern Saline Borefield Groundwater Assessment, Coffey Report No. 754-SYDGE206418-BCPB, dated 24 March 2018.
- Cowal Gold Project Geotechnical Investigation Report. SNC-Lavalin Australia Report No. 334371-0000-4GRA-0001 prepared for Barrick Gold of Australia.
- Cowal Gold Mine, Groundwater Level Investigation, Coffey Report No. GEOTLCOV21910AF-AB, dated 26 March 2009.
- Cowal Gold Mine, Pit Dewatering Assessment, Coffey Report No. GEOTLCOV21910AC-AC, dated 5 August 2008.

4 Regional setting

The CGO site is located approximately 350 km west of Sydney and 38 km north east of the town of West Wyalong, NSW. The location of the mine is shown in Figure 4-1.

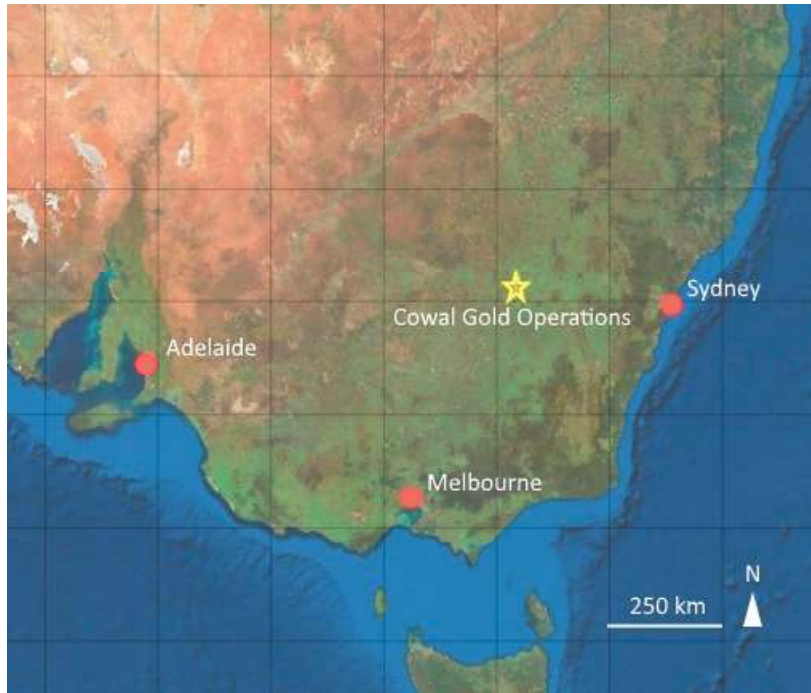

Figure 4-1: Site location

4.1 Topography and land use

The region is characterised by a flat landscape with very low undulating hills and occasional rocky outcrops. The majority of vegetation in the area has been cleared, with most of the cleared areas used for agriculture. Remnant and secondary vegetation is restricted to elevated rocky areas (SNC-Lavalin Australia, 2003).

Figure 4-2 shows the topography and rivers of the area. The terrain falls gradually from the north-east (Lachlan Floodplain) and south-east (upper Bland Creek Palaeochannel) towards Lake Cowal. Lake Cowal forms a local depression which fills with floodwater every few years.

The floodplains around Lake Cowal, north to Nerang Cowal and south to Marsden have a surface elevation of approximately between 205 m AHD and 210 m AHD. Hills formed by rock outcrops on the fringes of the floodplains reach over 300 m AHD. The Bland Creek Palaeochannel Borefield area has an elevation of just under 210 m AHD.

The Australian Natural Resources Atlas (2009) indicates land use across the region surrounding the CGO site includes livestock grazing, dryland and irrigation agriculture, and unclassified water bodies.

Within the Lachlan River Valley, livestock grazing comprises 69% of land use, followed by dryland agriculture at 22%, nature conservation area at 4% and other uses at 5% (Australian Natural Resources Atlas, 2009).

4.2 Surface drainage

Lake Cowal is an ephemeral shallow freshwater lake that is predominantly dry, with water influx during severe rainy seasons (SNC-Lavalin Australia, 2003). The pit envelope encroaches on the lake area, and a lake protection bund was constructed as part of the initial mine development. The lake is filled by runoff from the Bland Creek catchment to the south and flood breakout from the Lachlan River to the north. Lake Cowal is located within the Bland Creek Valley, a major tributary of the Lachlan River system. The lake overflows into Nerang Cowal, another ephemeral lake to the north, and then into Bogandillon Swamp before flowing to the Lachlan River. Prior to the drought conditions that occurred last decade, the lake was observed to contain some water in seven years out of ten. Since 1998, Lake Cowal has filled on three occasions: late 2010, 2012 and again in 2016 (Hydro Engineering & Consulting Pty Ltd, 2018).

Watercourses in the area (with the exception of the Lachlan River) are intermittent. Bland and Barmedman Creeks are the largest of the local creeks, refer to Figure 4-2). They form ephemeral tributaries to Lake Cowal, flowing in from the south. An extensive irrigation canal system is present within the Bland Creek Palaeochannel area and to the north. These canals deliver water from the Lachlan River to irrigators to sustain the agricultural industry in this area.

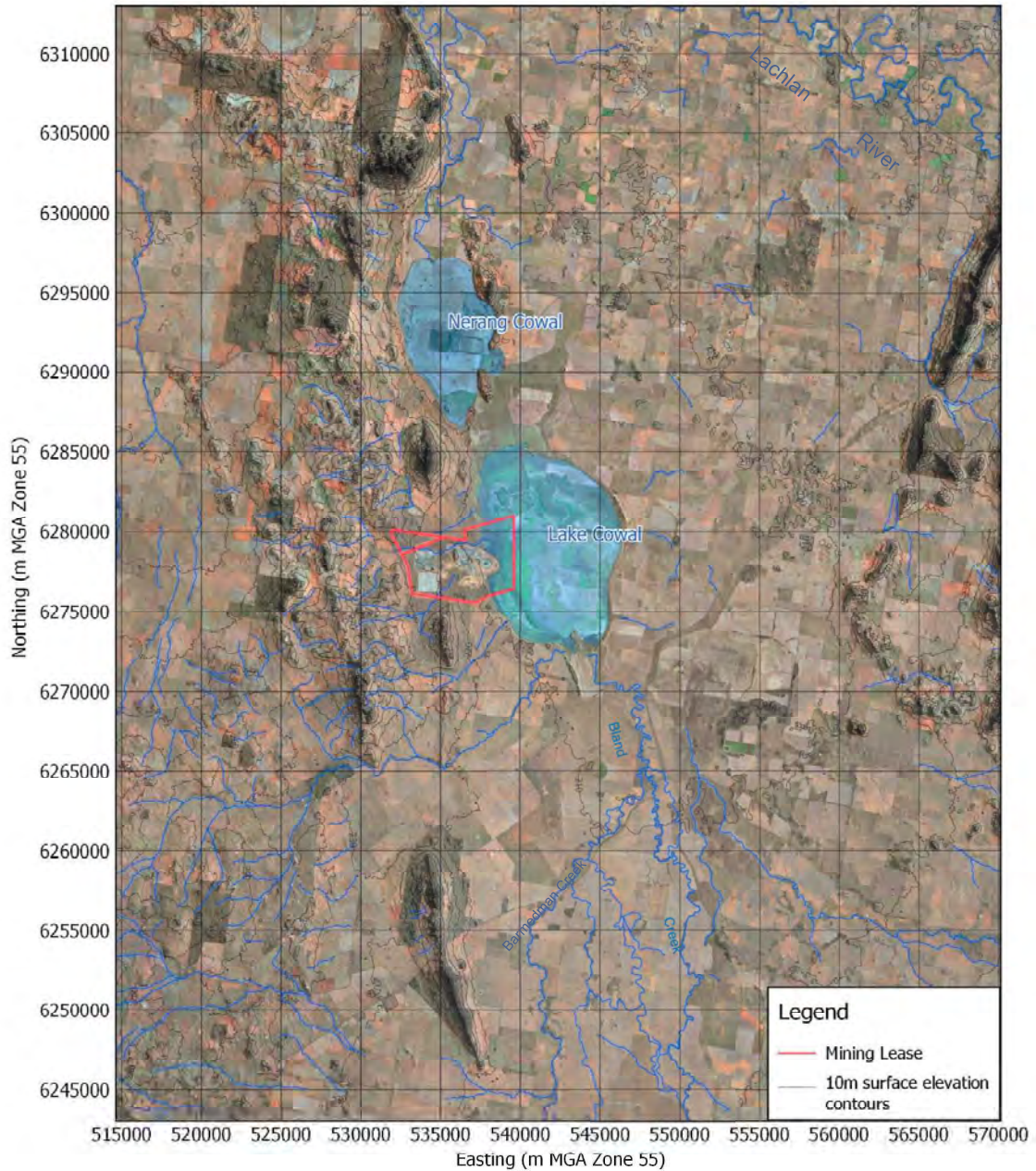

Figure 4-2: Regional setting showing 10 m surface elevation contours (Satellite imagery: ESRI)

4.3 Climate

The closest rainfall station to the study area with long-term records is Station 73054 (Wyalong Post Office), operated by the Bureau of Meteorology (BoM) and located approximately 32 km south of ML1535. Table 4-1 lists the average and median monthly rainfall for this station for the years 1895 to 2019. There was no data between 1939 and 1948. The average annual rainfall is 479 mm.

The closest climate station within with reasonable amounts of pan evaporation data is BoM Station 050052 (Condobolin Agricultural Research Station), located about 75 km away. Table 4-1 lists the

average monthly pan evaporation for the station over the period 1973 to 2017. The average annual pan evaporation is 1971 mm.

Table 4-1: Average rainfall and pan evaporation near the mine site

Month	Rainfall WYALONG POST OFFICE - 073054		Pan evaporation: CONDOBOLIN AG RESEARCH STN - 050052
	Mean (mm)	Median (mm)	Mean (mm)
Jan	41	27	310
Feb	38	22	244
Mar	38	23	211
Apr	34	24	129
May	39	30	74
Jun	43	35	48
Jul	42	38	50
Aug	39	38	78
Sep	37	29	117
Oct	45	37	180
Nov	37	35	234
Dec	44	31	298
Annual	479	473	1971

Source: Bureau of Meteorology

Average rainfall data shows no seasonal trend. Pan evaporation is a maximum in summer months and a minimum in winter. A rainfall deficit occurs for all months except June and July. Average annual pan evaporation is over four times the average annual rainfall.

Annual and monthly rainfall from 2005 to 2019 at BoM Station 73054 is shown in Figure 4-3. Note the higher rainfall years of 2010, 2011 and 2016 and the drier periods of 2006 to 2008 and 2015 to 2018, excluding 2016. Cumulative monthly rainfall residual is also shown in Figure 4-3. This is a measure of the accumulated deficit or surplus of rainfall at a particular time, relative to average annual rainfall. Low rainfall periods are characterised by falling cumulative rainfall residual while high rainfall periods are represented by a rising trend. The sustained drought from 2005 to 2010 is clearly evident as is the more recent drought from 2017 to 2020.

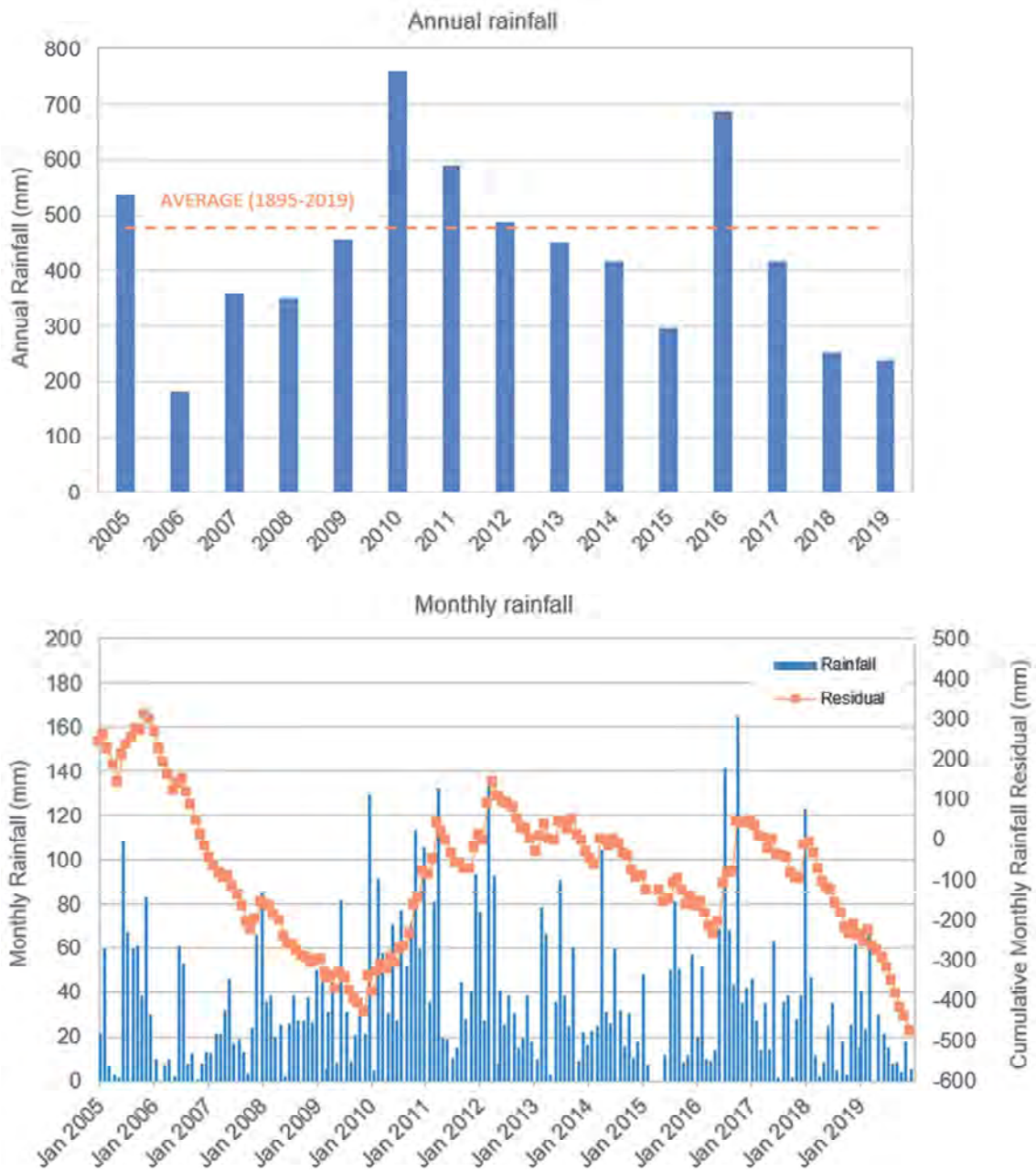

Figure 4-3: Annual and monthly rainfall since 2005 (West Wyalong Post Office, BoM station 73054)

4.4 Mine site

The CGO is located in the Bland Creek Valley, on the western margin of the Bland Creek Palaeochannel Plain, which is approximately 20 km to 30 km wide and bounded by the following:

- Bland Creek Palaeochannel and Jemalong Range (Tullamore Syncline) to the east.

- Manna Anticline and its associated ridge, together with the regionally extensive Gilmore Suture/Gilmore Fault Zone, located to the west of Lake Cowal.
- Lachlan River to the north.
- Bland Creek catchment to the south.

The site includes the following infrastructure, as shown in Figure 4-4:

- An open pit in the east of the site.
- A perimeter waste rock emplacement and lake protection bund running beyond, and around the open pit.
- The waste rock emplacements to the north-west and south-west of the open pit.
- A processing plant located to the west of the open pit.
- A number of contained water storages at various locations across the site. D1, D3 and D9 are shown on the figure.
- Tailings storage facilities comprising two storage dams with approximate dimensions of 1,300 m by 1,300 m in the west of ML1535, which are to be integrated into the IWL.

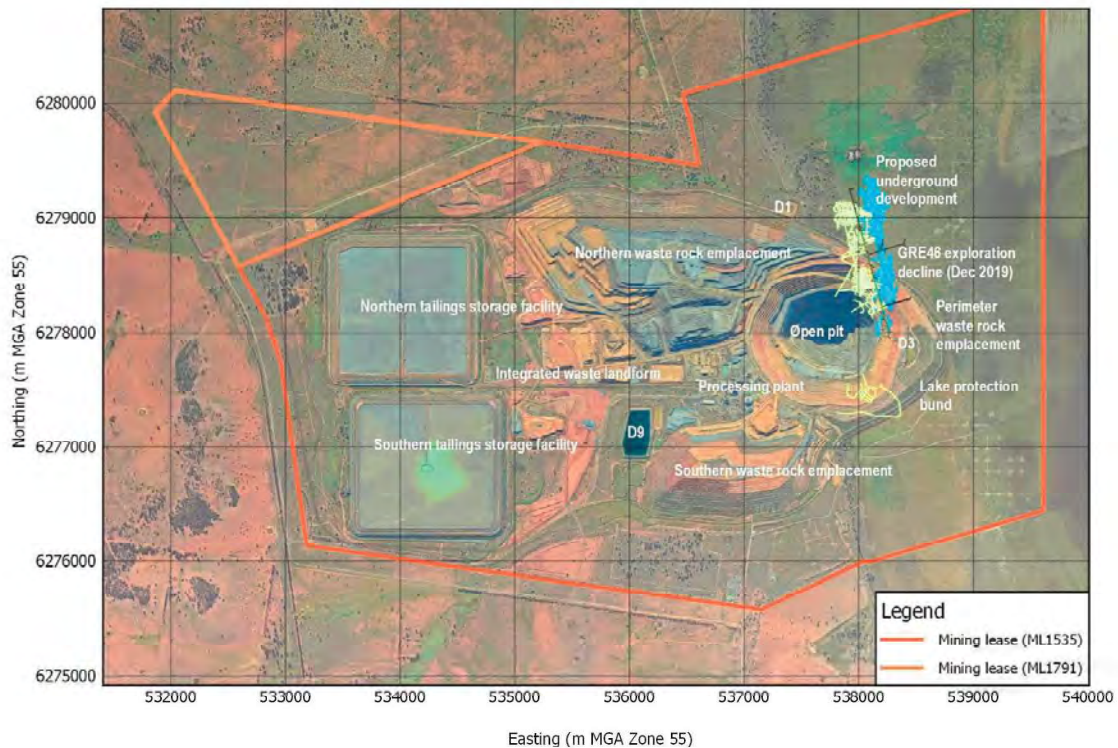

Figure 4-4: Mine site (Aerial imagery provided by Evolution Mining)

5 Regional geology

The Forbes 1:250,000 Geological Map shows that the regional geological setting is dominated by the Gilmore Fault Zone also called the Gilmore Suture, a structurally and lithologically complex feature that trends north-south through ML1535, approximately 500 m west of the CGO open pit.

The fault separates a Late Ordovician volcanoclastic sequence (referred to as the Lake Cowal Volcanic Complex) from the Siluro Devonian sedimentary basement to the west. Siluro Devonian sedimentary rocks also occur east of the Lake Cowal Volcanic Complex on the eastern side of Lake Cowal, where the basement has been deeply incised and hosts palaeochannel deposits of the Bland Creek unit.

The region is covered by varying thicknesses of Tertiary and Quaternary regolith deposits. The Bland Creek Palaeochannel Plain was formed by the infilling of the Lachlan and Bland Creek Palaeochannels, located to the north and east of Lake Cowal, respectively, with sediments of the Lachlan and Cowra Formations. The depth of these sediments is over 100 m. Locally, Pleistocene Cowra alluvium overlies ML1535 and thick Quaternary lacustrine sediments underlie Lake Cowal.

The geology of the CGO site and surrounds is illustrated in Figure 5-1 and Figure 5-2.

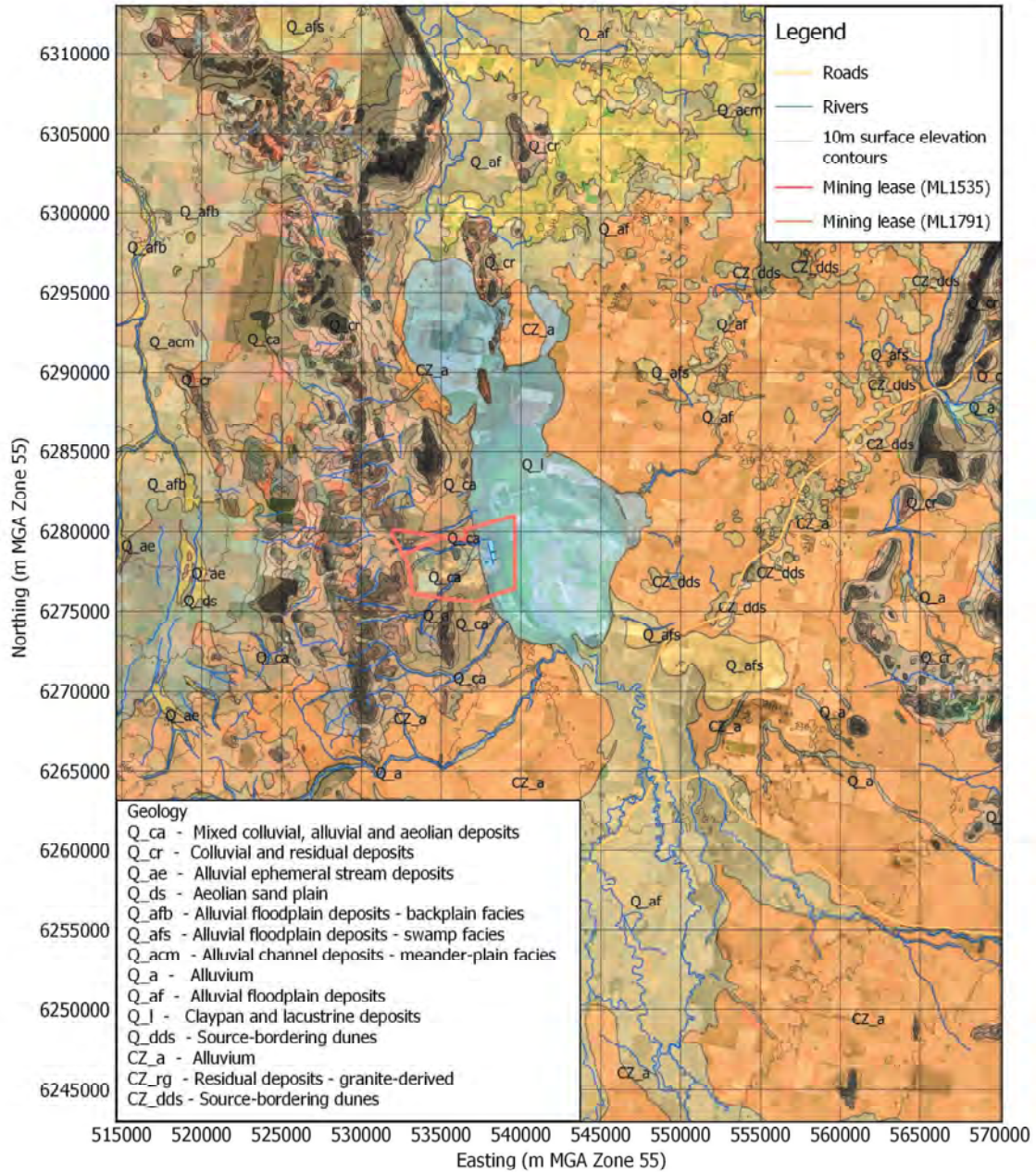

Figure 5-1: Quaternary and Tertiary geology (Source: Seamless Geology of NSW)

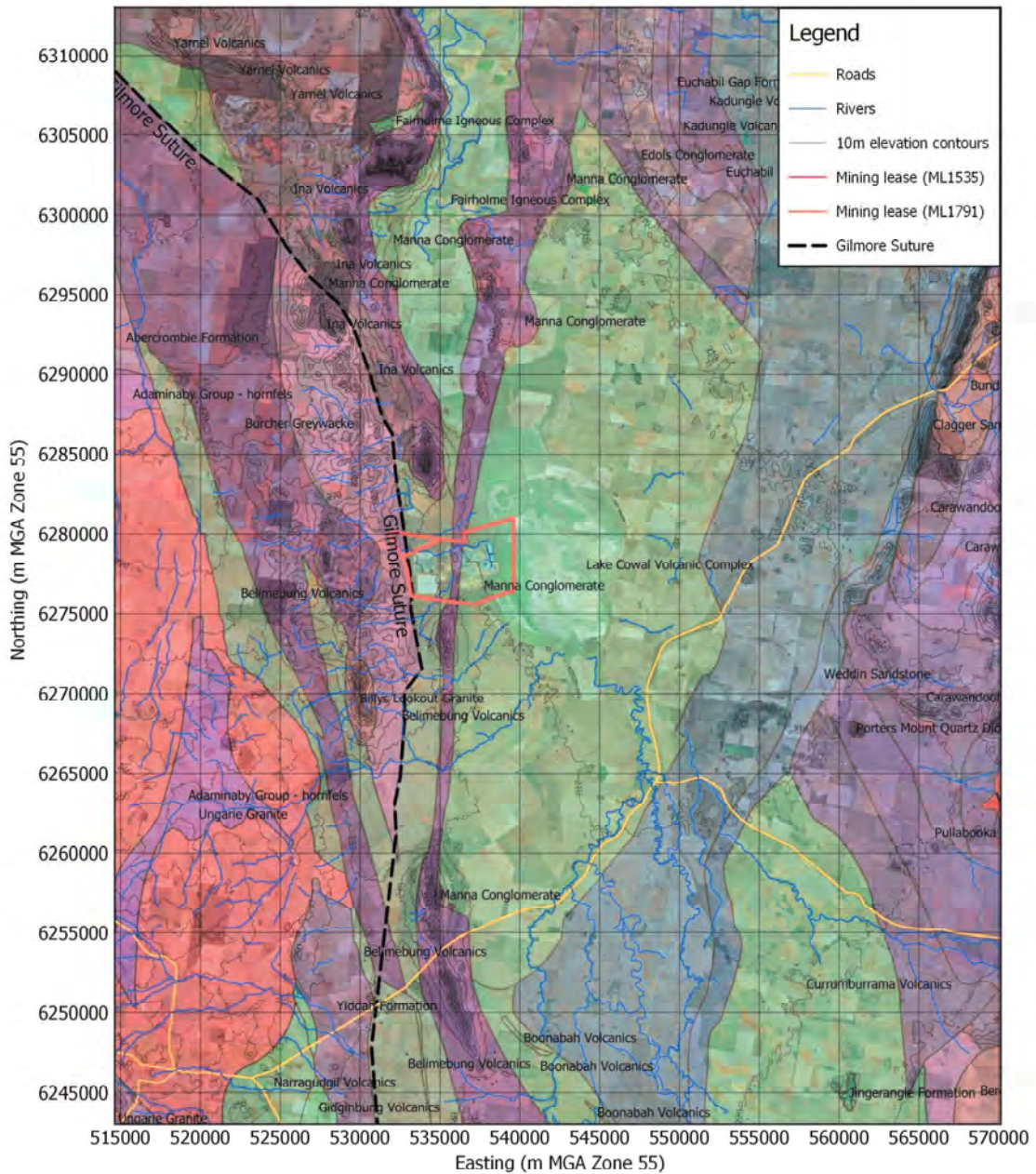

Figure 5-2: Devonian and Ordovician geology (Source: Seamless Geology of NSW)

5.1 Mine site geology

The CGO site lies within the Lake Cowal Volcanics, which comprise massive and stratified non-welded pyroclastic debris, overlying a partly brecciated lava sequence, overlying volcanic conglomerate interbedded with siltstone and mudstone. The stratigraphic units at the site consistently strike at 215° and dip 50° to the north-west (Miles and Brooker, 1998).

Within the Lake Cowal Volcanic Complex are diorite and gabbro intrusions, one of which is intersected by the CGO open pit. Within the ore body there are several north-south oriented, near vertically dipping faults and fractured dykes.

Overlying the Ordovician host rock is a Tertiary age laterite, which averages approximately 20 m and varies in thickness across the CGO site, from approximately 15 m to 55 m. Quaternary age sediments of predominantly lacustrine clay characteristically cover the Tertiary laterite. The depth of sediments across the CGO site and surrounds ranges from approximately 14 m to 55 m. This is consistent with thickness of the Transported Alluvium (Lower Cowra and Upper Cowra Formations) utilised in a calibrated groundwater model developed by NOW (NSW Office of Water, now the Department of Primary Industries – Crown Lands and Water [CL&W]), in which values of over 20 m were adopted over the CGO site and surrounds.

A three-dimensional mine geological model was provided by Evolution Mining. Data from this model was used to produce Figure 5-3 and Figure 5-4 which show the rock units and major faults present at the mine site.

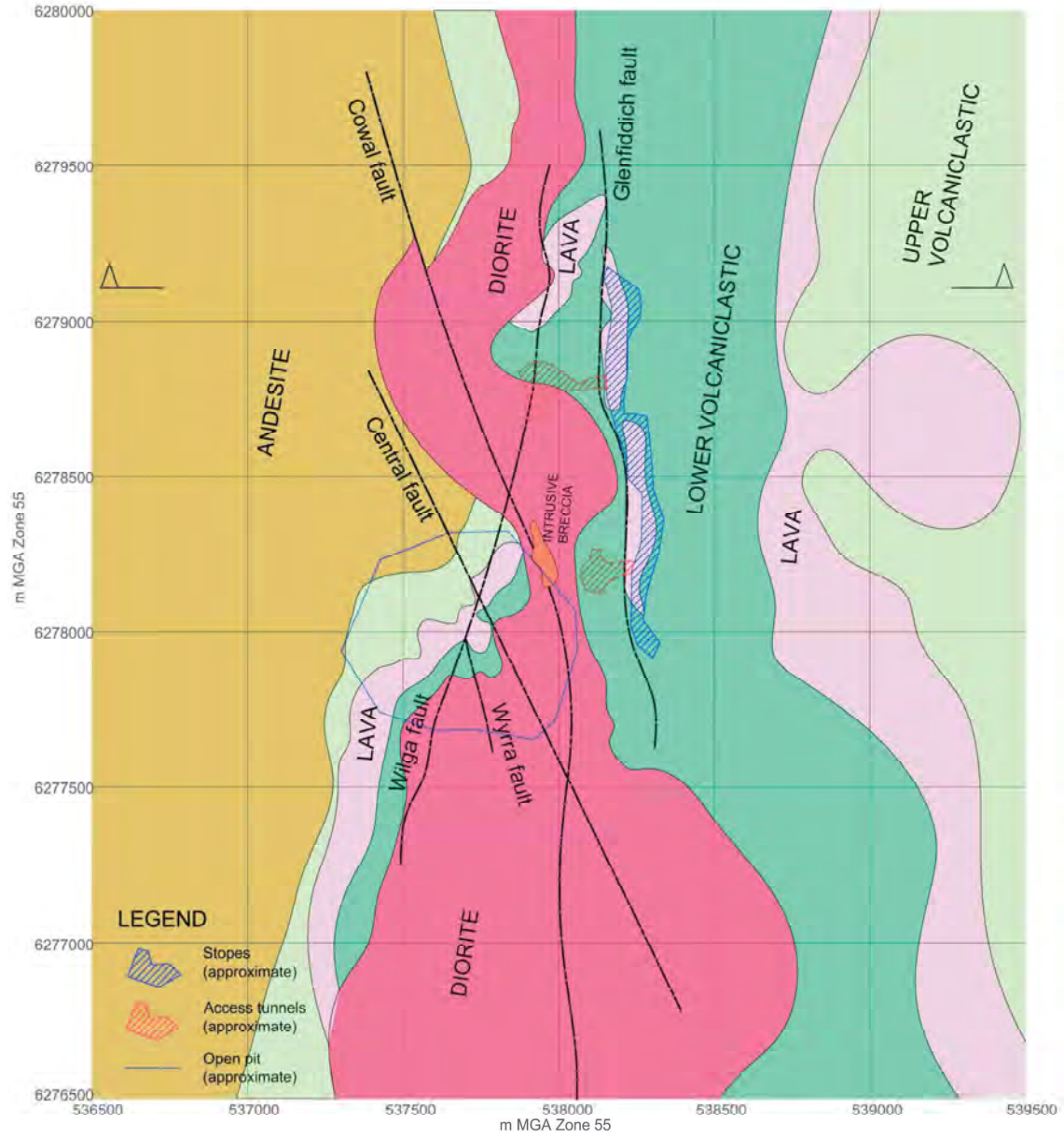

Figure 5-3: Mine site geology at 0 m AHD (based on geological model provided by Evolution Mining)

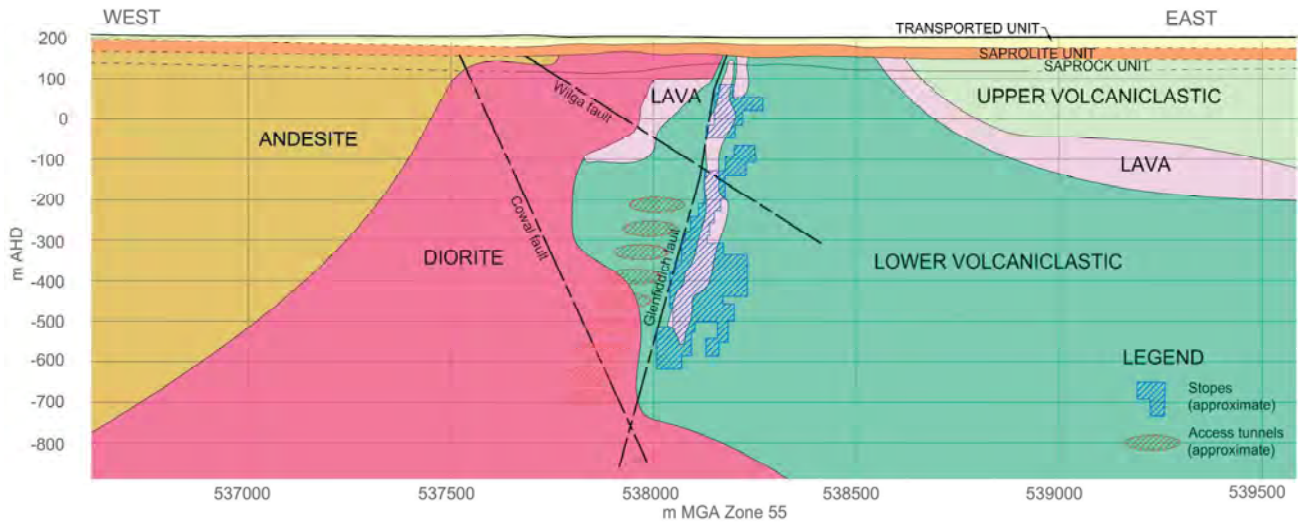

Figure 5-4: Mine site east-west cross section at 6279100N showing proposed stopes and access tunnels (based on geological model provided by Evolution Mining)

6 Hydrogeology

6.1 Regional hydrogeology

Regionally, groundwater resources are present in the Bland Creek Palaeochannel, and include the following two geological formations:

- Cowra Formation: Comprising isolated sand and gravel lenses in predominantly silt and clay alluvial deposits, with groundwater of generally higher salinity.
- Lachlan Formation: Comprising quartz gravel with groundwater of generally low salinity.

Three distinct alluvial sequences were interpreted to be present, based on the distribution of hydraulic conductivity with depth as assessed by Coffey (2006). These are as follows:

- Upper Cowra Formation: This sequence generally occurs from ground surface to an average depth of approximately 45 m to 50 m over most of the CGO site and surrounding area. The average depth to groundwater is approximately 7 m, giving an average saturated thickness of just over 40 m (Coffey, 2006). The data suggest the Upper Cowra sequence generally shows decreasing hydraulic conductivity with depth and greater stratification than that found in deeper layers.
- Lower Cowra Formation: This sequence generally occurs over an average depth interval of approximately 50 m to 90 m over most of the CGO site and surrounding area. This layer appears to have lower horizontal hydraulic conductivity values than the Upper Cowra Formation.
- Lachlan Formation: This sequence generally occurs over an average depth interval of around 90 m to 120 m in the Bland Creek Palaeochannel. Within this formation there were assessed to be two distinct sequences, including:
 - High permeability sands and minor gravels close to, and within, the deeper parts of the palaeochannel.
 - Lower permeability sediments that generally occur further away from the deeper parts of the palaeochannel and surround the high permeability sands and minor gravels. The average hydraulic conductivity of this sequence appears similar to the Lower Cowra Formation.

Coffey (2006) interpreted that the western limit of the Cowra Formation extends within the eastern boundary of ML1535, but that the Lachlan Formation did not extend into ML1535. Pre-mining groundwater flow was generally from east to west under a hydraulic gradient of approximately 0.1%, increasing to 0.3% further west.

Geological data available from the Bland Creek Palaeochannel Borefield to the north-east of the CGO site and from the Bland Creek system to the south-east of the CGO site have also been used in characterising the regional hydrogeology.

6.2 Mine hydrogeology

Locally, at the CGO site, four hydrogeological units have been identified:

- The Transported unit: Comprising alluvium (thick clay sequences and more permeable zones of gravel within a sandy clay matrix) of the Quaternary-aged Cowra Formation. The Cowra Formation is laterally equivalent to the Transported unit (Barrick Australia Limited, 2010).
- The Saprolite unit: Underlies the Transported unit and is of relatively low hydraulic conductivity. The unit comprises extremely weathered rock, often weathered to clay.

- The Saprock unit: Underlies the Saprolite unit and occurs in the weathered fractured surface of the Lake Cowal Volcanics. The unit comprises highly to moderately weathered rock with some zones of clay.
- The Primary Rock unit: Consisting of slightly weathered to fresh rock underlying the Saprock unit. This unit is generally considered to be less fractured and less permeable than the Saprock.

Coffey (2009a) developed geological cross-sections through the western area of the CGO site. The locations of the cross-sections are shown on Figure 6-2 and the cross-sections are shown on Figure 6-3 and Figure 6-4. The extent of the Saprolite and Saprock units outside the CGO site are not defined.

Figure 6-1 presents a simplified conceptual cross-section through approximately the centre of the CGO open pit.

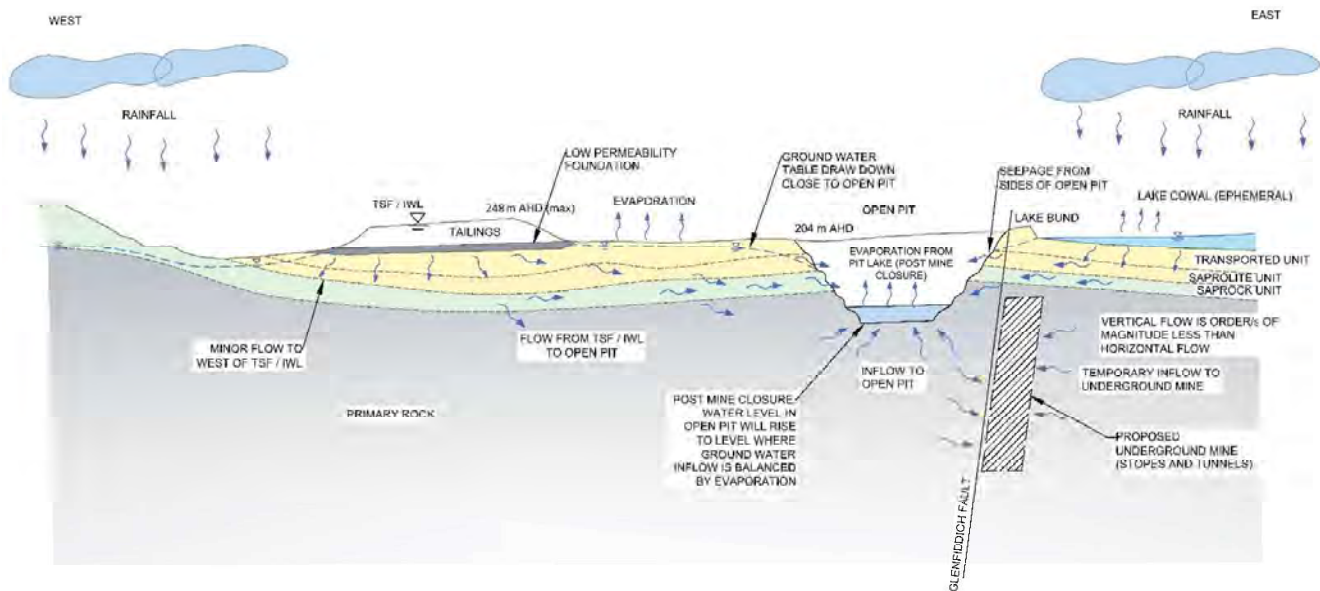

Figure 6-1: Conceptual hydrogeological model

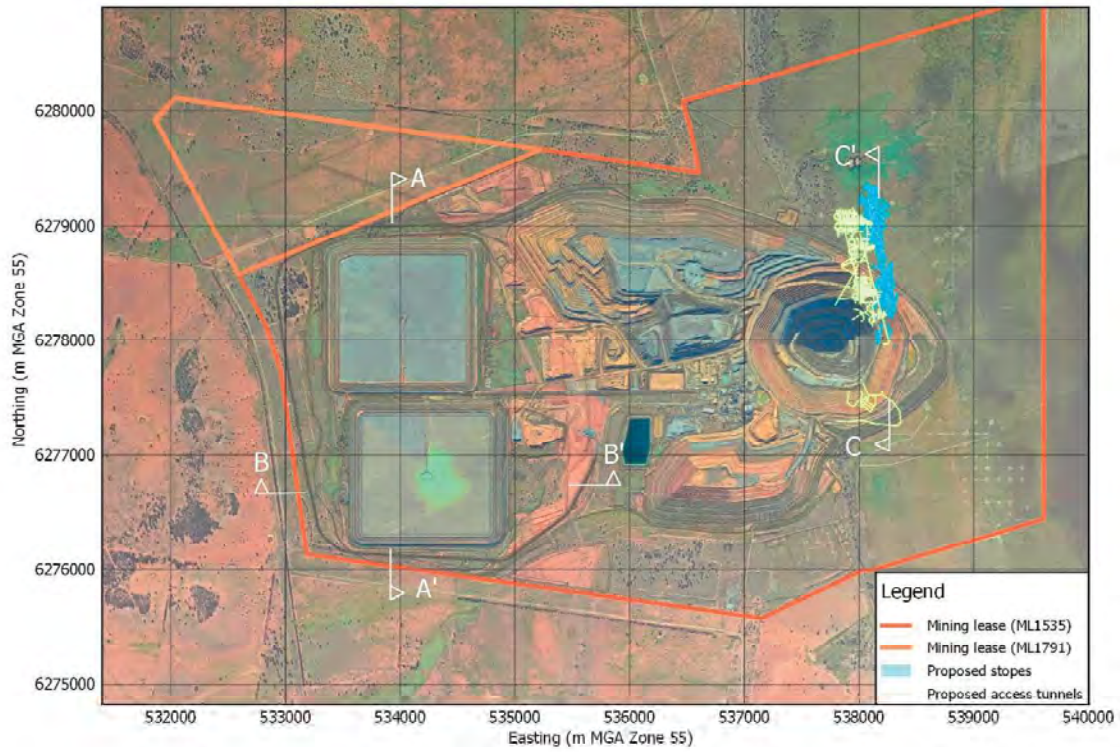

Figure 6-2: Section locations for sections shown in Figure 6-3, Figure 6-4 and Figure 6-6 (Aerial imagery provided by Evolution Mining, December 2019)

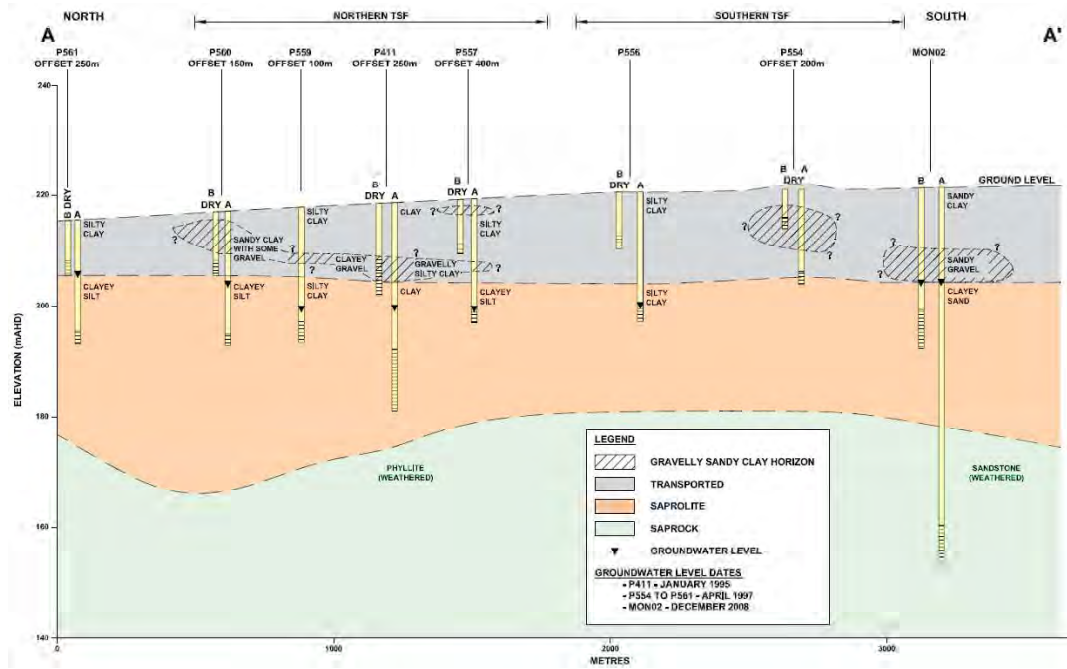

Figure 6-3: Section AA' through the tailings storage facilities showing pre-development groundwater conditions

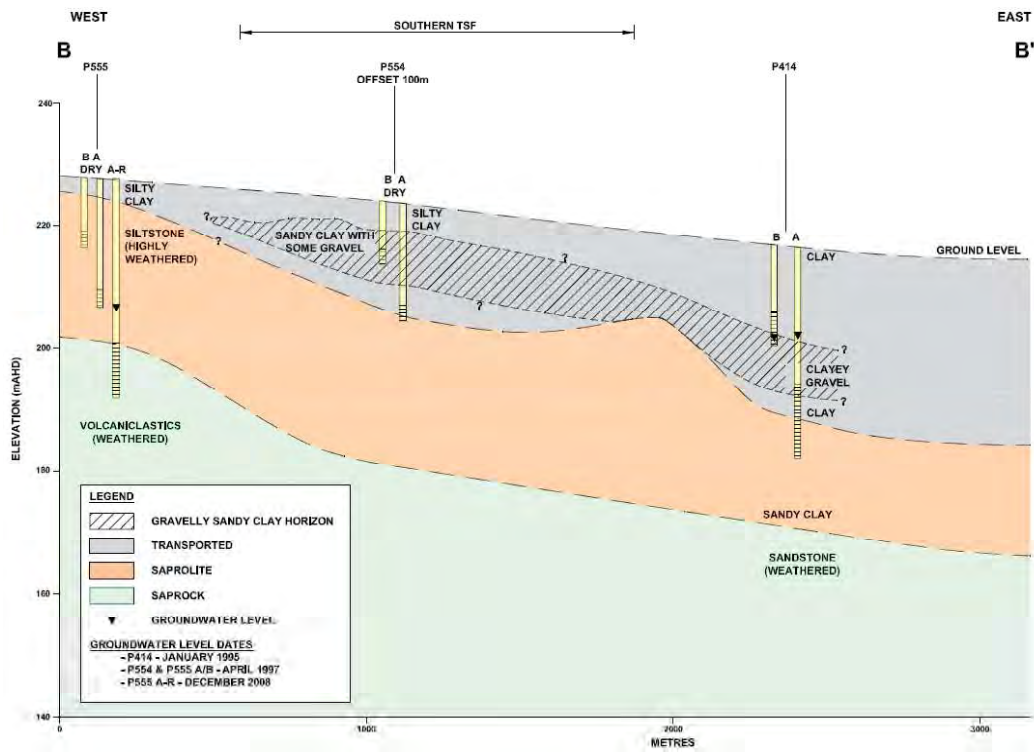

Figure 6-4: Section BB' through the southern tailings storage facility showing pre-development groundwater conditions

6.3 Exploration boreholes

Exploration borehole data was provided in digital format by Evolution Mining. The provided exploration boreholes cover an area of approximately 1.3 km (east-west) by 2.5 km (north-south) above the proposed underground mine, as shown in Figure 6-5. This data was used to obtain elevations for the interfaces between the three hydrogeological units described above. A contouring process (kriging) was used to interpolate between boreholes. Figure 6-5 shows the interpreted depth below ground of the Transported and Saprolite units from the exploration boreholes. The depth below ground refers to the ground surface prior to the open pit being excavated.

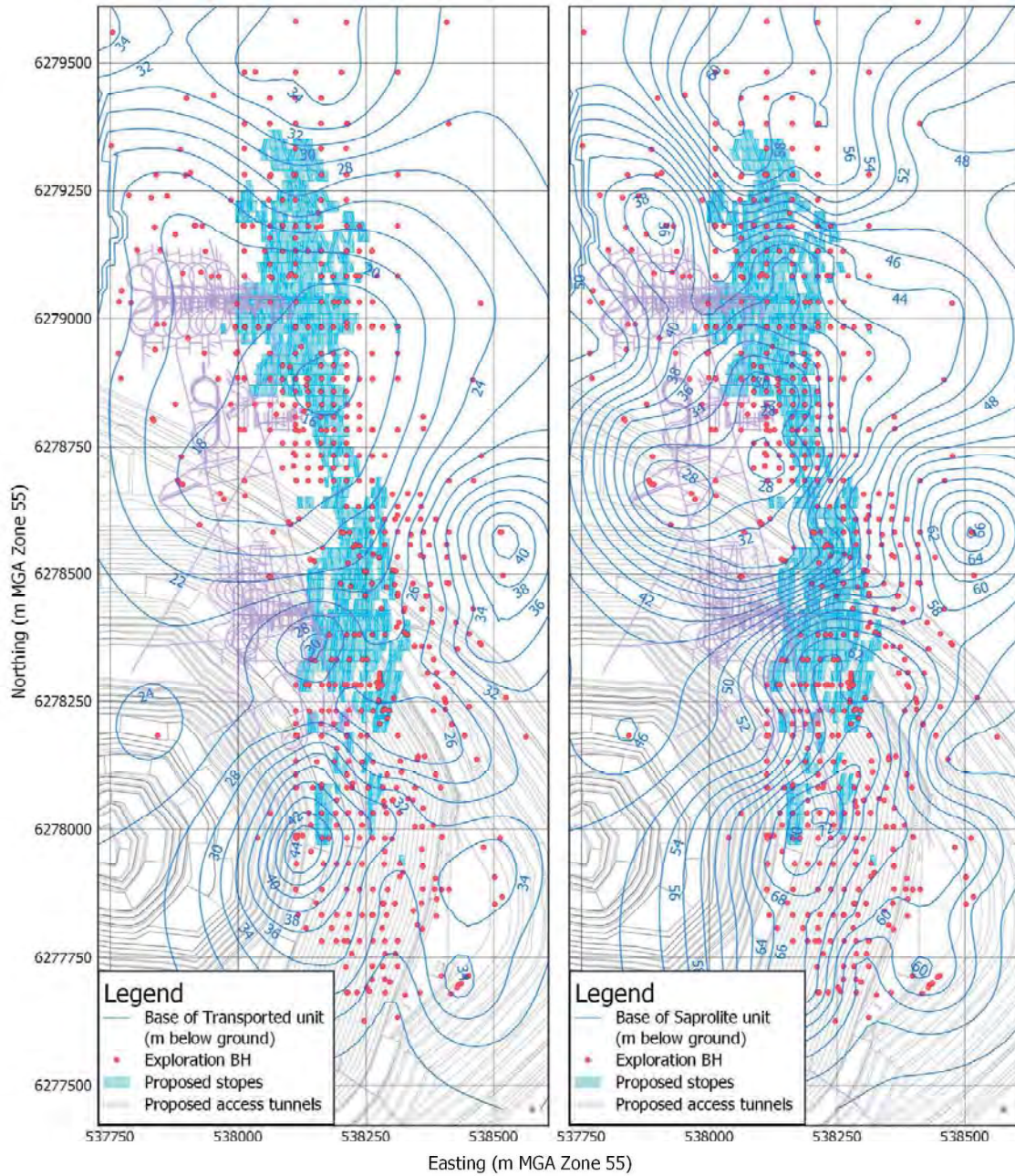

Figure 6-5: Depth to the base of Transported and Saprolite units as interpreted from exploration boreholes

Section CC' shown in Figure 6-6 was produced using the exploration borehole data and the proposed underground mine plan. As shown on the section, the exploration borehole data shows that the four hydrogeological units are continuous in a north south direction over the proposed mine. Note that the stopes are to be constructed entirely in the Primary Rock unit.

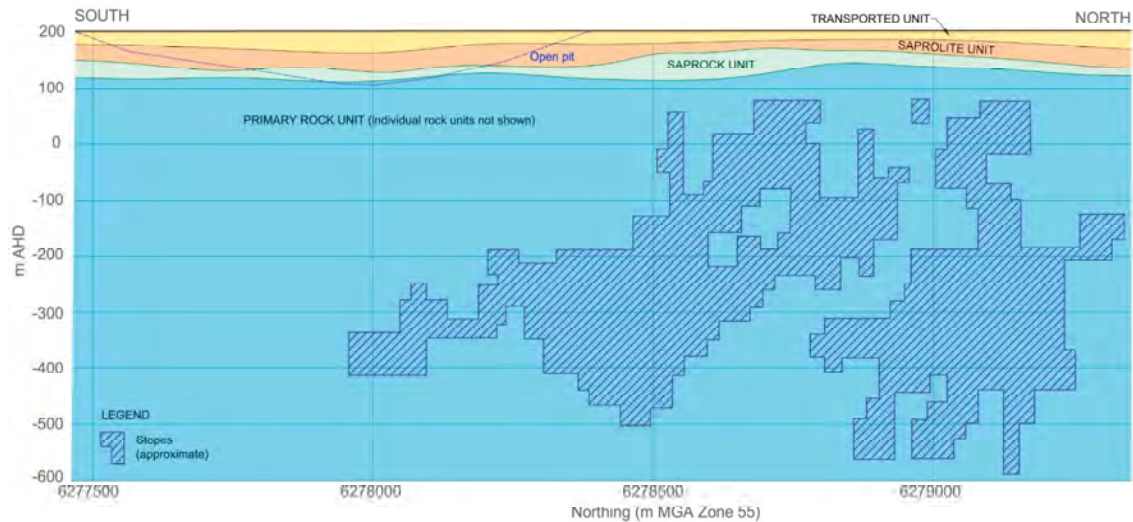

Figure 6-6: Section CC' showing hydrogeological unit elevations interpreted from exploration boreholes

6.3.1.1 Faults and structure

The mine geological model provided by Evolution Mining includes several faults, namely the Central, Cowal, Glenfiddich, Wilga and Wyrra faults, and a number of smaller faults. The five major faults all strike approximately north-south, with the Wilga deviating the most from this direction, striking NNE. In addition, the structural contacts between geological units around the mine site strike generally north-south with some localised north west or north east deviations, refer to Figure 5-3 and Figure 5-4.

The faults around the mine site are all non-active and thus unlikely to provide higher conductive pathways for water (Zoback, 2007). The zones surrounding the faults, however, may consist of more fractured rock and may have a higher conductivity. Observation of the exposed Glenfiddich Fault by a Coffey Engineer in the Exploration Decline Tunnel, close the entrance from the open pit in May 2019, showed minor groundwater inflow to the tunnel to be occurring at one side of the fault with little inflow elsewhere along a 150m section of tunnel near its intersection with the fault. The centre of the fault was clay filled.

The Glenfiddich fault was also observed to cross the exploration decline near its southern portal by a Coffey Field Engineer during a field investigation program between January and March 2020. The field investigation report is included as Appendix E. The Glenfiddich fault zone consisted of slightly more fractured rock compared to the surrounding rock over a zone of approximately 8 m width. Some areas of higher inflow were found adjacent to the fault. It is relevant to note, however, that many other areas of higher inflow were found in joints not apparently associated with the Glenfiddich fault or other faults. The widespread and intersecting nature of jointing and faulting observed inside the decline makes it impractical to describe the effect of individual faults on the groundwater flow regime without significant field testing and monitoring at and around the faults.

It does not appear that the Glenfiddich fault is providing a significant preferential conduit for groundwater when it is considered amongst the surrounding fractured rock at the scale of the CGO Underground Development.

6.4 Gravity survey

In April 2019, a detailed geophysical gravity survey commissioned by Evolution Mining was carried out by Haines Surveys Pty Ltd (Haines) and presented in a report (Haines Surveys, 2019).

The gravity survey data was provided to Coffey for further analysis and modelling which was carried out in November 2019. The proprietary software program Potent was used. Potent is a Windows-based application in an interactive framework for 3D modelling of potential field data (i.e. gravity and/or magnetics).

The interpretation of the data was calibrated to exploration borehole data, from which the thickness of the Transported unit had been observed directly. The majority of boreholes were clustered over the edge of the central eastern part of the survey area above the proposed underground mine. However, four boreholes were obtained from the NGIS public borehole database. These boreholes provide lithology logs showing the base of the Transported unit. The boreholes are GW703223, GW703225, GW704031 and GW704252. Their locations are shown in Figure 6-7.

The exploration and publicly available boreholes provide a reasonable constraint of the interpretation out to approximately 3 km east of the open pit. The interpreted thickness the Transported unit from the gravity survey data is shown in Figure 6-7. The figure shows that the Transported unit has a thickness ranging between approximately 30 m and 50 m in the area east of the open pit.

The gravity survey interpretation for areas outside those shown on Figure 6-7 did not converge in the analysis and so these areas were excluded from the interpretation.

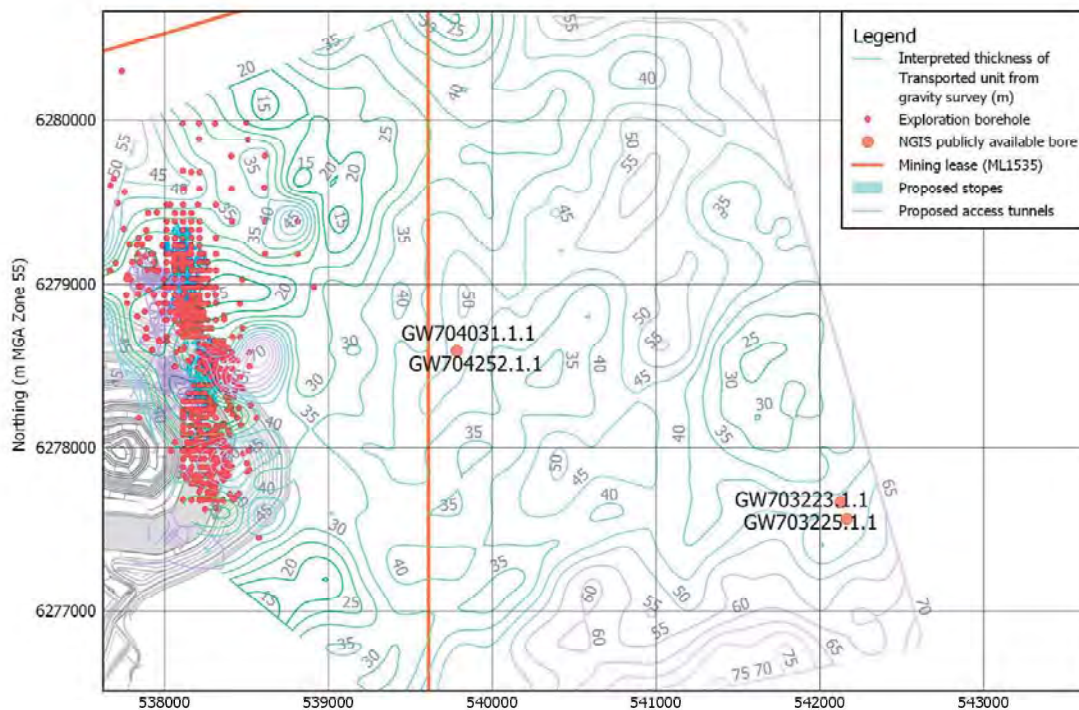

Figure 6-7: Thickness of the Transported unit from gravity survey interpretation

6.5 Regional groundwater levels and flow regimes

Regional groundwater levels are discussed in a companion report on the modelling of the Bland Creek Palaeochannel Borefield (Coffey, 2020c).

The groundwater conditions near the CGO open pit are controlled by local factors, such as the tailings storage facilities and open pit, rather than the groundwater conditions in the Bland Creek Palaeochannel aquifer system.

6.6 Local groundwater levels and flow regimes

6.6.1 Groundwater level monitoring

There are 37 piezometers currently monitoring groundwater levels within ML1535. The coordinates and screen elevations for these piezometers are shown in Table 6-1. The piezometers at PZ13 were re-activated in late August 2019.

12 additional piezometers were installed as part of field investigations in February 2020 at four boreholes to the north of the open pit near the proposed underground mine. These are described in the field investigation report which is included as Appendix E. Their coordinates and elevations are shown in Table 6-2.

The locations of the monitoring wells and piezometers are shown in Figure 6-8.

Table 6-1: Monitoring well details

Area	Well name	Screened unit	Easting (m MGA Zone 55)	Northing (m MGA Zone 55)	Top of casing (m AHD)	Top of screen (m below ground)	Base of screen (m below ground)
Pit Area	PDB1A	Saprock	537281.2	6279032.6	208.3	82.0	88.0
	PDB1B	Transported	537283.3	6279030.7	208.2	14.0	20.0
	PDB3A	Saprock	538502.1	6277855.0	204.8	94.5	100.5
	PDB3B	Transported	538507.2	6277854.6	204.8	23.6	29.6
	PDB5A	Saprock	537769.9	6276932.6	209.1	76.5	82.5
	PDB5B	Saprolite	537774.8	6276931.8	208.8	23.8	29.8
	PZ13VWP1	Primary Rock	538342.3	6278585.0	203.8	120 (VWP depth)	N/A
	PZ13VWP2	Saprock	538342.3	6278585.0	203.8	75 (VWP depth)	N/A
	PZ13VWP3	Saprock	538342.3	6278585.0	203.8	60 (VWP depth)	N/A
	PZ13VWP4	Saprolite	538342.3	6278585.0	203.8	32 (VWP depth)	N/A
Processing Areas	PP01	Transported	536980.7	6277623.0	215.6	13.0	25.0
	PP02	Transported	537009.3	6277527.7	213.0	8.5	18.5
	PP03	Saprolite	536986.5	6277451.1	213.5	31.0	51.0
	PP04	Transported	536894.8	6277292.4	213.9	10.5	19.5
	PP06	Transported	536777.5	6277585.8	214.0	11.0	20.0
	P555A	Saprolite	533112.4	6276760.3	227.4	17.8	19.8

Area	Well name	Screened unit	Easting (m MGA Zone 55)	Northing (m MGA Zone 55)	Top of casing (m AHD)	Top of screen (m below ground)	Base of screen (m below ground)
Tailings Areas	P555A-R	Saprock	533112.4	6276760.3	227.4	27.0	36.0
	P555B	Saprolite	533112.4	6276760.3	227.4	8.0	10.0
	P558A-R	Saprolite	532889.6	6277989.6	224.3	30.6	42.6
	P412A	Saprolite	535170.8	6277494.9	216.2	18.0	30.0
	P412A-R	Saprolite	535171.7	6277491.0	216.1	55.0	61.0
	P412B	Transported	535175.0	6277495.0	216.1	10.0	16.0
	P414A	Saprolite	535363.8	6276681.2	217.1	22.0	34.0
	P414B	Transported	535360.3	6276679.6	217.1	10.0	16.0
	P417A	Saprolite	535889.3	6276337.6	216.5	24.0	36.0
	P417B	Transported	535888.9	6276333.1	216.5	8.0	14.0
	P418A	Saprolite	534862.4	6279181.3	214.2	20.0	32.0
	P418B	Transported	534859.6	6279182.0	214.2	10.0	16.0
	TSFNA	Saprock	535438.0	6278073.9	215.3	92.0	98.0
	TSFNB	Transported	535442.6	6278072.8	215.2	24.1	30.1
	TSFNC	Transported	535447.5	6278071.7	215.3	12.0	18.0
	MON01A	Saprock	535111.7	6278223.5	215.3	63.0	69.0
	MON01B	Transported	535114.5	6278225.1	215.3	9.0	15.0
	MON02A	Saprock	534275.0	6276083.8	222.5	63.0	69.0
	MON02B	Saprolite	534277.1	6276085.9	222.4	24.0	30.0
	P561A	Saprolite	534603.0	6279313.0	215.1	21.0	23.0
P561B	Transported	534603.0	6279313.0	215.1	8.0	10.0	

Table 6-2: Piezometers installed in February 2020

Area	Piezometer name	Screened unit	Easting (m MGA Zone 55)	Northing (m MGA Zone 55)	Sensor elevation (m AHD)
Stopes Area	UG-BH-01 (SG1)	Transported	537751.6	6278843.8	189.1
	UG-BH-01 (SG2)	Transported	537751.6	6278843.8	174.1
	UG-BH-01 (SG3)	Saprock	537751.6	6278843.8	134.1
	UG-BH-02 (SG1)	Transported	538180.0	6279593.8	190.8
	UG-BH-02 (SG2)	Saprolite	538180.0	6279593.8	160.8
	UG-BH-02 (SG3)	Primary Rock	538180.0	6279593.8	103.8
	UG-BH-03 (SG1)	Transported	538019.1	6278883.0	188.9
	UG-BH-03 (SG2)	Saprolite	538019.1	6278883.0	173.9
	UG-BH-03 (SG3)	Primary Rock	538019.1	6278883.0	133.9
	UG-BH-04 (SG1)	Transported	538169.0	6278916.0	188.8
	UG-BH-04 (SG2)	Saprock	538169.0	6278916.0	158.8
	UG-BH-04 (SG3)	Primary Rock	538169.0	6278916.0	102.3

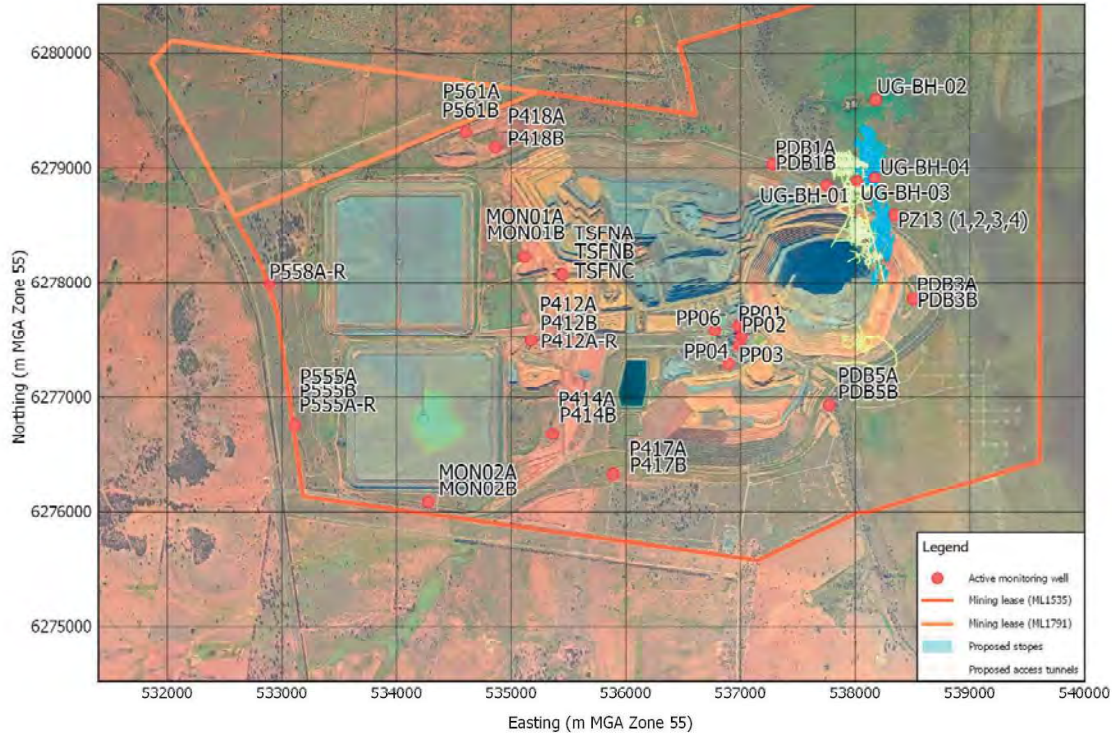

Figure 6-8: Monitoring well locations (Aerial imagery provided by Evolution Mining, December 2019)

6.7 Groundwater levels and flow regimes within ML1535

Over the life of the CGO, Lake Cowal remained dry until June 2010, when significant rainfall caused the lake to begin to fill with water. By late 2014 the lake was again dry due to evaporation. The lake began to fill with water from the significant rainfall events in June to September 2016; the peak water level recorded being 207.49 m AHD in October 2016. At the peak, water overflowed to Nerang Cowal. The lake water level dropped rapidly to its full level, controlled by overflow to Nerang Cowal, with the gradual decline in water level continuing to February 2019 when the lake became dry. The lake has remained dry from then until the time of writing in June 2020.

Since the commencement of the CGO, the underlying aquifers surrounding and intercepting the open pit have been depressurised as a result of inflows to the open pit and active pit dewatering (discussed further in Section 7.2). Despite Lake Cowal becoming inundated, groundwater inflows to the open pit are assessed to have remained below or consistent with historical records and are relatively stable. This is likely because the lacustrine sediments that form the lakebed have a very low vertical permeability and act as a low permeability layer between the lake water and underlying aquifers (Coffey, 1997). The results of groundwater model calibration, discussed in Section 8.2, support this understanding.

The open pit groundwater inflow observations confirm the finding of Coffey (1997) that the long-term leakage from the lake (when containing water) to underlying aquifers would be very small and not assessable.

It is relevant to note that the groundwater level in piezometer PDB3A fell significantly in March 2011. This corresponds to the date of installation of horizontal drains W911 (passing within 30 m of PDB3A) and W912 (passing within 110 m of PDB3A), both of which reported significant groundwater flows immediately following installation (600 m³/day and 170 m³/day, respectively). It is likely that the

groundwater level in piezometer PDB3A has been significantly influenced by pit dewatering since March 2011.

Figure 6-9 shows groundwater head contours in the Transported and Saprolite units taken in December 2019. This figure shows that, in the area between the TSFs and the open pit, groundwater flows eastwards from the TSFs toward the open pit. Groundwater levels over time are presented in Appendix C.

6.7.1 Groundwater Response to tailings storage facilities

Groundwater monitoring records for piezometers in the vicinity of the TSFs are shown in Figure A2 (Appendix A).

Groundwater levels in the Transported, Saprolite and Saprock units in the vicinity of the TSFs show a progressive rise since the CGO began operating. Generally, the magnitude of the groundwater rise correlates with the distance of the monitoring bore from the TSFs. For example, in the Transported unit, the groundwater level rise at P414B, which is relatively close to the TSFs, is greater than that at TSFNB, located further away. Similarly, in the Saprock unit, MON02A has displayed a significant rise since late 2006, whilst the magnitude of groundwater level rise at MON01A (located further from the TSFs) is lower.

Groundwater levels at MON02A and MON02B (screened in the Saprock and Saprolite units, respectively) have displayed a significant rise since late 2006. Groundwater level variation around the TSFs was investigated by Coffey (2009a). Rises were assessed to be related to the percolation and the movement of seepage from the TSFs.

Note that modelling carried out for the Cowal Gold Project Environmental Impact Statement (EIS) (North Limited, 1998) predicted a groundwater level rise around the tailings impoundments to near the ground surface under some assumptions, in relation to hydraulic properties of the soil profile and tailings dam materials (Appendix N – Attachment N2-A of the EIS). The results at MON02A and MON02B are consistent with this possibility. Well-established measures can be used to control groundwater levels approaching the surface should this prove necessary. Possible methods for shallow groundwater control include the use of drainage trenches.

6.7.2 Surface Water Bodies

Records of Lake Cowal water levels available from August 1990 to November 2001 indicated levels varied between 202.9 m AHD and 206.2 m AHD over this period. Hawkes (1998) reported that the full storage Lake Cowal water level was 205.65 m AHD. North Limited (1998) reported that the full storage Lake Cowal water level was 205.7 m AHD and the bed level was 201.5 m AHD.

Following filling of Lake Cowal, the water level measurement records show that over a 12 month period from May 2012, water level fell at an average rate of between 3 mm and 4 mm per day.

Assuming the lake water is lost to evaporation and considering the annual pan evaporation rate of 1,971 mm, this rate of decline in lake water levels is equivalent to a pan evaporation factor of 0.8 (i.e. an annual open water evaporation rate of 1,577 mm), a factor within the range of expected values for a lake in this regional setting.

When Lake Cowal is full, it overflows into Nerang Cowal (North Limited, 1998). Data was not available for historical water levels within Nerang Cowal during wet periods, with the exception that, as of August 2010, it was reported by CGO staff that the water within Lake Cowal had not overflowed into Nerang Cowal. Nerang Cowal is likely to have been dry from 2005 (and possibly earlier) until a flood event in March 2012. Satellite imagery shows that Nerang Cowal also contained water in mid-2016. Nerang Cowal (along with Lake Cowal) flooded in October 2016.

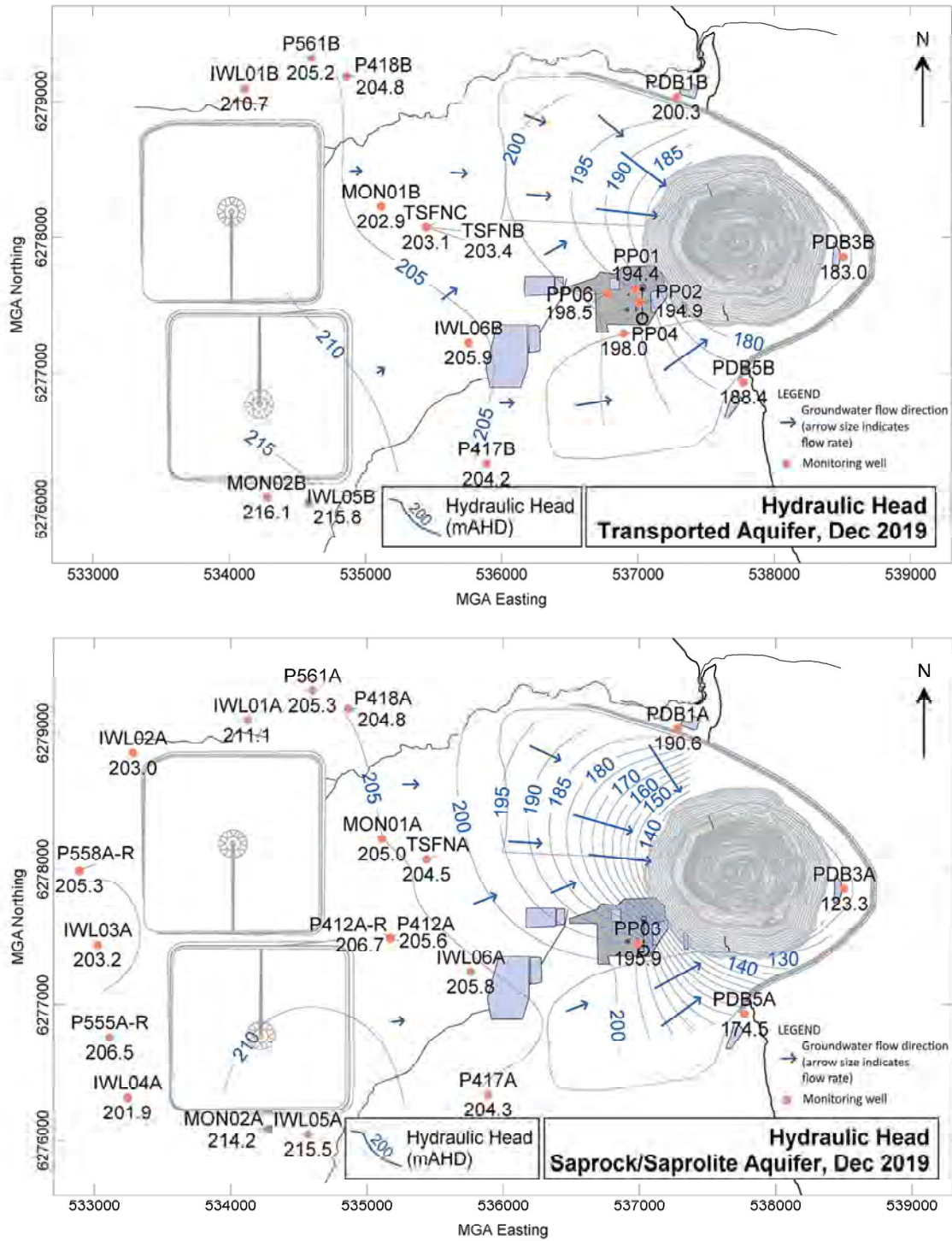

Figure 6-9: Observed hydraulic head in December 2019 for the Transported and Saprolite units (Coffey, 2020b)

6.7.3 Groundwater Quality

6.7.3.1 Groundwater quality in ML1535

Electrical Conductivity (EC) concentrations and pH levels in groundwater within ML1535 have generally remained stable between 2004 and 2020. Monitored pH levels have been slightly acidic to neutral and have been similar to baseline levels. Monitored pH levels close to the TSFs have generally ranged between 6.5 and 7, with the exception of MON01B (to the east of the northern TSF), with a lower pH generally ranging between 4.5 and 7, TSFNC with a pH of around 6, and PP03 and CB01 with a pH of around 8. While open pit dewatering is causing a localised reduction in groundwater levels, pH and EC appear to be unaffected by this drawdown.

6.7.3.2 Groundwater contamination in ML1535

6.7.3.3 Cyanide is used in the gold extraction process and is measured by Evolution as both total cyanide and weak acid dissociable (WAD) cyanide. The default guideline value (DGV) of 0.007 mg/L is for non-ionised hydrogen cyanide (HCN) which may be converted to free cyanide (HCN+CN⁻) using the ANZECC Table 8.3.8 and corresponding pH and temperature values (ANZECC, 2000). The total cyanide is free cyanide plus the measurable cyanide from breakdown of metallo-cyanide and organic complexes. The LOR for cyanide is 0.004 mg/L.

Monitoring results for cyanide in groundwater were reviewed for the mine life history (September 2004 to Jan 2020). Within the available data, concentrations over this period have remained below the Limit of Reporting concentration of 0.004 mg/L at all monitoring locations, with the exception of those listed in Table 6-3.

Generally, cyanide has not been observed at significant concentrations in groundwater over the site. Where monitoring has shown total cyanide to be present, its concentration at individual monitoring locations has not been consistent over time, and its observed presence has not always been supported by WAD analysis.

The groundwater monitoring results suggest that, as of January 2020, there is no consistent trend to suggest that significant concentrations of cyanide have leached from the TSFs into the surrounding groundwater.

Table 6-3: Cyanide detections

Year	Month	Bore	Total Cyanide Concentration (mg/L)	WAD Cyanide Concentration (mg/L)
2005	February	P417B	0.006	<0.005
	August	P417B	0.009	<0.005
2006	August	MON01A	0.004	<0.004
2007	September	MON01B	0.084	0.041
2008	March	P417B	0.008	<0.004
	August	PDB3A	0.007	0.006
		PDB4A	0.109	0.040
2009	September	PP01	0.030	0.030
		PP05	0.072	0.040

Year	Month	Bore	Total Cyanide Concentration (mg/L)	WAD Cyanide Concentration (mg/L)
2010	February	MON01B	0.014	<0.004
		P414B	0.006	<0.004
		P417B	0.007	<0.004
2011	September	PP02	0.004	0.004
	November	MON01A	0.045	0.004
2012	February	TSFNC	0.017	<0.004
	March	PP02	0.016	<0.004
	May	P417B	0.010	<0.004
		PP05	0.017	<0.004
		PP06	0.042	0.017
	October	TSFNA	0.009	<0.004
		TSFNB	0.009	<0.004
		TSFNC	0.010	<0.004
		P418A	0.015	<0.004
		P418B	0.027	0.008
P558A-R		0.006	<0.004	
P417A	0.005	<0.004		
2013	April	MON02A	0.017	<0.004
		P412A-R	0.027	<0.004
		P417A	0.034	<0.004
		P417B	0.005	<0.004
2014	No detections above laboratory limit of reporting			
2015	September	MON01B	0.012	0.007
		P414B	0.017	0.010
		P417B	0.025	0.016
2016	No detections above laboratory limit of reporting			
2017	No detections above laboratory limit of reporting			
2018	No detections above laboratory limit of reporting			
2019	15 October	TSFNB	0.252	<0.004
		TSFNC	0.027	0.02
	25 October	No detections above laboratory limit of reporting		

6.8 Aquifer Parameters

Coffey (2006) reviewed hydraulic testing data conducted in pumping bores and observation piezometers screened within the Lachlan and Cowra Formations within the Bland Creek Paleochannel Borefield (formerly known as the Jemalong Borefield Area), located to the north-east of the mine site. Transmissivities averaged 35 square metres per day (m^2/day) within the Upper Cowra Formation (up to 50 m depth) and $8 \text{ m}^2/\text{day}$ within the Lower Cowra Formation (average depth 50 m to 90 m). Interpreted horizontal hydraulic conductivities, converted from transmissivity values using the total screened interval of the borehole, typically ranged from 0.1 to 10 metres per day (m/day).

The adopted parameter values for the calibrated model used in a previous pit dewatering assessment (Coffey, 2008) are shown in Table 6-4.

Table 6-4: Adopted model parameters (Coffey, 2008)

Hydrogeological Unit	Geological Unit	Horizontal Hydraulic Conductivity (m/day)	Vertical Hydraulic Conductivity (m/day)	Specific Yield
Transported	Cowra Formation	1.0×10^{-3}	1.0×10^{-4}	0.15
Saprolite	Lake Cowal Volcanics	5.0×10^{-2}	5.0×10^{-2}	0.02
Saprock	Ordovician Host Rock	1.0×10^{-2}	1.0×10^{-2}	0.02
Primary Rock	Ordovician Host Rock	1.0×10^{-2}	1.0×10^{-2}	0.02

Source: Coffey (2008)

A calibrated groundwater model developed by Coffey (2009a) to assess groundwater level changes at the mine site adopted the parameter values shown in Table 6-5.

Table 6-5: Adopted Model Parameters (Coffey, 2009a)

Hydrogeological unit	Geological unit	Horizontal Hydraulic Conductivity (m/day)	Vertical Hydraulic Conductivity (m/day)	Specific Yield
Transported	Cowra Formation	1.0×10^{-2}	3.0×10^{-3}	0.05
Saprolite	Lake Cowal Volcanics	1.0×10^{-1}	1.0×10^{-2}	0.002
Saprock	Ordovician Host Rock	1.0×10^{-2}	1.0×10^{-3}	0.02

Source: Coffey (2009a)

A recovery test conducted in monitoring bore PD3 (a bore located in the north west quadrant of the pit and subsequently destroyed by mining), screened over the Transported and Saprolite units, suggested those units possessed a collective transmissivity of $1.2 \text{ m}^2/\text{day}$ (Coffey, 2008). In consideration of the 90.5 m total screen interval of PD3, the estimated horizontal hydraulic conductivities over both the Transported and Saprolite units were estimated at $0.01 \text{ m}/\text{day}$.

Coffey (2009a) collated falling head permeability test data from piezometers located both within and to the east of the TSF area. Results yielded the following hydraulic conductivity values:

- An arithmetic mean of 0.02 m/day and a geometric mean of 0.01 m/day for the Transported at 6 to 16 m below ground surface; and
- An arithmetic mean of 0.05 m/day and a geometric mean of 0.02 m/day for the Saprolite at 18 to 36 m below ground surface.

These values are relatively consistent with the PD3 recovery test result noted above and the values adopted in the calibrated pit dewatering assessment model (Coffey, 2008), as shown in Table 4.

No hydraulic test data were available from which an assessment of the specific yield of the Cowra Formation could be made. Numerical modelling conducted by Williams (1993) assumed a value of 5% for the pore volume available for increased storage at the water table in the Upper Cowra Formation in the Jemalong Plains Irrigation District. Based on lithology and literature (Johnson, 1967) a specific yield of 4% was adopted for groundwater supply modelling (Coffey, 2006).

Coffey analysed results from pumping tests undertaken in the dewatering bores in 2004. Bores were screened over the full sequence of Transported, Saprolite and Saprock units. This introduces some uncertainty as flow components attributable to individual aquifer horizons are unknown. The horizons are somewhat gradational and precise boundaries are difficult to identify. The average hydraulic conductivity from the analysed data was 0.06 m/day.

Based on pumping test, recovery test and slug test data (Coffey, 1995a), Hawkes (1998) adopted the model parameters shown in Table 6-6 for a pit dewatering model. It should be noted that the model developed by Hawkes (1998) considered alternating aquifer and aquitard model layers throughout (i.e. contrastingly high and low hydraulic conductivity units alternated with depth) and divided the Transported unit into two aquifers (relatively high hydraulic conductivity units) and two aquitards (relatively low hydraulic conductivity units). Data was sufficient for this approach in modelling the pit area alone.

A calibrated groundwater model developed by NOW (now the Department of Primary Industries – Crown Lands and Water [CL&W]) (Bilge, 2012) for the Upper Lachlan catchment adopted horizontal hydraulic conductivities generally ranging from less than 1 to 20 m/day in the Lower Cowra Formation and from less than 1 to 35 m/day in the Upper Cowra Formation over the present model domain.

Table 6-6. Adopted Model Parameters (Hawkes, 1998)

Hydrogeological Unit	Geological Unit	Horizontal Hydraulic Conductivity (m/day)	Vertical Hydraulic Conductivity (m/day)	Specific Yield	Confined Storage Coefficient
Transported	Cowra Formation	2.0×10 ⁰ to 3.0×10 ⁰	1.0×10 ⁻⁴	1.0×10 ⁻³	1.5×10 ⁻¹
Saprolite	Lake Cowal Volcanics	-	1.0×10 ⁻⁴	-	-
Saprock	Ordovician Host Rock	1.5×10 ⁰	-	1.0×10 ⁻²	1.0×10 ⁻³
Primary Rock	Ordovician Host Rock	-	1.0×10 ⁻⁴	-	-

Source: Hawkes (1998)

Analysis of pumping tests conducted in 2004 in bores of the Bland Creek Paleochannel Borefields, located to the north-east of the mine site area, provide several values of confined storativity, giving an average storativity of 1.9×10⁻⁴ for the Lachlan Formation (Groundwater Consulting Services Pty Ltd [GCS], 2006), or an average specific storage of 9.5×10⁻⁶ m⁻¹, assuming a 20 m thick aquifer. A pumping test of seven days duration conducted at BLPR2 (located approximately 18 km to the north-north east of pit E42) gave an average storativity of 1.7×10⁻⁴ for the Lachlan Formation, or an average specific storage of 8.5×10⁻⁶ m⁻¹, assuming a 20 m thick aquifer. The lower permeability sediments that occur further away from the deeper parts of the palaeochannel appear to possess

similar hydraulic properties to the Lower Cowra Formation (Coffey, 2006). However, in practical terms, a portion of the assessed storativities will be influenced by vertical leakage from the base of the Lower Cowra Formation during pumping tests.

A calibrated groundwater model developed by NOW (now the NSW Department of Industry - Water) (Bilge, 2012) for the Upper Lachlan catchment adopted specific yield values generally ranging from 0.06 to 0.25 in the Upper Cowra Formation. Storage coefficients in the same model generally ranged from 5.5×10^{-6} to 1.7×10^{-5} in the Lower Cowra Formation.

GCS (2008) co-ordinated a pumping test in the Transported materials (Cowra Formation). The testing was conducted to assess the potential yield of the Saline Supply Borefield, located within the ML1535. Test results suggest a hydraulic conductivity of the Transported material of approximately 5 m/day and a specific yield of approximately 1.6×10^{-3} .

A calibrated groundwater model used for the MOD14 assessment (Coffey, 2018a) adopted horizontal and vertical hydraulic conductivities of the Transported materials of 1.0×10^{-2} m/d and 6.5×10^{-4} m/d respectively.

A summary of various values of groundwater parameters adopted for previous work is presented in Table 6-7 and Table 6-8.

Coffey (1995a) noted that there was little apparent difference in transmissivity between the major structural features (fractured dykes) within the pit area and relatively fresh bedrock. Therefore, aquifer parameters are expected to be similar for bedrock and geological fault features. The bedrock consists mostly of sedimentary sequences and is considered to have significantly lower permeability than unconsolidated sediments, except in structurally disturbed areas.

6.8.1.1 Tailings storage facilities

Based on test drilling data, geophysical studies and piezometer installations around the proposed TSF reported by North Limited (1998):

- The foundation of the existing TSF comprises silty clay with some gravelly clay, and highly weathered rock occurring at shallow depth in the west. The thickness of unconsolidated sediments decreases from east to west.
- The groundwater movement through the tailings areas prior to mine development was essentially from west to east with a hydraulic gradient of about 7×10^{-3} m.
- Field permeability testing of strata expected to be of higher permeability indicate low horizontal permeability of the order of 2×10^{-4} to 1×10^{-3} m/day for gravelly clay and 0.6×10^{-4} to 3.5×10^{-4} m/day for weathered rock.
- Laboratory infiltration tests indicate vertical permeability of the less permeable soils of the order of 0.9×10^{-6} to 1.3×10^{-6} m/day.

Table 6-7. Summary of horizontal hydraulic conductivity values adopted for previous work

Hydrogeological Unit (Geological Unit)	Value (m/day)	Region	Source	Reference
Transported (Cowra Formation)	1×10^{-1} to 1×10^2	Jemalong Borefield	Hydraulic testing	Coffey (2006)
	5	Saline Supply Borefield, ML1535	Pumping test	GCS (2008)
	1×10^{-2}	TSF	Slug test	Coffey (2009a)
	1×10^{-2}	Mine Site	Modelling	Coffey (2009a)

Hydrogeological Unit (Geological Unit)	Value (m/day)	Region	Source	Reference
	1×10^{-3}	E42 open Pit	Modelling	Coffey (2008)
	2 to 3	E42 open Pit	Modelling	Hawkes (1998)
	1 to 35	Upper Lachlan catchment	Modelling	Bilge (2012)
	1 to 2	Jemalong	Regional Modelling	Coffey (2011)
	1	Elsewhere		
	1×10^{-2} (horizontal)	Mine Site	Modelling	Coffey (2018a)
	6.5×10^{-4} (vertical)	Mine Site	Modelling	Coffey (2018a)
Transported (Cowra Formation) and Saprolite	1×10^{-2}	E42 open Pit	Recovery test	Coffey (2008)
Transported (Cowra Formation), Saprolite and Saprock (Ordovician Host Rock)	6×10^{-2}	E42 open Pit	Pumping test	Coffey (1995a)
Saprolite	2×10^{-2}	TSF	Slug testing	Coffey (2009a)
	1×10^{-1}	Mine Site	Modelling	Coffey (2009a)
	5×10^{-2}	E42 open Pit	Modelling	Coffey (2008)
	2×10^{-2}	Mine Site	Modelling	Coffey (2018a)
Saprock (Ordovician Host Rock)	1×10^{-2}	Mine Site	Modelling	Coffey (2009a)
	1×10^{-2}	E42 open Pit	Modelling	Coffey (2008)
	1.5	E42 open Pit	Modelling	Hawkes (1998)
	2×10^{-3}	Mine Site	Modelling	Coffey (2018a)
Primary Rock (Ordovician Host Rock)	1×10^{-2}	E42 open Pit	Modelling	Coffey (2008)
Lachlan Formation	3×10^{-2} to 1×10^2	Jemalong Borefield	Hydraulic testing	Coffey (2006)
	3 to 28	Regionally	Regional Modelling	Coffey (2011)

Table 6-8. Summary of specific yield and storage values adopted for previous work

Unit(s)	Specific Yield	Storage Coefficient	Region	Source	Reference
Transported (Cowra Formation)	1.0×10^{-3}	1.5×10^{-1}	E42 open Pit	See text	Hawkes (1998)
	1.5×10^{-1}	-	E42 open Pit	Modelling	Coffey (2008)
	5.0×10^{-2}	-	Mine Site	Modelling	Coffey (2009a)
	6.0×10^{-2} to 3.0×10^{-1}	5.5×10^{-6} to 1.7×10^{-5}	Upper Lachlan catchment	Modelling	Bilge (2012)

Unit(s)	Specific Yield	Storage Coefficient	Region	Source	Reference
	1.6×10^{-3}	-	Saline Supply Borefield, Mine Lease	Pumping test	GCS (2008)
	4.0×10^{-2}	1.5×10^{-5}	Regionally	Regional Modelling	Coffey (2011)
	1.5×10^{-1}	5×10^{-4}	Mine Site	Modelling	Coffey (2018a)
Saprolite	2.0×10^{-2}	-	E42 open Pit	Modelling	Coffey (2008)
	2.0×10^{-3}	-	Mine Site	Modelling	Coffey (2009a)
	1.0×10^{-4}	5×10^{-5}	Mine Site	Modelling	Coffey (2018a)
Saprock (Ordovician Host Rock)	1.0×10^{-2}	1.0×10^{-3}	E42 open Pit	See text	Hawkes (1998)
	2.0×10^{-2}	-	E42 open Pit	Modelling	Coffey (2008)
	2.0×10^{-2}	-	Mine Site	Modelling	Coffey (2009a)
	1.0×10^{-4}	3×10^{-5}	Mine Site	Modelling	Coffey (2018a)
Primary Rock (Ordovician Host Rock)	2.0×10^{-2}	-	E42 open Pit	Modelling	Coffey (2008)
Lachlan Formation	1.9×10^{-4}	-	Jemalong Borefield	Pumping test	GCS (2006)
	1.7×10^{-4}	-	Jemalong Borefield	Pumping test	Coffey (1995c)
	N/A	1.5×10^{-5}	Regionally	Regional Modelling	Coffey (2011)

URS Australia Pty Limited (URS) (2005, 2006) conducted field investigations and laboratory testing for both the northern and southern TSFs, concluding that:

- Investigations consistently showed the uppermost 5 m of the TSF footprints to be essentially clay soils of extremely low permeability.
- Laboratory testing of typical samples from within 5 m of floor level yielded permeabilities less than the target permeability of 1×10^{-9} m/s (9×10^{-5} m/day).
- Inspections of cut-off trench excavation and storage floor did not reveal any significant extensive or continuous zones or lenses of high permeability soil that might provide a leakage path.

Surface infiltration tests carried out by site personnel in shallow test pits to the east of the TSF area (Coffey, 1995c) indicated a low infiltration permeability range from 8×10^{-4} m/day to 3×10^{-5} m/day, with an arithmetic mean of 2×10^{-4} m/day and a geometric mean of 1×10^{-4} m/day.

Falling head permeability tests and consolidation tests were conducted by Knight Piesold Pty Ltd (1994) on saturated tailings samples with unrestricted drainage from the base. Results are shown in Table 6-9 and indicate the reported permeability of saturated tailings (prior to additional consolidation due to tailings loading or air drying).

The conditions encountered for the floor of the existing TSF are anticipated to apply to the floor of the IWL which is currently being developed as part of the approved Modification 14.

Table 6-9. Tailings Permeability Data (Knight Piesold Pty Ltd, 1994)

Test Type	Sample	Permeability (m/d)	Dry Density (tonnes/m ³)
Falling Head Permeability Tests	Primary Tailings	0.02	1.29
		0.02	1.29
	Oxide Tailings	0.01	1.18
		0.01	1.2
Consolidation Tests	Primary Tailings	0.62	1.07
		0.09	1.1
		0.02	1.2
	Oxide Tailings	0.27	0.95
		0.03	0.99
		0.01	1.12
		0.01	1.13

Source: Knight Piesold Pty Ltd (1994)

A calibrated groundwater model developed by Coffey (2009a) to assess groundwater level changes associated with the TSFs adopted the parameter values shown in Table 6-10 for tailings materials.

Table 6-10. Adopted Model Parameters (Coffey, 2009a)

Unit	Horizontal Permeability (m/d)	Vertical Permeability (m/d)	Specific Yield
Deposited Tailings	5.0×10^{-2}	5.0×10^{-3}	0.01
TSF Embankment - Clay	1.0×10^{-4}	1.0×10^{-4}	0.15

Source: Coffey (2009a)

A summary of the above information is presented in Table 6-11.

Table 6-11. Summary of TSF parameters adopted for previous work

Hydrogeological Unit	Horizontal Permeability (m/d)	Vertical Permeability (m/d)	Specific Yield	Reference
TSF Foundation	1×10^{-3} to 6×10^{-5}	1.3×10^{-6} to 9×10^{-7}	N/A	North Limited (1998)
	N/A	8.6×10^{-5}	N/A	URS (2005, 2006)
	N/A	2×10^{-4}	N/A	Coffey (1995c)
Deposited Tailings	N/A	1×10^{-2} to 6.2×10^{-1}	N/A	Knight Piesold (1994)
	5.0×10^{-2}	5.0×10^{-3}	0.01	Coffey (2009a) (model)
	5.0×10^{-2}	5.0×10^{-4}	0.015	Coffey (2018a) (model)
TSF Embankment - Clay	1.0×10^{-4}	1.0×10^{-4}	0.15	Coffey (2009a and 2018a) (models)

6.8.1.2 Field investigations in 2020

To support assessment of groundwater level and hydraulic conductivity parameters adopted for the UG EIS, a field investigation program was carried out between 28 January and 29 February 2020, see Appendix E. Coffey field engineers attended the CGO mine site to supervise drilling and testing and to complete the piezometer installations associated with the field investigations.

Four vertical boreholes (UG-BH-01, UG-BH-02, UG-BH-03 and UG-BH-04) were drilled from the surface of Lake Cowal. Lake Cowal was dry during the fieldwork and at the time of writing this report (September 2020). Two boreholes were drilled to 70 m and two boreholes were drilled to 100 m depth. Borehole water pressure (packer) testing was carried out at locations nominated by Coffey on selected boreholes. The borehole locations are shown in Figure 6-8. A summary of the packer test results is shown in Table 6-12. Packer tests were not conducted at UG-BH-01 as a suitable section of non-fractured core to seat the packers was not identified.

Table 6-12: Packer test results on boreholes drilled in 2020

Borehole	Depth (m below ground)	Unit	Hydraulic conductivity (m/day)
UG-BH-02	97.0 – 103.0	Saprock	2.6×10^{-4}
UG-BH-03	60.0 – 64.0	Saprock	$< 1 \times 10^{-4}$
UG-BH-03	65.0 – 72.0	Saprock	$< 1 \times 10^{-4}$
UG-BH-04	54.0 – 59.0	Saprock	9.5×10^{-3}
UG-BH-04	63.0 – 68.0	Saprock	3.5×10^{-4}
UG-BH-04	72.0 – 77.0	Primary Rock	1.0×10^{-2}
UG-BH-04	91.0 – 102.0	Primary Rock	$< 1 \times 10^{-4}$

As part of the fieldwork, groundwater seepage into the GRE46 exploration decline was mapped by a Coffey field engineer. The total rate of groundwater inflow into the decline was assessed to be 2.8 L/s on 27 February 2020 based on site records. An assessment of the hydraulic conductivity required to produce this flow rate was carried out. This was done by assuming an equivalent length tunnel in uniform rock with the same approximate groundwater heads and tunnel elevation profile. The resulting hydraulic conductivity was assessed to be 4.8×10^{-4} m/day. This result is similar to the median of the packer testing results (2.6×10^{-4} m/day) shown in Table 6-12.

7 Representation of mining activities

7.1 Open pit excavation schedule

Open pit geometries were provided at intervals from December 2005 to June 2010, and for December 2011, June 2012, January 2013, January 2015, January 2018 and January 2020. The planned open pit geometry for 2020 to 2026 (end of open pit mining) was provided by Evolution Mining. Based on this data, Figure 7-1 shows the approximate elevation of the base of the open pit over time.



Figure 7-1: Approximate elevation of base of open pit over time

7.2 Open pit dewatering

A ring of vertical dewatering bores have historically operated to control groundwater levels around the pit. The vertical bore dewatering system was commissioned progressively, commencing in January 2005 to full operation by mid-2005. Records of dewatering volumes for the vertical bores for the period February 2005 to December 2009 indicate relatively consistent results after August 2005.

By 2012, all of the initial sets of bores had been decommissioned. Seven new dewatering bores were installed during 2011 as part of the Stage E pit cutback and began pumping groundwater in November 2011. These were gradually decommissioned with mine groundwater inflow being captured by horizontal drains or emerging from the face. In August 2017 only two vertical dewatering bores remained in use, and by the end of 2017 no vertical dewatering bores were in use.

In addition to the vertical dewatering bores (now all decommissioned), horizontal bores (drains) have been progressively installed, and some decommissioned, within the open pit since 2006. These horizontal bores continue to operate and have proven successful in controlling groundwater pressure behind the pit face.

Groundwater seepage into the open pit, groundwater flows from in-pit horizontal drains, and rainfall runoff in the pit are directed to pit sumps before being pumped to water storage dams.

CGO records the volumes pumped out of in-pit sumps and the volumes abstracted by the vertical dewatering bores on a monthly basis. The volume pumped out of in-pit sumps in any month is the sum of the volumes from the rainfall runoff, pit face seepage, and horizontal drains. Rainfall runoff may come from areas outside the pit footprint. Pit dewatering is discussed further in Section 8.2.9.

Based on modelling and interpretation of pit dewatering volumes, as discussed below in Section 8.2.9, groundwater inflow to the open pit is estimated to have gradually increased since 2008 and at January 2020 there is an estimated 1,000 m³ of groundwater inflow to the open pit per day. It is relevant to note that no increase in groundwater inflow to the open pit was observed during or following the 2010, 2012 and 2016 lake-fill events based on pit dewatering records.

7.3 Storage dams

Storage dams located within the CGO are shown in Figure 7-2. Note that D10 has not been constructed at the time of writing in September 2020. Historical water levels within the storage dams D1, D2, D3, D4, D5A, D6, D8B and D9 were reviewed. Dams D1, D2, D3, D4, D5A, D6 and D8B were small and located in a way such that their impact on groundwater levels is likely to be insignificant.

Available groundwater monitoring data (for example PP04, as shown in Appendix A - Figure A3) suggest that water seepage from D9 does not impact groundwater levels. Earlier model calibrations supported this assessment and D9 was not included within the model thereafter.

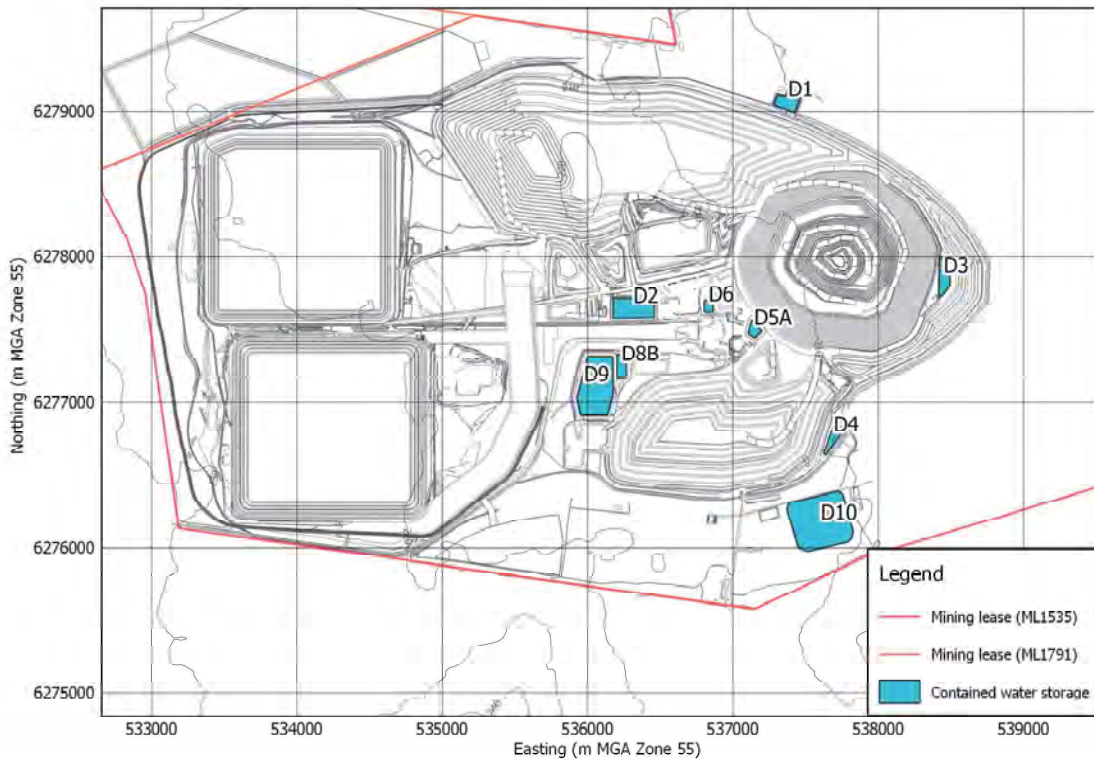

Figure 7-2: Storage dams

7.4 Tailings storage facilities and Integrated Waste Landform

Crest levels provided by Evolution Mining are shown in Table 7-1. The IWL (Integrated Waste Landform encompassing the existing tailings storage facilities (TSFs)) is planned to be operational from 1 January 2021.

Due to tailings solids deposition, the surface of deposited tailings rises over time within each TSF. The lowest elevation of the surface of deposited tailings within each dam was estimated based on the

nominated crest levels, known dam geometries, and assuming a tailings beach slope of 0.5%. Table 7-1 presents the estimated lowest deposited tailings surface elevation within each dam associated with each raise of the tailings embankment.

Historical tailings dam water levels were not available. However, historical percentage water coverage data for the tailings dams was provided for May 2006 to September 2010, and for March 2012 to November 2012. Based on the geometry of the TSFs, the maximum water depth within both the northern and southern TSFs, averaged over these periods, is estimated to be 0.2 m.

The average surface water elevation within each TSF is estimated to be the lowest deposited tailings surface point plus 0.2 m (i.e. 0.2 m of standing water lies above the deposited tailings in each dam at any time). The estimated average water elevations are shown in Figure 7-3.

Table 7-1: TSF and IWL crest levels and low points

Status Start Date	Northern tailings storage facility				Southern tailings storage facility				Integrated Waste Landform			
	Stage	Operational Status	Crest Level (m AHD)	Low Point (m AHD)	Stage	Operational Status	Crest Level (m AHD)	Low Point (m AHD)	Stage	Operational Status	Crest Level (m AHD)	Low Point (m AHD)
1-Jan-06				213.0				213				213
20-Apr-06				213.0	1	Active	225.6	222.4				213
15-May-07	1	Active	222.0	218.8	1	Inactive	225.6	222.4				213
12-Sep-08	1	Inactive	222.0	218.8	2	Active	229.0	225.8				213
8-Dec-09	2	Active	225.0	221.8	2	Inactive	229.0	225.8				213
16-Jan-11	2	Inactive	225.0	221.8	3	Active	232.2	229.1				213
9-Mar-12	3	Active	228.2	225.1	3	Inactive	232.2	229.1				213
14-Jun-13	3	Inactive	228.2	225.1	4	Active	235.4	232.4				213
1-Sep-14	4	Active	231.7	228.7	4	Inactive	235.4	232.4				213
2-Nov-15	4	Inactive	231.7	228.7	5	Active	239.0	236.1				213
1-Dec-16	5	Active	236.0	233.1	5	Inactive	239.0	236.1				213
1-Mar-18	5	Inactive	236.0	233.1	6	Active	243.7	240.9				213
1-May-19	6	Active	240.5	237.7	6	Inactive	243.7	240.9				213
1-Jul-20	6	Inactive	240.5	237.7	7	Active	248.4	245.7	1	Active	221.5	220.1
1-Nov-21	6	Inactive	240.5	237.7	7	Inactive	248.4	245.7	1	Inactive	221.5	220.1
1-Nov-21	6	Inactive	240.5	237.7	7	Inactive	248.4	245.7	2	Active	228.0	225.2
1-Dec-22	6	Inactive	240.5	237.7	7	Inactive	248.4	245.7	2	Inactive	228.0	225.2
1-Dec-22	6	Inactive	240.5	237.7	7	Inactive	248.4	245.7	3	Active	228.0	225.2
1-Feb-24	6	Inactive	240.5	237.7	7	Inactive	248.4	245.7	4	Active	231.5	225.2
1-Apr-25	6	Inactive	240.5	237.7	7	Inactive	248.4	245.7	5	Active	236.5	228.7
1-Apr-27	6	Inactive	240.5	237.7	7	Inactive	248.4	245.7	6	Active	240.5	233.7
1-May-29	6	Inactive	240.5	237.7	7	Inactive	248.4	245.7	7	Active	245.0	237.7
1-Jul-32	6	Inactive	240.5	237.7	7	Inactive	248.4	245.7	8	Active	245.0	242.2
31-Dec-32	6	Inactive	240.5	237.7	7	Inactive	248.4	245.7	9	Active	246.0	243.2
31-Dec-33	6	Inactive	240.5	237.7	7	Inactive	248.4	245.7	10	Active	247.0	244.2
31-Dec-34	6	Inactive	240.5	237.7	7	Inactive	248.4	245.7	11	Active	248.0	245.2
31-Dec-35	6	Inactive	240.5	237.7	7	Inactive	248.4	245.7	12	Active	249.0	246.2
31-Dec-36	6	Inactive	240.5	237.7	7	Inactive	248.4	245.7	13	Active	250.0	247.2
31-Dec-37	6	Inactive	240.5	237.7	7	Inactive	248.4	245.7	14	Active	251.0	248.2

31-Dec-39	6	Inactive	240.5	237.7	7	Inactive	248.4	245.7	14	Inactive	251.0	248.2
-----------	---	----------	-------	-------	---	----------	-------	-------	----	----------	-------	-------

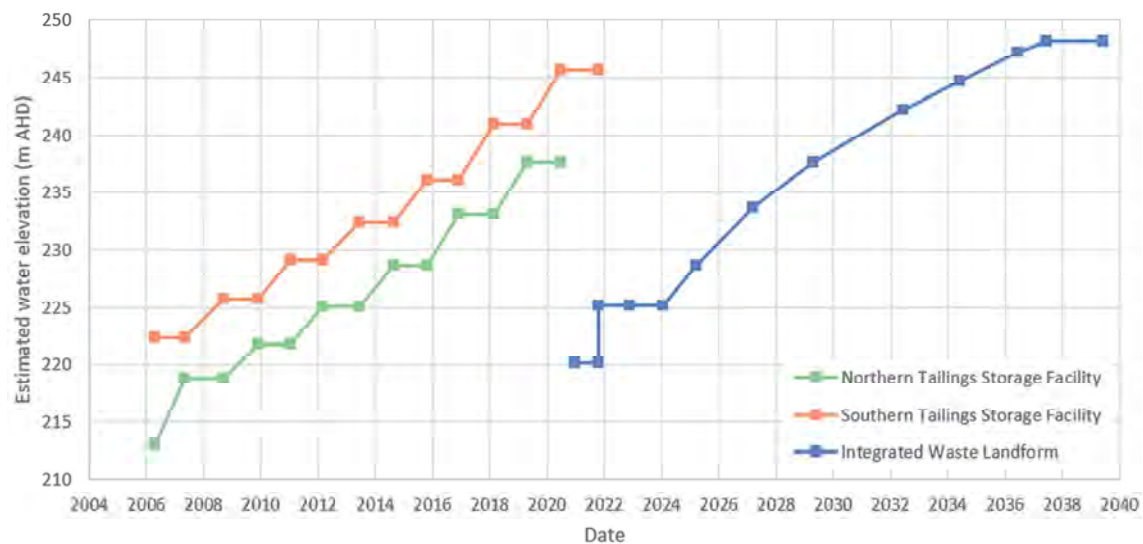

Figure 7-3: TSF and IWL water levels

The hydraulic conductivity of the TSF foundation material is lower than that of the deposited tailings and the surface water lying within the storage facility ponds is expected to maintain full hydraulic connection with the top of the TSF foundation material through the deposited tailings.

7.5 Paste fill

As part of the proposed underground mine operation, tailings paste will be used to produce a backfill to support the excavated stopes. This is discussed further in Section 9.1.7.

7.6 Proposed underground mine

7.6.1 Mine geometry

A sequence of stoping is proposed with development beginning in 2022. The proposed underground mining continues to mid-2039. In the horizontal direction, stoping will cover an area approximately 1500 m long running north from the eastern edge of the open pit and extending to approximately 800 m past the northern edge of the bund, as shown in Figure 7-4. The zone of stoping is approximately 100 m to 200 m in width. To the west of the stoping a network of access and haulage tunnels will extend approximately a further 200 m to the west.

In the vertical direction, the zone of stoping dips toward the east at an angle of approximately 72 degrees from the horizontal. The vertical extents of the stopes are approximately from 80 m AHD to -730 m AHD. Figure 7-5, Figure 7-6 and Figure 7-7 show the proposed stopes and access tunnels in plan and section and Figure 7-8 shows an isometric view.

Figure 7-9 shows the proposed timing of the stopes and access tunnel excavation, with selected times shown.

The proposed total mass of ore to be excavated from the stopes is 26,739,000 tonnes and the total length of access and haulage tunnels is 40 km (information provided by Evolution, reference: GRE-46_UG_SSD Design - Final - Capped at 1.8.xlsx).

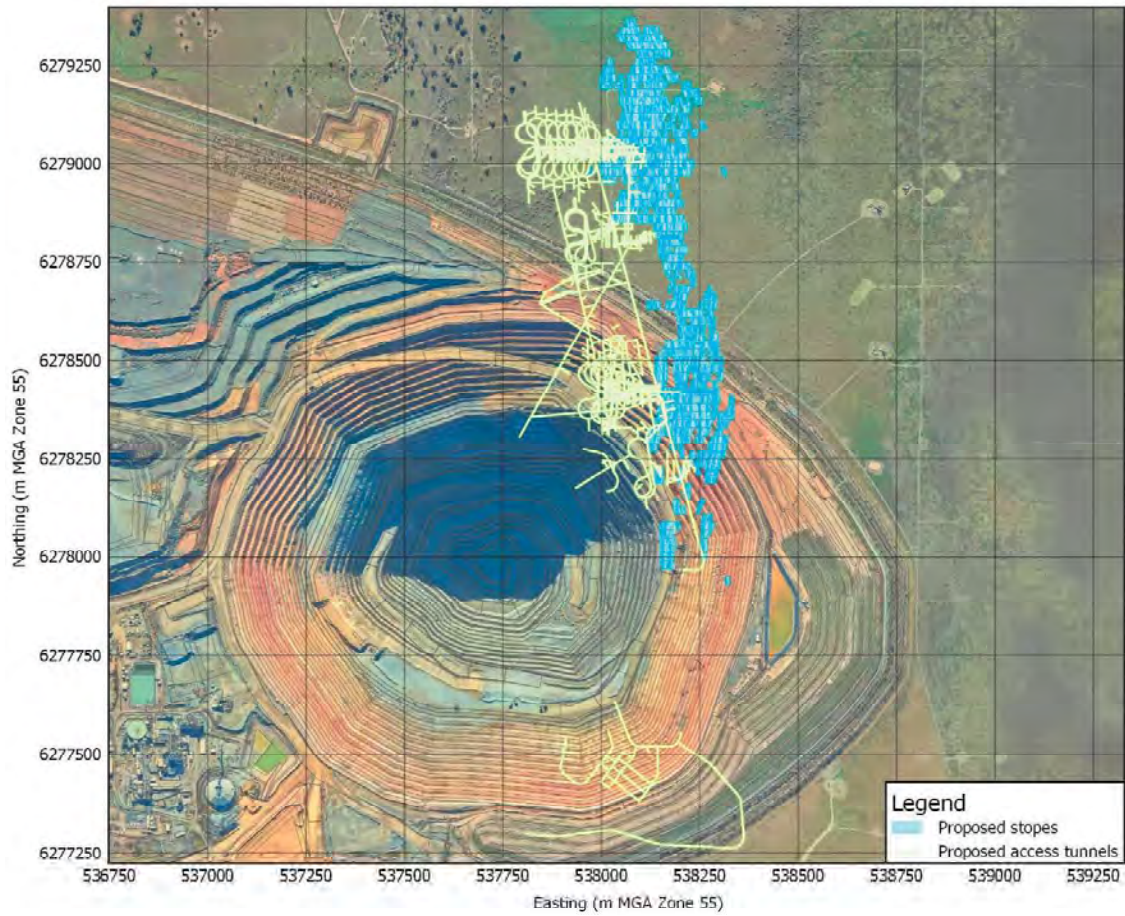

Figure 7-4: Detailed plan view of stopes area (Aerial imagery provided by Evolution Mining, December 2019)

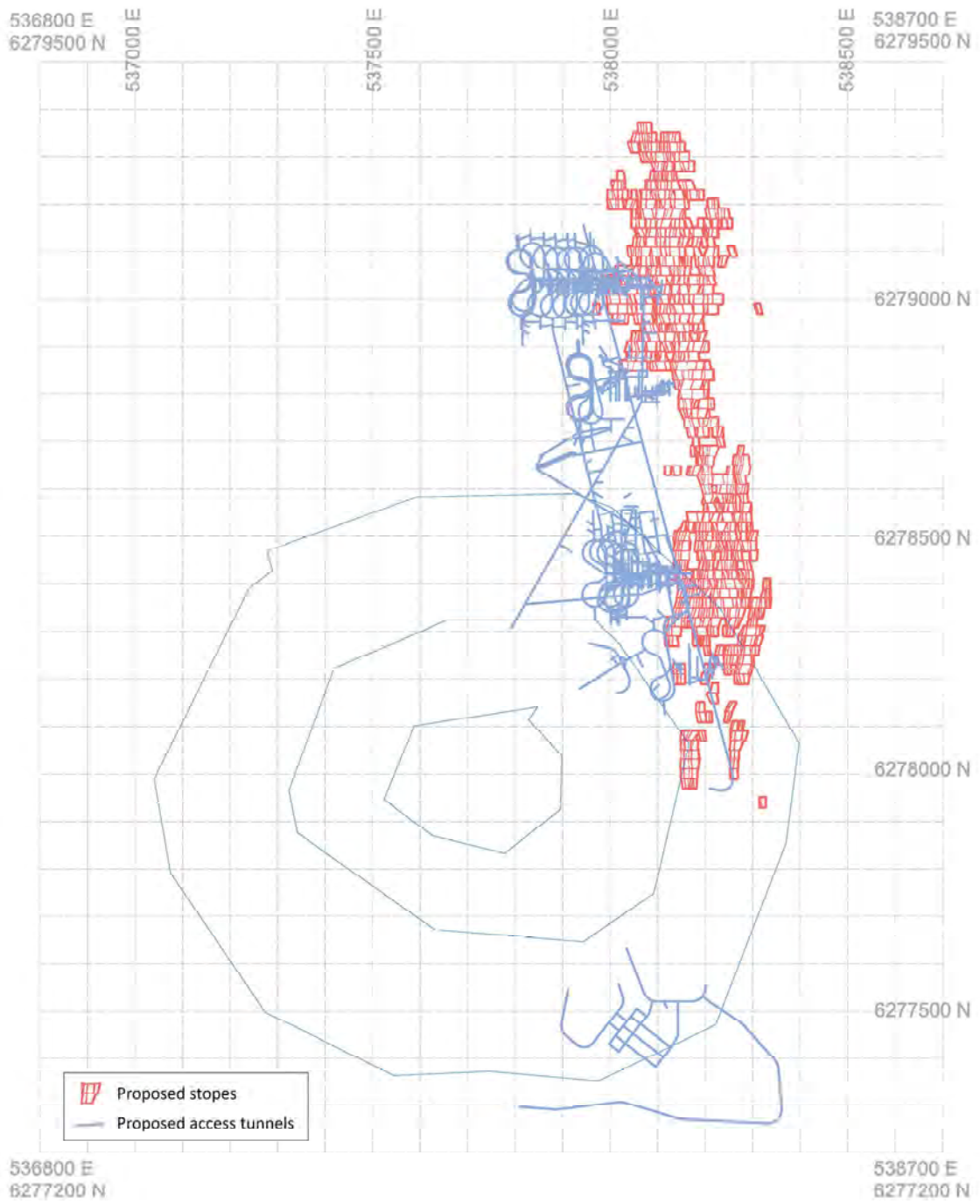

Figure 7-5: Stopes and access tunnels - plan view (m MGA Zone 55)

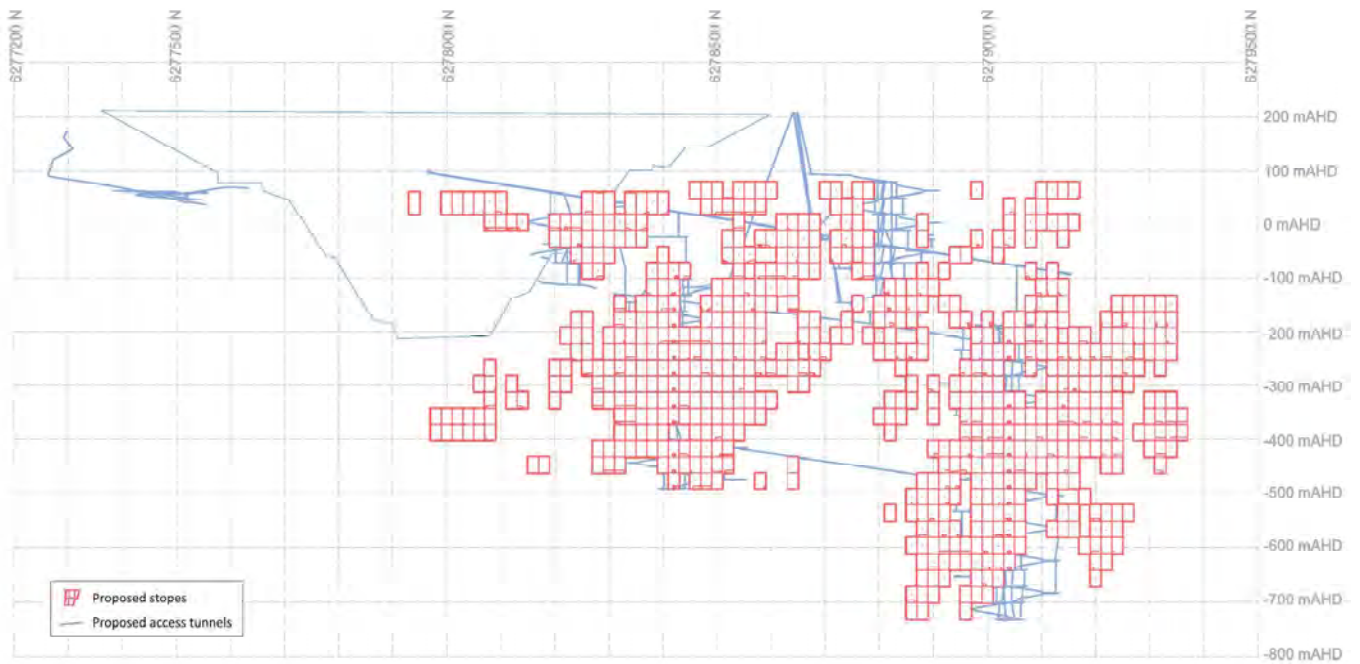

Figure 7-6: Stopes and access tunnels - elevation view looking west (Northings in m MGA Zone 55)

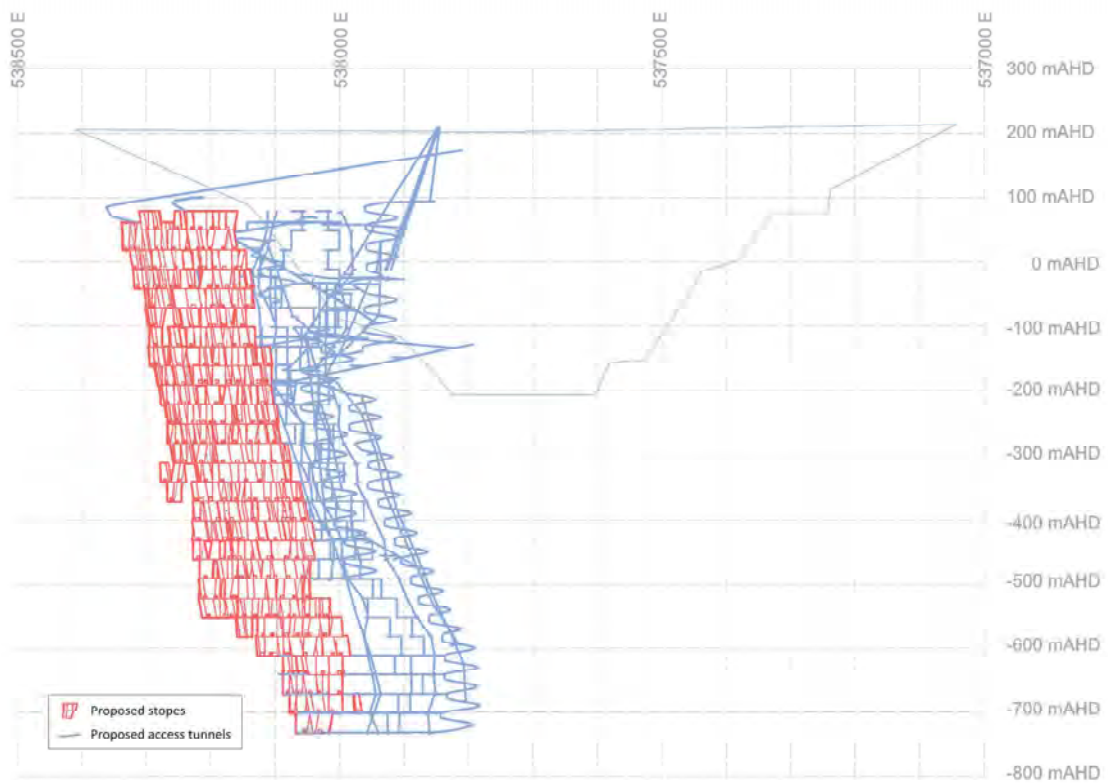

Figure 7-7: Stopes and access tunnels - elevation view looking south (Eastings in m MGA Zone 55)

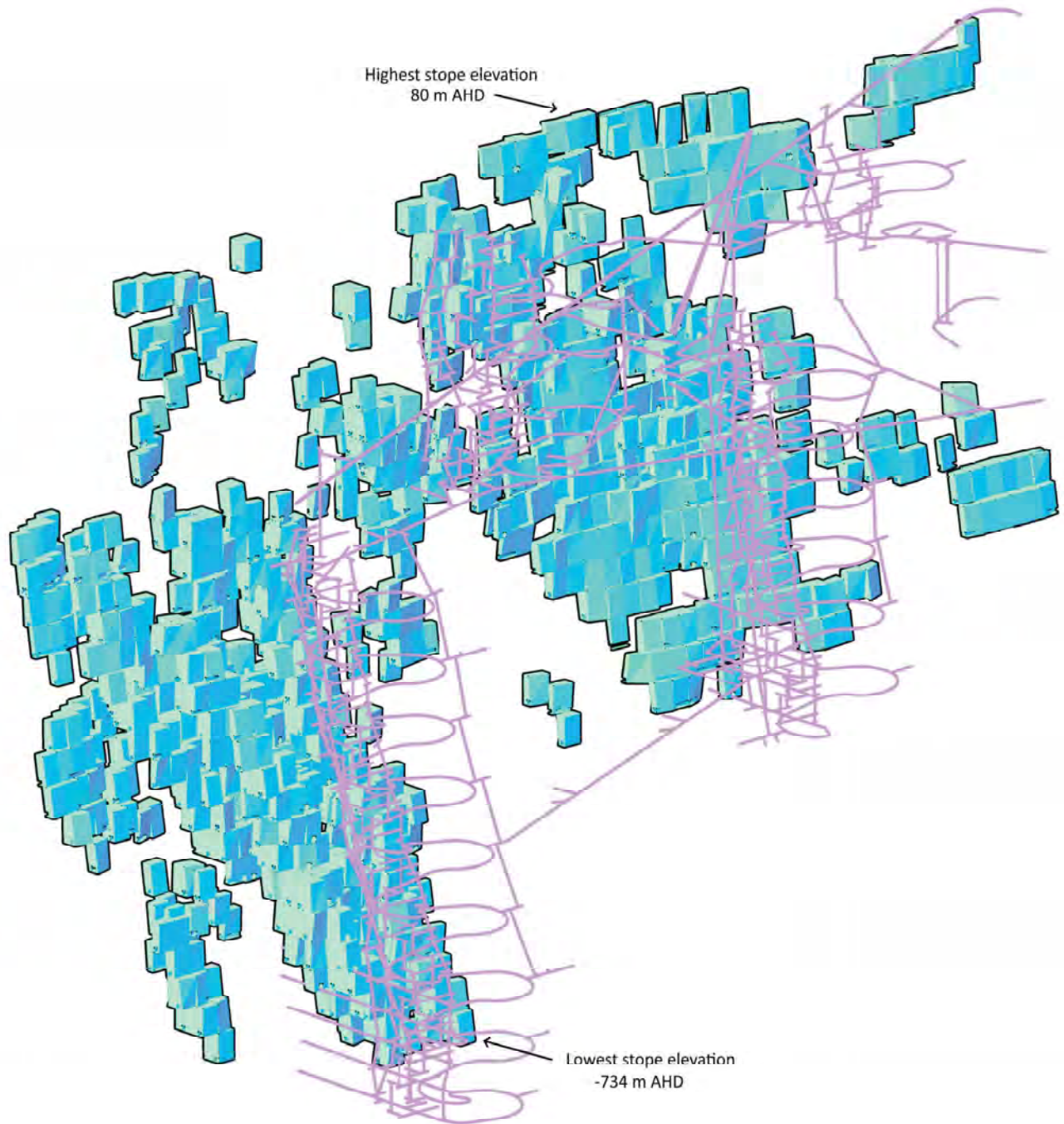

Figure 7-8: Stopes and access tunnels - isometric view from the west

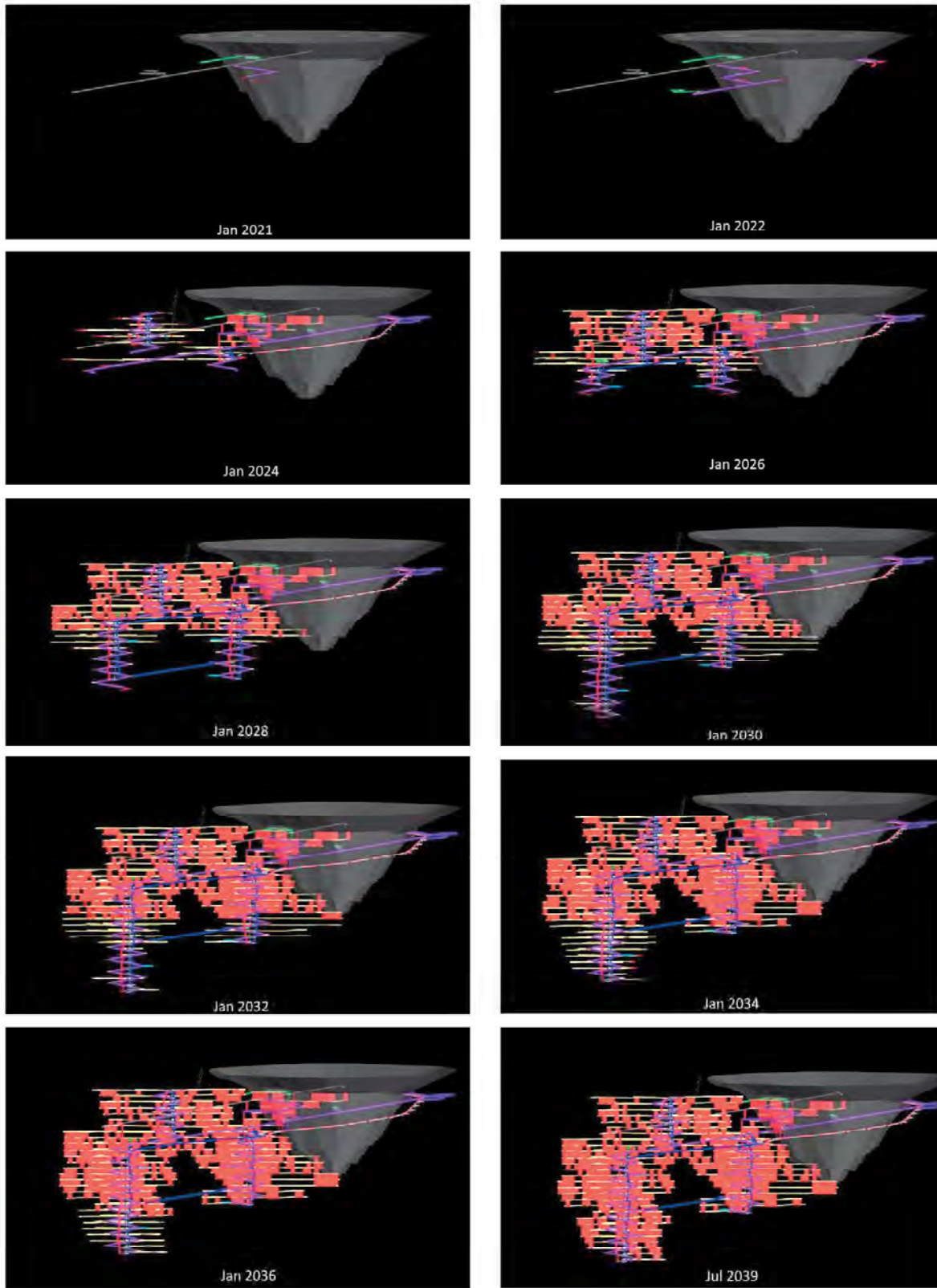

Figure 7-9: Stopes and access tunnel excavation timing

8 Numerical model development

A three-dimensional numerical groundwater flow model was developed using the proprietary software Feflow, Version 7.2. The model was used to calibrate hydraulic conductivity, specific storage and rainfall infiltration rates for the conceptual hydrogeological model, based on observed groundwater heads, open pit excavation progress and interpreted pit inflows for the period 1 January 2005 to 1 January 2020.

The calibrated model was then used to predict the impacts from the proposed underground mine on local groundwater levels and flow directions and to predict the rates of groundwater inflow into the proposed underground mine.

Previous modelling has been carried out for the mine site. These models were calibrated based on the available monitoring data and pit inflow records at the time and provide a comparison to calibrated parameters obtained from the current numerical model, which is based on a longer set of monitoring data. Details of previous modelling is described in the following reports:

- Cowal Gold Operations Processing Rate Modification (MOD14), Mine Site Hydrogeological Assessment, Coffey Report No. 754-SYDGE206418-AA, dated 2 March 2018.
- Cowal Gold Mine, Groundwater Level Investigation, Coffey Report No. GEOTLCOV21910AF-AB, dated 26 March 2009.
- Cowal Gold Mine, Pit Dewatering Assessment, Coffey Report No. GEOTLCOV21910AC-AC, dated 5 August 2008.

Due to the significant re-design of the model mesh required to model the proposed stopes and access tunnels, the numerical model described in this report was developed and calibrated as a new model, rather than as an extension of previous models.

8.1 Conceptual model

8.1.1 Model domain, layers and discretisation

8.1.1.1 Domain

The model domain is centred approximately on the area between the existing open pit and the tailings storage facilities.

- The model western boundary is located approximately 10 km to the west of the open pit and follows a gentle north south ridge which reaches elevations of between 280 m AHD and 310 m AHD.
- The model eastern boundary is approximately 2 km east of the centre of Lake Cowal, located approximately 7 km east of the open pit.
- The model northern and southern boundaries are located approximately 7 km and 8 km from the open pit respectively. The northern boundary passes through Wamboyne Mountain which reaches an elevation of over 390 m AHD. There were no distinct topographic or geological features for the southern boundary.
- The model extents are 16.6 km east-west and 15.1 km north-south.

These extents were selected to be of such distance from the mine so that conditions at the model boundaries do not influence the model at the mine area over the mine life. Figure 8-1 shows the model boundary.

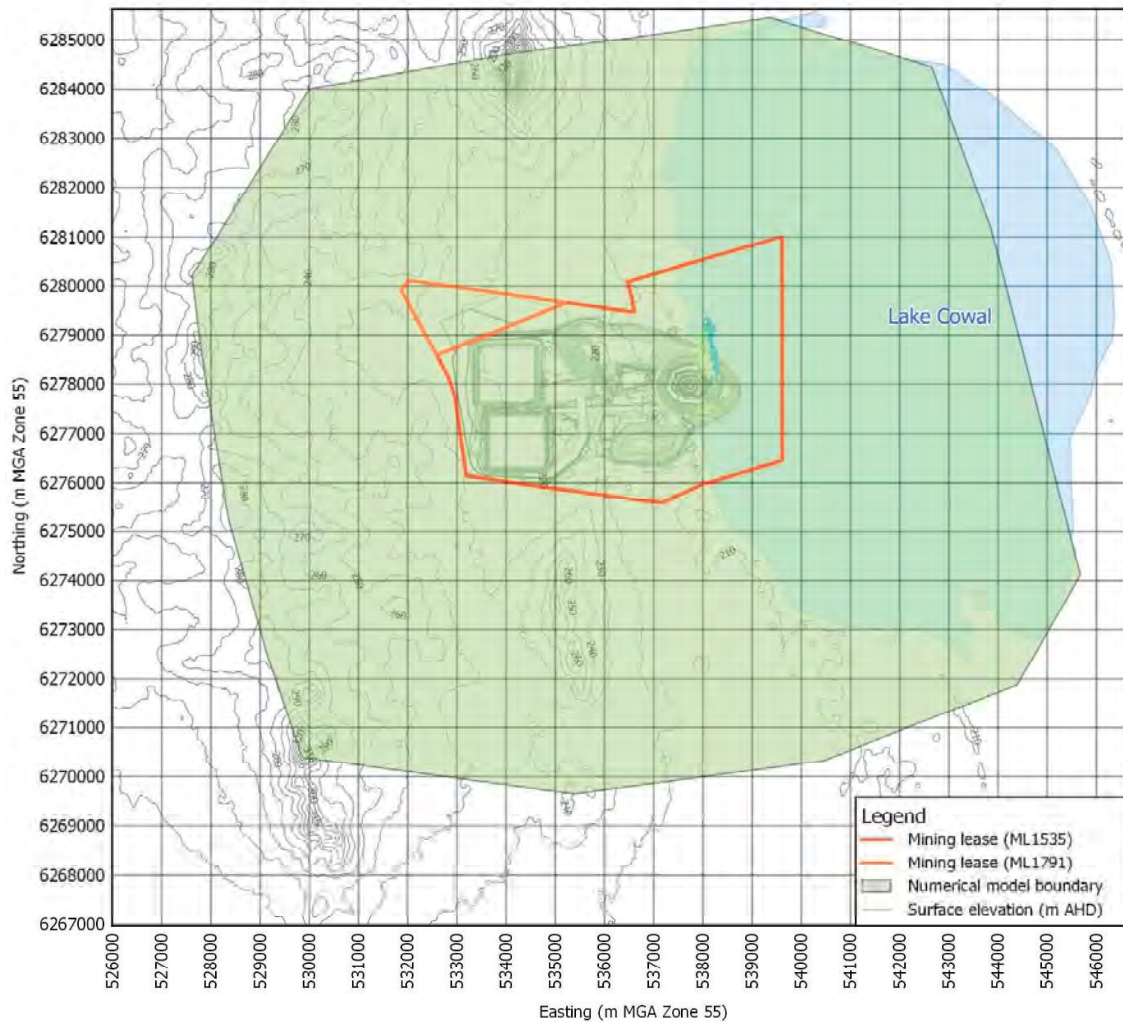

Figure 8-1: Model domain

8.1.1.2 Vertical layers

The model was divided into 19 vertical layers. The top of the model was taken as the ground surface from a 1 second resolution digital elevation model sourced from ELVIS (<https://elevation.fsd.org.au/>), a publicly available topographic data set released by the Australian and New Zealand Spatial Information Council (ANZLIC).

The model vertical layers represent the hydrogeological units as follows:

- Transported unit: Model layers 1 and 2, excluding the areas in layer 1 under the TSFs and IWL
- Saprolite unit: Model layers 3 and 4
- Saprock unit: Model layer 5

- Primary Rock unit: Model layers 6 to 19
- TSF and IWL: Model layer 1 under the TSF and IWL footprints only

The base of Transported, Saprolite and Saprock units in the area of the proposed underground mine were interpreted from the excavation borehole logs. The base of the Transported unit east of the mine, in the area shown in Figure 6-7, was interpreted from the gravity survey data, as discussed in section 6.4. Outside of these areas, the base of the units was set to a constant value.

The Primary Rock unit base of model layer elevations were set at 100, 50, 0, -100, -200, -300, -400, -500, -600, -700, -800, -1,000, -1,250 and -1,600 m AHD. The base of the model elevation was selected to be over 800 m below the base of the lowest of the proposed stopes. Figure 8-2 and Figure 8-3 show views of the open pit and stopes elements as represented in the model.

Based upon assessment of the modelled groundwater table near the open pit, the model layers representing the Transported, Saprolite and Saprock units were set as unconfined and the model layers representing the Primary Rock were set as confined.

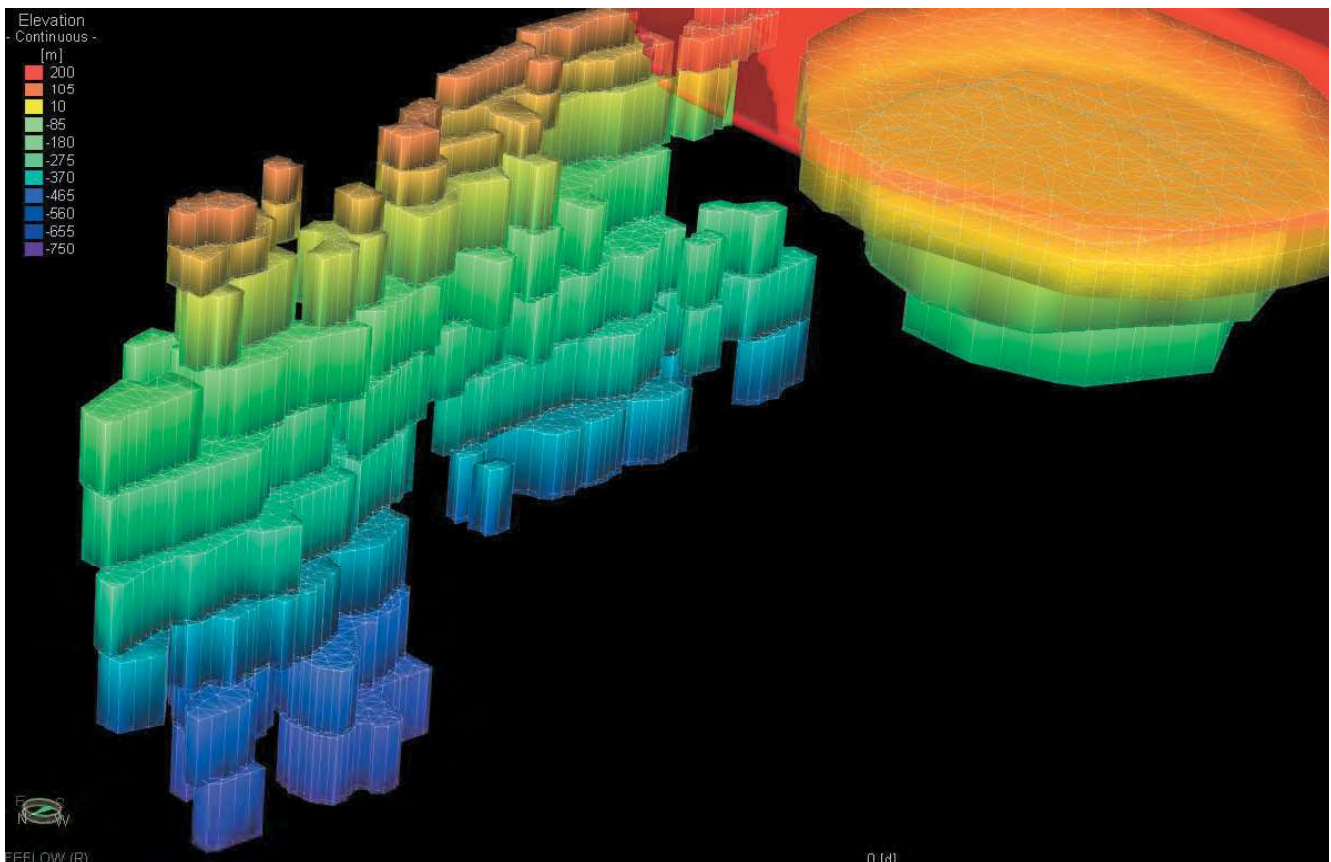

Figure 8-2: View of the open pit and stopes elements as represented in the model, viewed from the north west

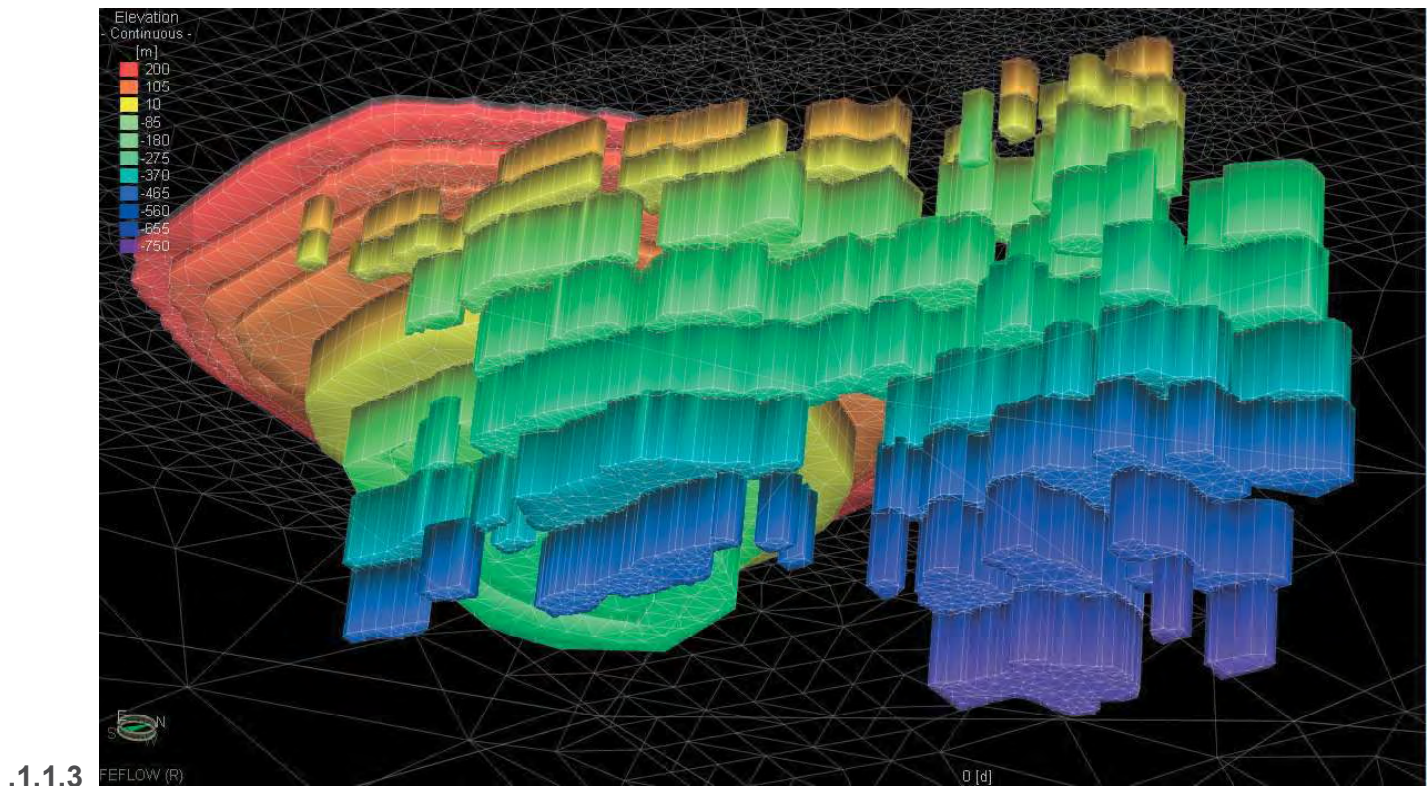

Figure 8-3: View of the stopes and open pit elements as represented in the model, viewed from underneath from the north east

8.1.1.4 Open Pit

The geometry of open pit was provided by Evolution Mining for the years 2020 to 2024. Polygons were created for the intersection of the open pit and the elevations 187.5, 162.5, 137.5, 112.5, 50, -50 and -150 m AHD. These elevations represented the midpoints of the Transported, Saprolite and Saprock units and of layer 6, layer 7, layer 8 and layer 9 in the Primary Rock unit. The open pit was represented in the model as seven blocks in the abovementioned units and/or layers which were turned off sequentially as the pit excavation proceeded with seepage faces applied to allow seepage from the pit sides, as shown in Figure 8-8.

8.1.1.5 Tailings storage facilities and Integrated Waste Landform

The location of the tailings storage facilities including the planned Integrated Waste Landform were taken from CAD files provided by Evolution Mining.

8.1.1.6 Mesh

The model mesh was created using an unstructured triangular meshing (Delaunay Triangulation). A number of input points were specified prior to running the triangulation in order to control the mesh around the open pit, TSFs and IWL and the proposed stopes and access tunnels. This avoided automated refinement on intersecting or curved input lines or very close points, which commonly happens in a constrained Delaunay Triangulation and which can result in many more model elements than are necessary.

The model consists of 187,644 elements and 99,620 nodes. Figure 8-4 shows a plan view of the mesh. Figure 8-5 shows a close up of the mesh in the vicinity of the stopes and open pit.

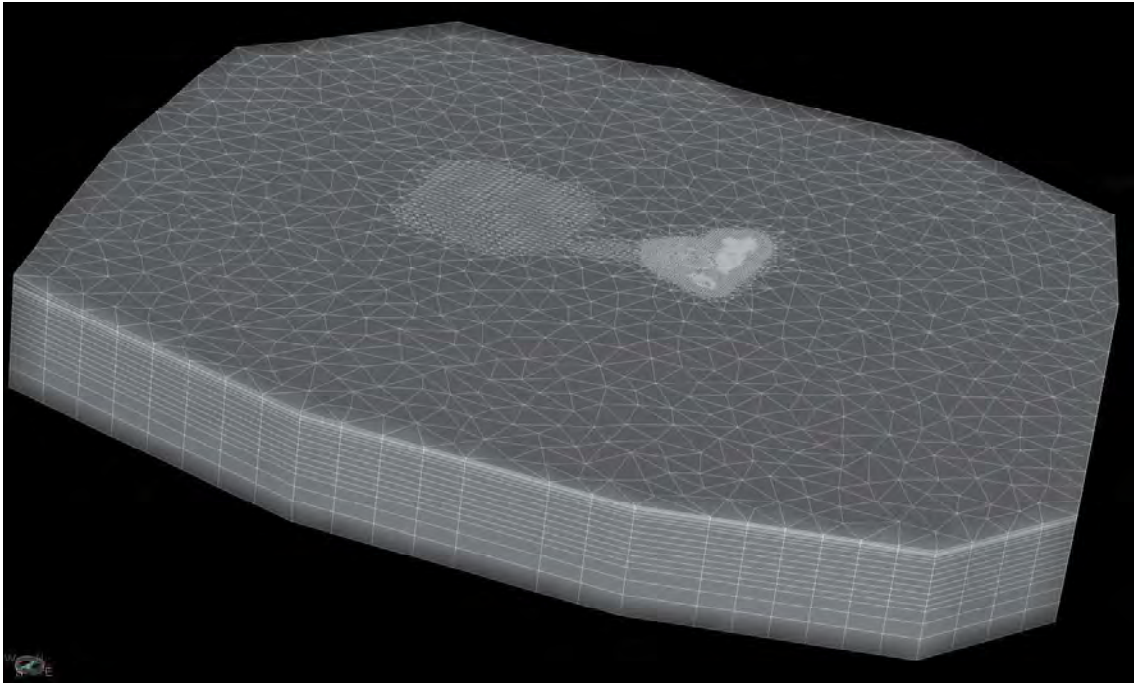

Figure 8-4: Mesh

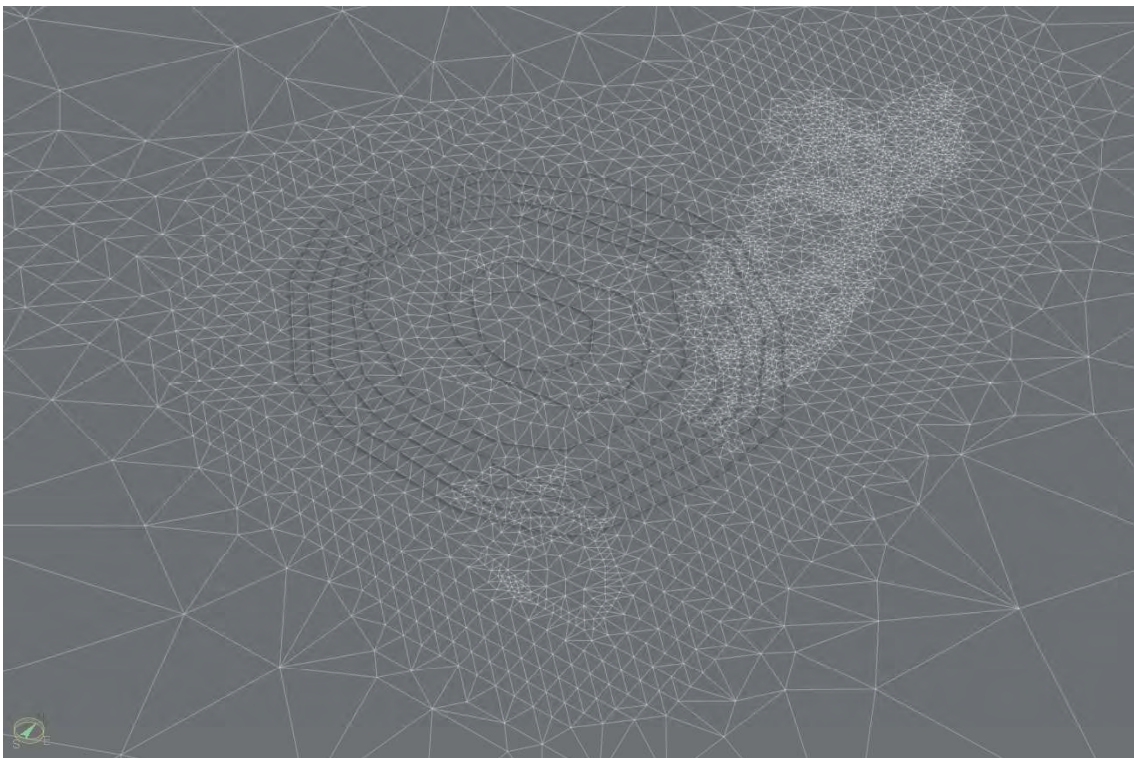

Figure 8-5: Mesh detail near open pit and stopes

8.1.2 Boundary conditions

Constant fixed head or no flow boundary conditions were applied to all nodes on the western, eastern, northern and southern model boundaries of the model. These fixed heads were selected based on a steady state calibration against 2004 monitoring well data near the open pit, prior to open pit mining. The steady state calibration was for the purposes of obtaining starting heads over the model domain for 1 January 2004. Rainfall recharge was not applied to the steady state calibration.

The following fixed heads were applied to the model boundaries:

- 198 m AHD on the eastern boundary.
- 205 m AHD along the western boundary.
- Time varying fixed head for Lake Cowal.
- No flow along the southern boundary.
- No flow along the northern boundary.

Figure 8-6 shows the location of the model boundary conditions.

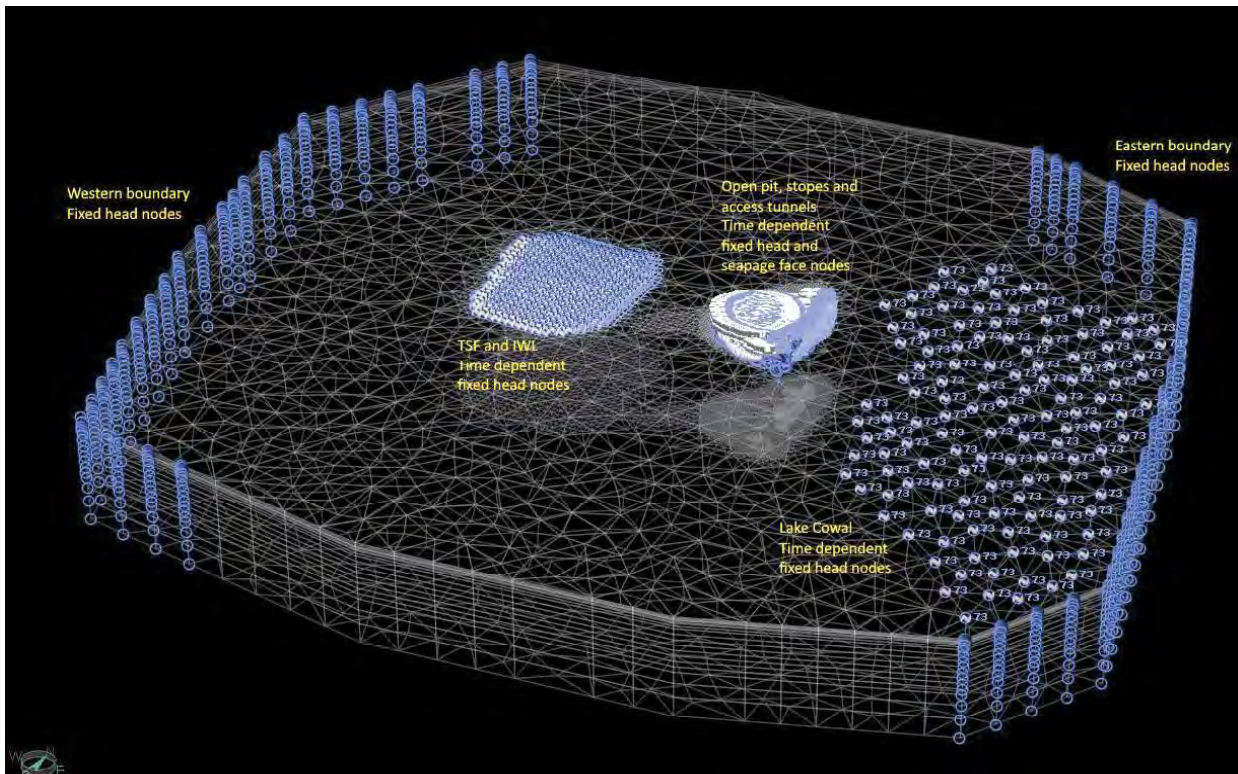

Figure 8-6: Location of model boundary conditions

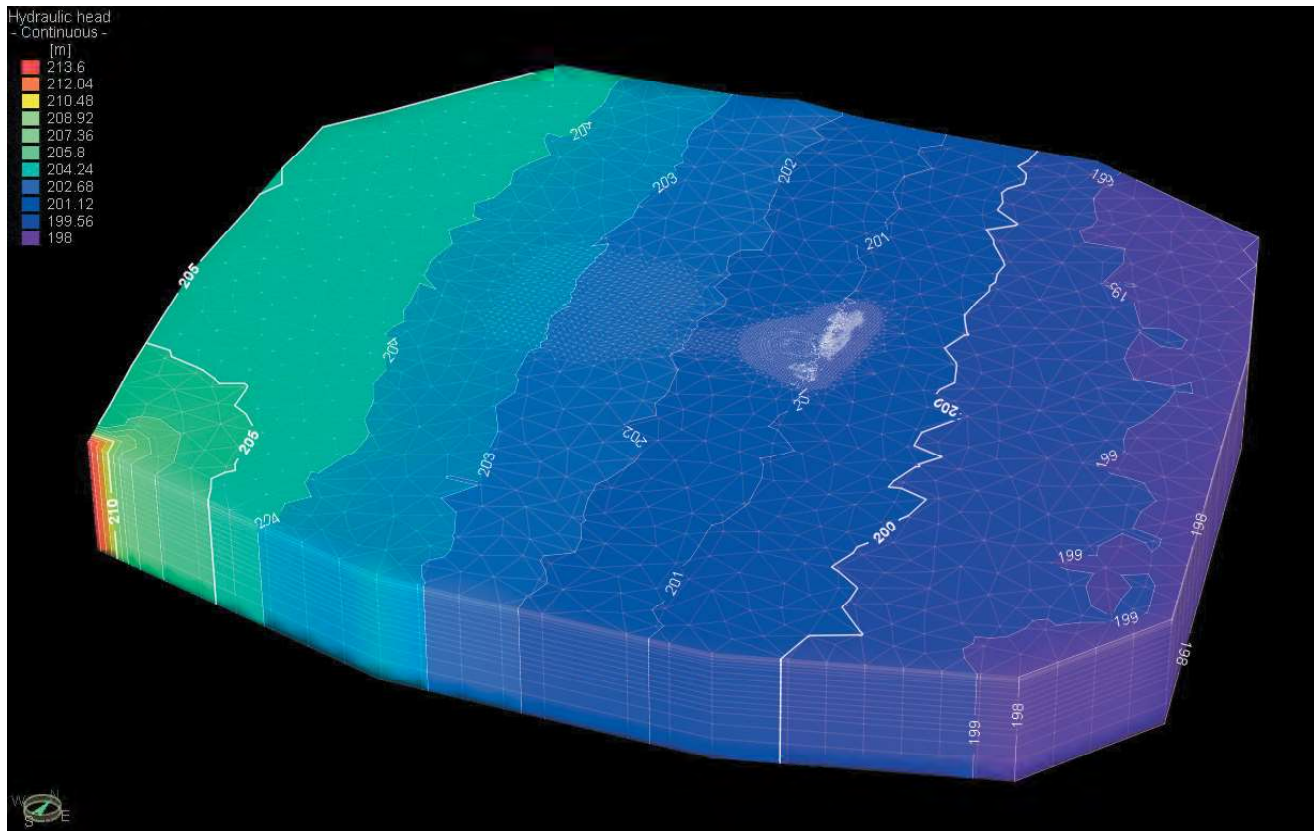

Figure 8-7: Model groundwater heads for 1 January 2004

8.1.2.1 Open Pit

The excavation of the open pit was represented by applying time varying fixed head boundary conditions, not always active, to the base of the pit. Seepage face boundary conditions were applied to the open pit sides. As the pit excavation progressed, blocks of the model were deactivated to represent the pit void.

The process is illustrated in Figure 8-8. The modelled base of pit level is shown in Figure 8-9.

8.1.2.2 Dewatering bores

Mine site pit dewatering was undertaken on site by pumping from pit sumps and from a number of vertical boreholes between 2005 and 2011. In October 2011, the inner group of vertical dewatering bores were decommissioned and a new group of dewatering bores, at further distance from the open pit, were commissioned. During 2011 and 2012, horizontal drains were installed at the eastern side of the open pit at approximately 100 m AHD elevation to aid in depressurisation of the eastern face. Subsequently additional horizontal drains were installed. Figure 8-10 shows the location of the dewatering bores in relation to the edges of the modelled open pit blocks, as shown in Figure 8-2.

The inner group of dewatering bores and bores PD106 and PD107 are located on or inside the modelled pit blocks. These bores were accounted for in the model by seepage faces and fixed head conditions applied to the open pit blocks. The remainder of the bores lie outside the eastern edge of the outermost modelled open pit block. These bores and the horizontal drains were installed between 2011 and 2012. They were represented in the model by seepage faces being applied to a zone of nodes from February 2011 to January 2020, at two node levels at the interface between the Saprock unit and the Primary rock unit (approximate elevation 110 m to 100 m AHD). Figure 8-11 shows the

location of the model seepage face nodes used to model the effects of the dewatering bores and horizontal drains.

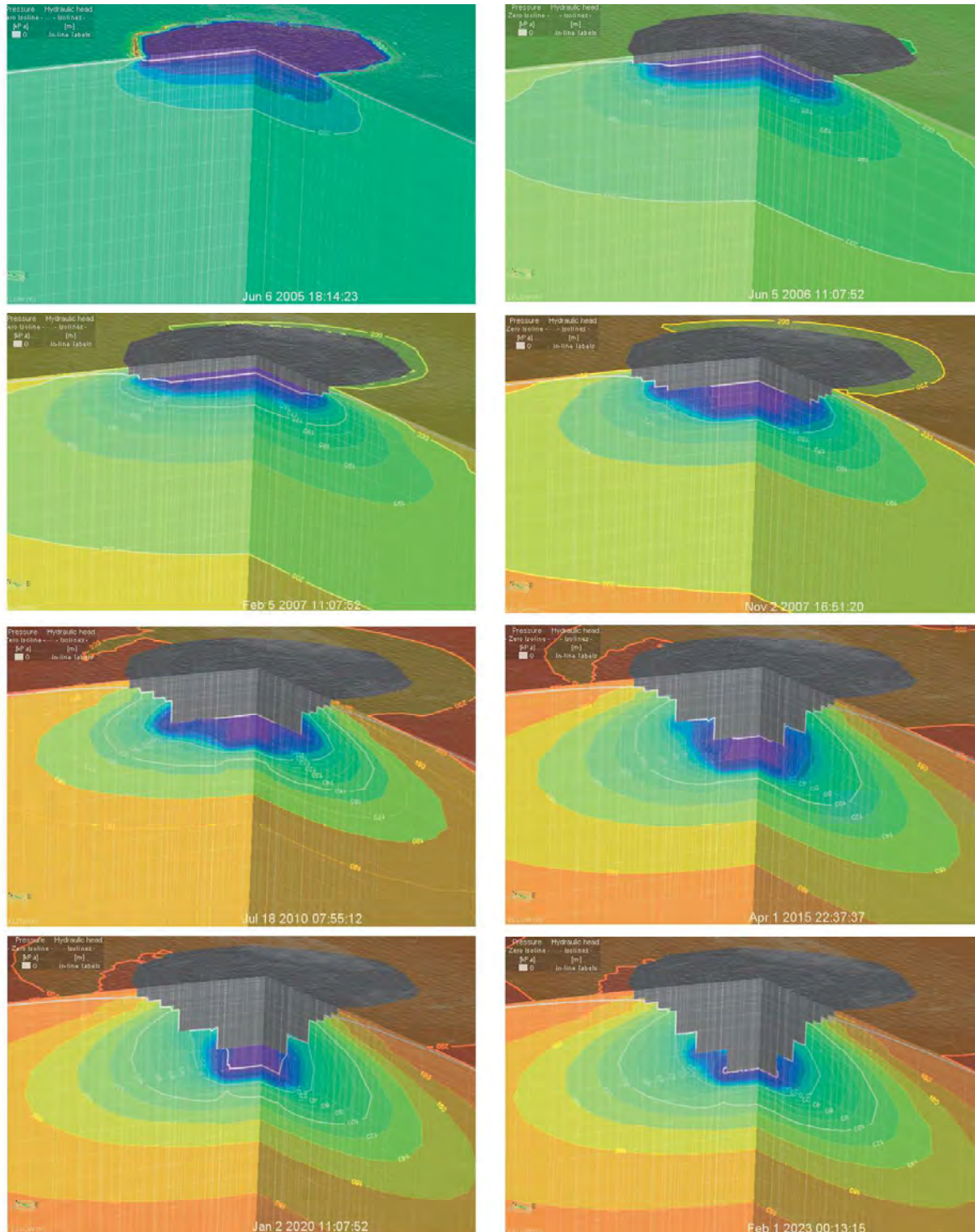

Figure 8-8: Modelling of open pit excavation sequence (contours show hydraulic head, grey signifies inactive elements representing the open pit and the white line shows the water table)

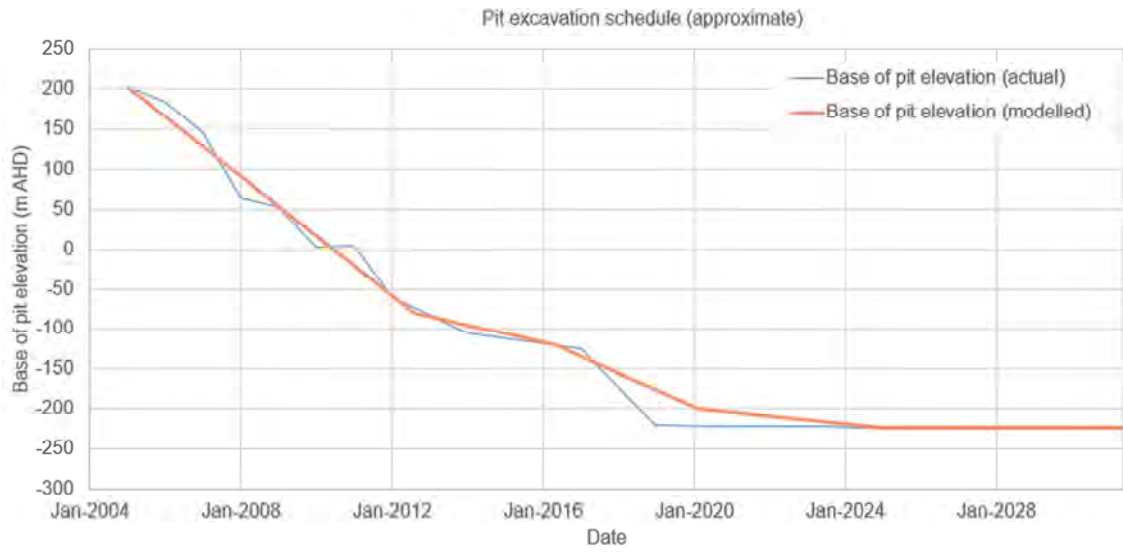

Figure 8-9: Modelled base of pit elevation

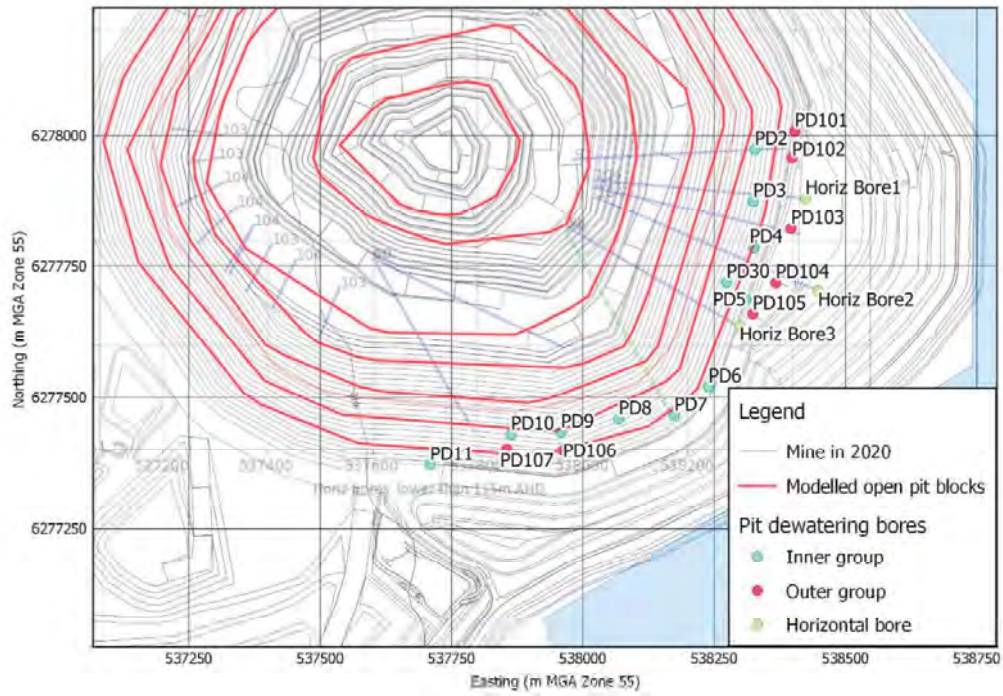

Figure 8-10: Pit dewatering bores

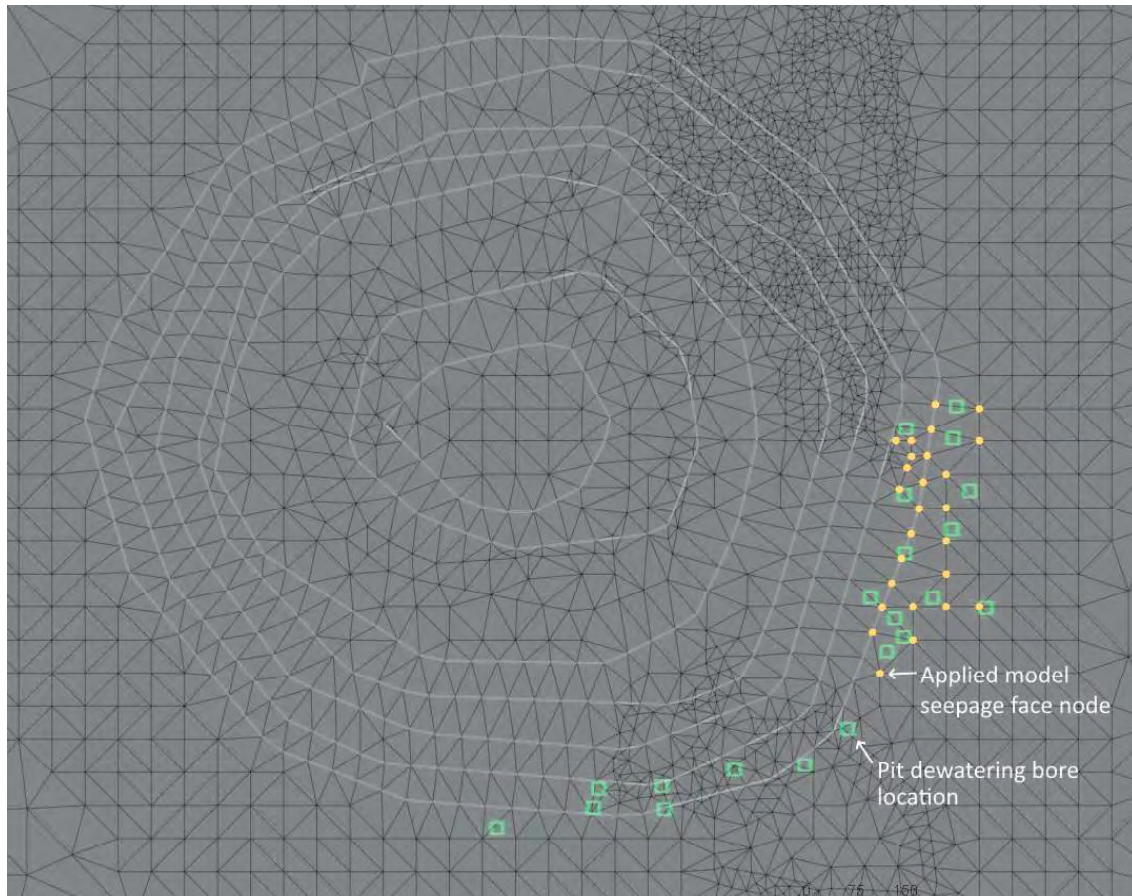

Figure 8-11: Representation of eastern pit dewatering bores in model

8.1.2.3 Tailings storage facilities

Time varying head boundary conditions were applied to the nodes representing the north and south tailings storage facilities. The time series were adopted from Table 7-1 and are shown in Figure 8-12.

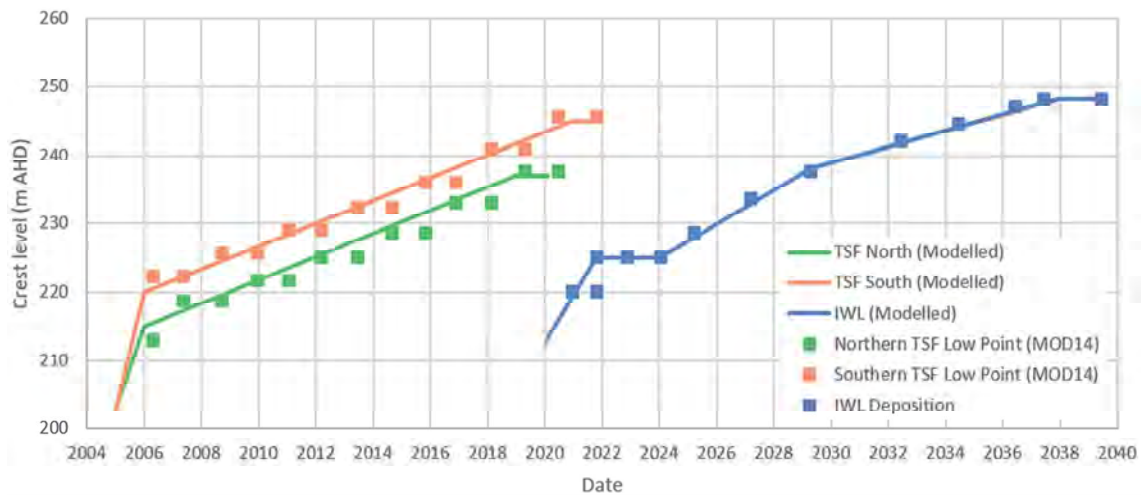

Figure 8-12: Modelled crest levels (time varying fixed head boundary conditions) for the TSFs and IWL

8.1.2.4 Lake Cowal

A time varying fixed head was applied to the surface nodes in the area of Lake Cowal. The observed and modelled water levels for Lake Cowal are shown in Figure 8-13.

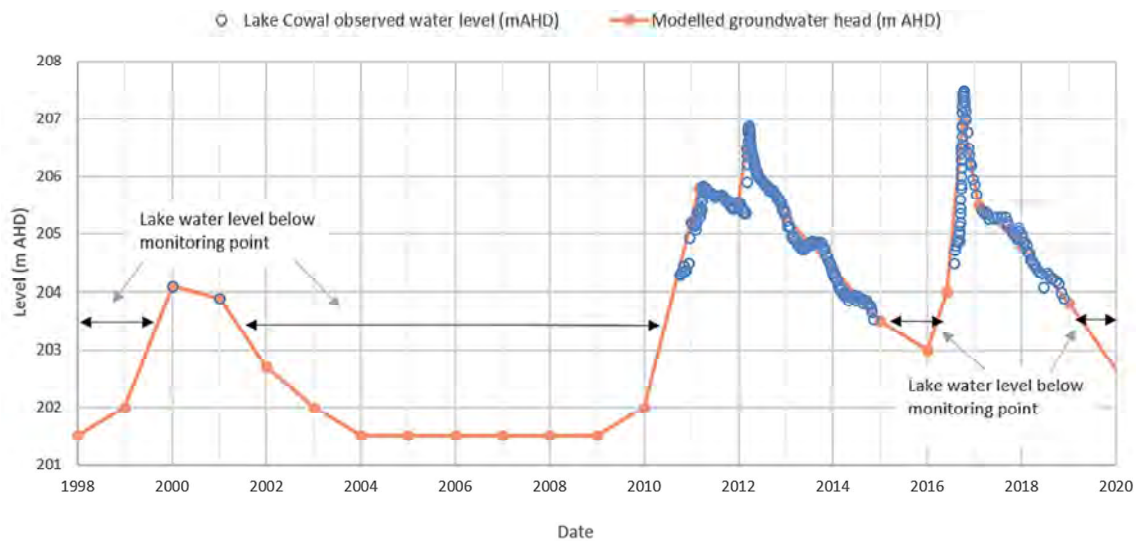

Figure 8-13: Lake Cowal observed and modelled water levels from 1998 to 2020

8.1.2.5 Rainfall infiltration

Rainfall infiltration was applied uniformly to the top layer of the model, with a calibrated value of 6.9×10^{-6} m/d. This represents 0.6% of the average annual rainfall.

8.2 Model calibration

8.2.1 PEST

Model calibration is the selection of the optimum input parameter values so that the model attains the closest fit to real world observation data.

Model calibration for this assessment was done using the open source software PEST (developed by John Doherty at Watermark Numerical Computing). Using PEST, the conceptual model units are defined and assumed to have constant parameter values over their extents. PEST runs the model multiple times with the object of minimising the differences between modelled groundwater heads and the measured groundwater heads at a set of provided observation wells. This is done by means of a mathematical 'objective function' which is the sum of the squares of the differences between modelled and observed groundwater heads. Further details can be found in the PEST user manual (Watermark Numerical Computing, 2004).

The more zones and/or parameters there are to vary, the more runs of the model PEST will have to make. There is a significant computation time increase as the number of model elements increases, until the time required for PEST becomes prohibitive.

The model was calibrated using FePest Version 7.2 which is a graphical user interface between Feflow and PEST.

The automated calibration method in this assessment using PEST differs from previous calibrations (e.g. Coffey, 2018a) which were done using non-automated processes.

8.2.2 Model parameter zones

Model parameter zones were selected based on the model domain discussed in Section 8.1.1, these are:

- Transported unit: Model layers 1 and 2, excluding the area in layer 1 under the TSFs.
- Saprolite unit: Model layers 3 and 4.
- Saprock unit: Model layer 5.
- Primary Rock unit: Model layers 6 to 19.

8.2.3 Parameters

For each of the four model zones, the following parameters were allowed to vary until values were found by PEST which minimised the objective function:

- Hydraulic conductivity in two horizontal directions, north-south and east-west.
- Hydraulic conductivity in the vertical direction.
- Specific storage.

The hydraulic conductivity in the north-south direction was set to equal twice the hydraulic conductivity in the east-west direction in order to account for the regional geological structure.

For the TSF foundations, the hydraulic conductivity in the vertical direction was calibrated manually (without PEST). The north-south and east-west hydraulic conductivity for the TSF foundations were set at 1×10^{-4} m/day, adopting the values from the MOD14 assessment (Coffey, 2018a).

Specific yield was not calibrated.

8.2.4 Field observations

A total of 22 piezometers with data for the period 1 Jan 2004 to 1 Jan 2020 were used to calibrate the model. Monitoring data from these piezometers is reported by Coffey (2020b) and included as Appendix A. Piezometer details are shown in Table 6-1.

The piezometers at the processing plant were not used in model calibration as the local effects from water storage at the processing plant were not modelled. As described below, PDB3A is influenced by localised dewatering of the eastern open pit face. These local effects are not captured in sufficient detail by the model and so PDB3A was excluded from the calibration to avoid it unduly influencing the calibration results.

Additional monitoring data from piezometers UG-BH-01, UG-BH-02, UG-BH-03 and UG-BH-04, installed in February 2020, and PZ13 which was activated in August 2019, were considered in the calibration. Results from these piezometers led to improvements to earlier calibrations for the Saprock and Primary Rock units. This was evident in improvement in the match between the observed drawdown and the modelled drawdown at the deepest piezometers at UG-BH-01 and UG-BH-02 compared with earlier calibrations which were developed prior to availability of these monitoring records. In particular, the ratio of horizontal to vertical hydraulic conductivity in the Saprock and Primary Rock in the earlier models appeared too low. This was a result of influence of the measurements at borehole PDB3A on a previous calibration. It being one of the only existing piezometers in the Primary Rock. PDB3A is influenced by localised dewatering of the eastern open pit face. This localised dewatering depends on short term pumping rates and individual dewatering bore locations and is not captured in sufficient detail by the regional scale numerical groundwater model.

Following an initial calibration in PEST, the ratio of horizontal to vertical hydraulic conductivity in the Saprock and Primary Rock units was adjusted manually until a reasonable balance was found which provided a closer match to monitoring results at UG-BH-01 and UG-BH-02. This ratio was found to be 0.1 for both units. Further calibration was then done using PEST, with the ratio of horizontal to vertical hydraulic conductivity in the Saprock and Primary Rock units set to 0.1. These PEST runs excluded PDB3A for the reasons described above.

Monitoring results at UG-BH-03, UG-BH-04 and PZ13 were assessed to be significantly influenced by the GRE46 exploration decline and associated exploration drilling and so were not incorporated into the final calibration.

The locations of the piezometers used for the calibration are shown in Figure 8-14.

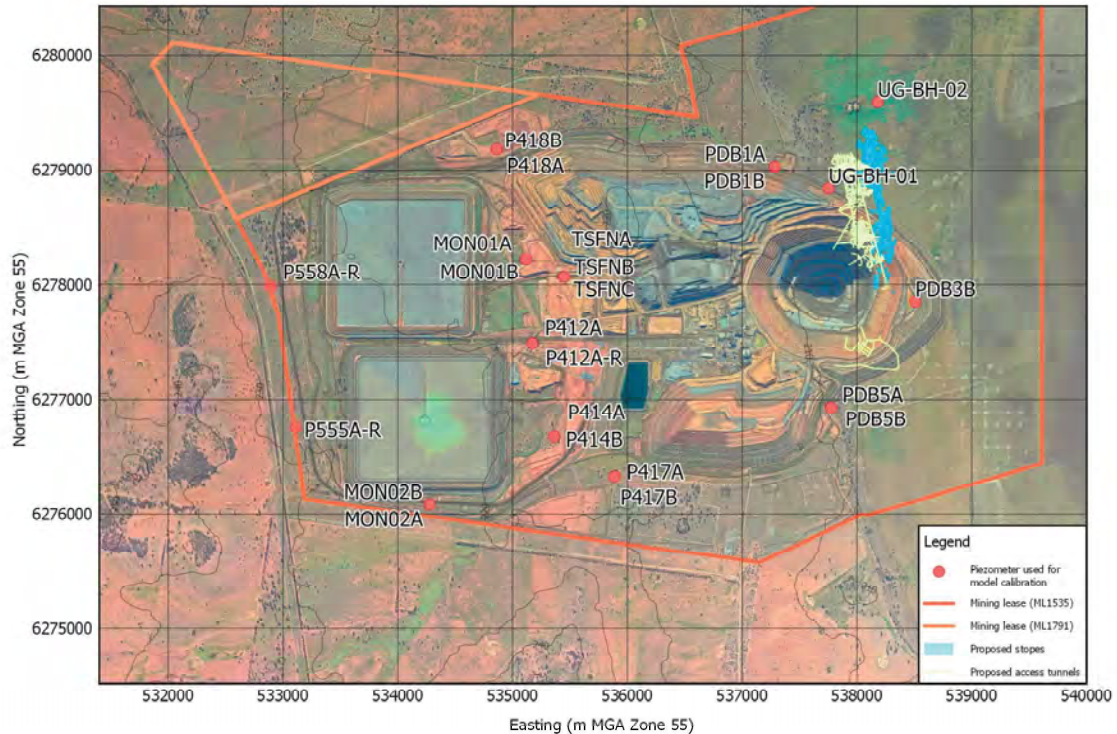

Figure 8-14: Locations of piezometers used for model calibration

8.2.5 Inflow to open pit

The observed inflow to the open pit, as shown in Figure 8-18, is heavily affected by rainfall and other external factors. Over some time periods, for example July 2012 to December 2012 and July 2014 to December 2014, there is almost no inflow recorded to the open pit. For this reason, the observed inflow to the open pit was incorporated to the model calibration after the PEST calibration to observed groundwater heads.

For the calibration runs the driving influence is the change in head imposed at the surface of the pit as the pit development takes place. Under these conditions if all hydraulic conductivity values are scaled by the same amount and the ratio of storage parameters to hydraulic conductivity are maintained the drawdown results will be essentially unchanged and only the rate of seepage to the pit will vary. Rainfall infiltration is a secondary factor during the calibration period. In order to maintain a consistent response rainfall infiltration needs to be scaled with the same factor as applied to hydraulic conductivity. Applying this process allows adjustment of the results of calibration runs (carried out to match the drawdown response with time) to match a selected seepage rate to the mine pit.

Following calibration against observed groundwater heads using PEST, modelled and observed inflow rates to the open pit were compared for the period January 2018 to January 2020. The calibrated hydraulic conductivity, specific storage and rainfall recharge parameters were then scaled by the same amount required to provide a reasonable match to observed inflow rates to the open pit for this period. As discussed above, this does not affect the calibration of the model to observed groundwater heads.

Modelled versus observed inflow to the open pit can be seen in Figure 8-18. Uncertainty in the observed inflow to the open pit is considered in Section 8.3.

8.2.6 Results

The calibrated model parameters are shown in Table 8-1.

Table 8-1: Calibrated parameters adopted for the current model

Hydrogeological Unit	Model Layers	Hydraulic Conductivity (m/d)			Specific storage (m ⁻¹)	Specific Yield	Inflow to top of layer (m/d)
		K _{xx} (east-west)	K _{yy} (north-south)	K _{zz} (vertical)			
Transported unit	1 and 2	2.2 x 10 ⁻²	2.2 x 10 ⁻²	9.9 x 10 ⁻⁴	4.8 x 10 ⁻⁴	0.2 ⁽³⁾	6.9 x 10 ⁻⁶
Saprolite unit	3 and 4	1.1 x 10 ⁻²	2.2 x 10 ⁻²	3.4 x 10 ⁻⁴	8.1 x 10 ⁻⁷	0.2 ⁽³⁾	n/a
Saprock unit	5	9.2 x 10 ⁻³	1.8 x 10 ⁻²	9.2 x 10 ⁻⁴ (2)	2.2 x 10 ⁻⁵	0.2 ⁽³⁾	n/a
Primary rock unit	6 to 17	1.0 x 10 ⁻³	2.1 x 10 ⁻³	1.0 x 10 ⁻⁴ (2)	1.2 x 10 ⁻⁷	0.1 ⁽³⁾	n/a
TSF foundation	1	1.0 x 10 ⁻⁴ (3)	1.0 x 10 ⁻⁴ (3)	5.0 x 10 ⁻⁵ (3)	2.0 x 10 ⁻⁴ (3)	0.2 ⁽³⁾	n/a

(1) Parameter K_{yy} set to equal K_{xx} in the Transported unit and double K_{xx} in the other hydrogeological units

(2) Parameter K_{zz} set to 0.1 K_{xx} based on manual calibration against piezometers installed in February 2020

(3) Parameter not calibrated by PEST

For comparison, Table 8-2 shows calibrated parameters as reported in the MOD14 assessment (Coffey, 2018a).

Table 8-2: Parameters adopted in the MOD14 assessment (provided for comparison)

Hydrogeological Unit	Hydraulic Conductivity (m/d)			Specific Storage (m ⁻¹)	Specific Yield
	K _{xx} (east-west)	K _{yy} (north-south)	K _{zz} (vertical)		
Transported unit	1.0 x 10 ⁻²	1.0 x 10 ⁻²	6.5 x 10 ⁻⁴	5 x 10 ⁻⁴	1.5 x 10 ⁻¹
Saprolite unit	1.7 x 10 ⁻²	3.4 x 10 ⁻²	1.7 x 10 ⁻²	5 x 10 ⁻⁵	1.0 x 10 ⁻⁴
Saprock unit	2.0 x 10 ⁻³	4.0 x 10 ⁻³	2.0 x 10 ⁻³	3 x 10 ⁻⁵	1.0 x 10 ⁻⁴
Primary rock unit	Varies ⁽¹⁾	Varies ⁽¹⁾	5.0 x 10 ⁻⁴	2 x 10 ⁻⁵	1.0 x 10 ⁻⁴
TSF foundation	1.0 x 10 ⁻⁴	1.0 x 10 ⁻⁴	1.0 x 10 ⁻⁴	5 x 10 ⁻⁴	1.5 x 10 ⁻¹

(1) Primary rock horizontal hydraulic conductivity reduces with depth. K_{xx} varies from 2.3x10⁻³ m/day in Layers 7 to 10, reducing approximately linearly to 5x10⁻⁴ m/day in Layers 14 to 15. K_{yy} is consistently double the value of K_{xx} in Layers 7 to 13.

Comparing the calibrated parameters for this report against the MOD14 assessment, some observations are:

- The horizontal hydraulic conductivities for the Transported and Saprock units adopted for this assessment are between 2 and 5 times the values adopted for the MOD14 assessment.
- The horizontal hydraulic conductivities for the Saprolite and Primary Rock adopted for this assessment are approximately 0.4 to 1 times the values adopted for the MOD14 assessment.
- The vertical hydraulic conductivity of the Transported unit adopted for this assessment is approximately 1.5 times the value adopted for the MOD14 assessment.

- The vertical hydraulic conductivity of the Saprolite adopted for this assessment is approximately 0.02 times the value adopted for the MOD14 assessment.
- The vertical hydraulic conductivity of the Primary rock unit in this assessment is approximately 0.2 times the value for the MOD14 assessment.
- The specific storages in the Transported and Saprock units adopted for this assessment are approximately equal to the values adopted for the MOD14 assessment.
- The specific storages in the Saprolite and Primary rock units adopted for this assessment are approximately 0.01 to 0.02 times the values adopted for the MOD14 assessment.

The differences result from the automated calibration methods adopted in this assessment, the increased data available for model development and calibration, including the gravity survey results and the pit inflow and observation well data. A key difference is the two orders of magnitude lower vertical hydraulic conductivity for the Saprolite unit resulting from the calibration for this report.

8.2.7 Assessment of calibration quality

Figures B1 to B5 in Appendix B show observed vs modelled heads at each of the 22 observation wells used for calibration and at UG-BH-01 and UG-BH-02. PDB3A, which was not used for the calibration, is included for reference. The charts show that a good fit was obtained for all of the observation wells except the following:

- PDB1A and PDB1B which may be influenced by surface water diversion pond D1, which is located in the same area, see Figure 7-2. The difference between observed and modelled heads is less than 5 m and the trend in groundwater levels is reasonably close.
- PDB5A which lies just south of the pit, shows a reasonable fit although the downward trend in the observed results is slightly higher than for the modelled results. This may be a result of localised dewatering in this area which was not captured by the model.
- MON02A and MON02B which lie at the southern edge of TSF South, show a reasonable fit although the observed upward trend in groundwater levels at these wells is slightly greater than the modelled results (reaching approximately 3.5 m difference between observed and modelled heads at MON02B at the end of the calibration period).
- The observed and modelled groundwater levels at PDB3A, from about 2013 onwards, show a difference of up to approximately 24 m. As discussed in Section 8.2.4, this is likely to be the result of localised open pit face dewatering near PDB3A which is not captured in sufficient detail by the regional scale numerical groundwater model.
- Groundwater monitoring at UG-BH-01 and UG-BH-02 commenced in February 2020. As such, it is not possible to draw conclusions about the transient calibration quality at these locations. UG-BH-01 is located very close to the model elements used to represent the excavation of the open pit, and this may influence the results. It is relevant to note, however, that the difference between modelled and observed groundwater levels in March 2020 is less than 4 m for the shallower piezometers and less than 8.5 m for the deeper piezometers.

The statistics for the calibration (as output from PEST) are:

- Correlation coefficient = 0.999
- Root mean square error (RMS) = 1.85 m
- Normalized root mean square error (NRMS) = 4.51 %
- Mean absolute error (MAE) = 1.36 m

The above NRMS value of 4.51 % indicates the quality of the calibration is very good, considering the conceptual model is based on site geological conditions and is not chosen solely in order to improve the calibration fit near observation wells.

Figure 8-15 shows the observed versus modelled groundwater head at each of the observation wells used in the calibration for the period 2005 to 2020, excluding UG-BH-01 and UG-BH-02.

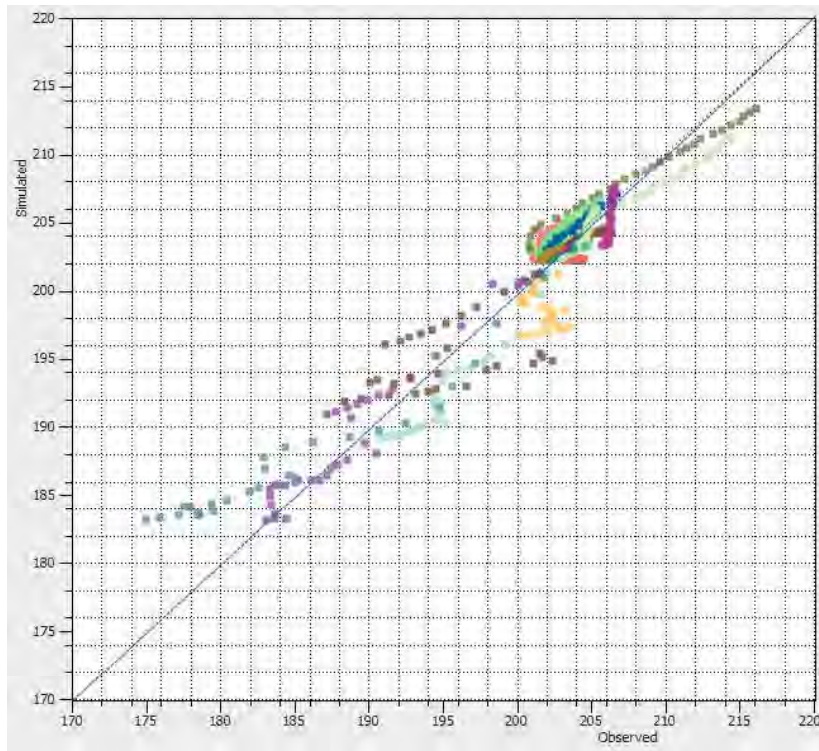

Figure 8-15: Observed versus modelled groundwater head

The Australian Groundwater Modelling Guidelines (Barnett et al, 2012) provide discussion on quantitative measures for assessing calibration quality. These are based on the RMS or the NRMS (called the Scaled RMS in the guidelines). The guidelines do not set quantitative targets that must be achieved, as a target of 5 % NRMSE for example, may not be achievable with all models.

The model mass balance error is generally below, or very close to 1 % from 2005 to 2050. This is the period where groundwater stresses related to open pit excavation and underground mining occur. The mass balance error increases slightly beyond 2050. This is thought to be a result of the adaptive time stepping procedure adopted in the model, which increases when model stresses are small. It can be seen from Figure 10-5 that there is some minor oscillation in the predicted inflow beyond about 2050 however the oscillations are about an average rate and do not increase beyond reasonable bounds. Figure 8-16 shows the model mass balance error percentage at select times.

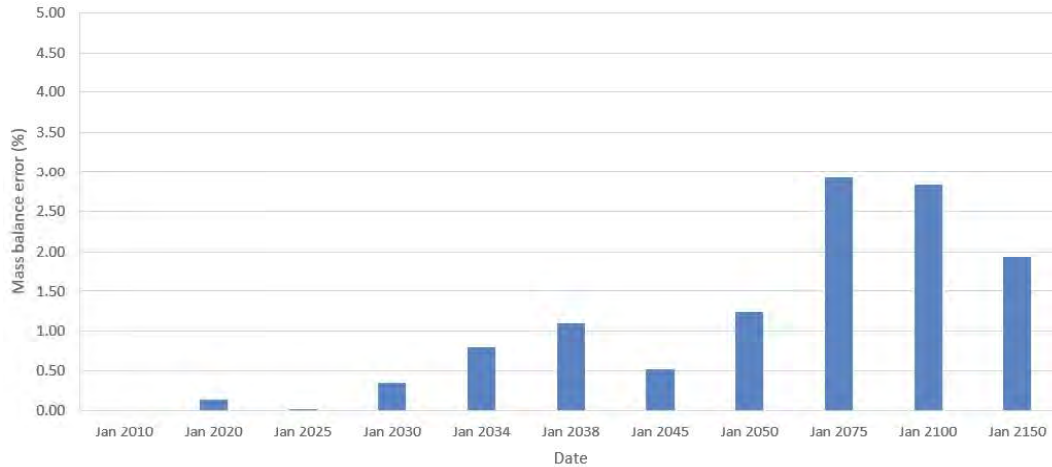

Figure 8-16: Model mass balance error (%) at selected times

8.2.8 Parameter sensitivities

Parameter sensitivities were provided by PEST as part of the model calibration. The relative sensitivity of the calibration to the main parameters in each of the hydrogeological units is shown in Figure 8-17.

The figure shows that the model calibration is approximately equally sensitive to the parameters used in the calibration, with the highest sensitivity being 0.225 to the vertical hydraulic conductivity of the Transported unit and the lowest sensitivity being 0.175 to the horizontal hydraulic conductivity of the Saprock unit.

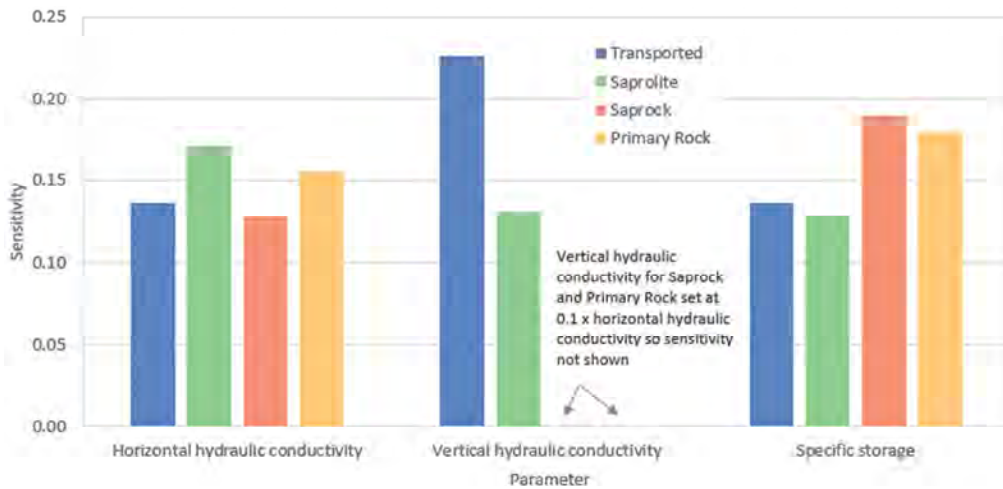

Figure 8-17: Relative sensitivity of the model calibration to parameters

8.2.9 Comparison of model with measured pit dewatering rates

Open pit dewatering rates have been provided by Evolution Mining. The provided dewatering rates are highly variable and not well correlated with rainfall, as shown in Figure 8-18. There is some uncertainty in the estimate of groundwater inflow to the open pit based on the provided pit dewatering volumes. During drier periods, such as those shown circled in Figure 8-18, the effects of surface runoff and/or rainfall are likely to be less pronounced and a better estimate can be obtained.

Rainfall inflow has been assessed based on the pit footprint and the effective rainfall and allowing for pan evaporation occurring over 10% of the pit footprint. Effective rainfall has been taken as 75% of daily rainfall above 5 mm. Rainfall is for West Wyalong Post Office (Bureau of Meteorology Station 73054) which shows a good correlation with rainfall at the mine site (Coffey, 2018b).

Modelled groundwater inflow to the open pit output from the numerical model is plotted in Figure 8-18. The modelled groundwater inflow, compared to the measured pit dewatering during dry periods (circled) shows a reasonable fit, particularly in 2007 to 2009, 2011, late 2015 and 2017 to mid-2019. It can be observed that the corrected pit dewatering rates are close to the modelled groundwater inflow during approximately the same periods, except for late 2012 and late 2014.

Evolution Mining staff estimate that during 2019, the rate of groundwater inflow to the open pit was approximately 1,000m³/day. The calibrated model agrees well with this inflow rate, with modelled groundwater inflow rates to the open pit of approximately 950 m³/day during 2019.

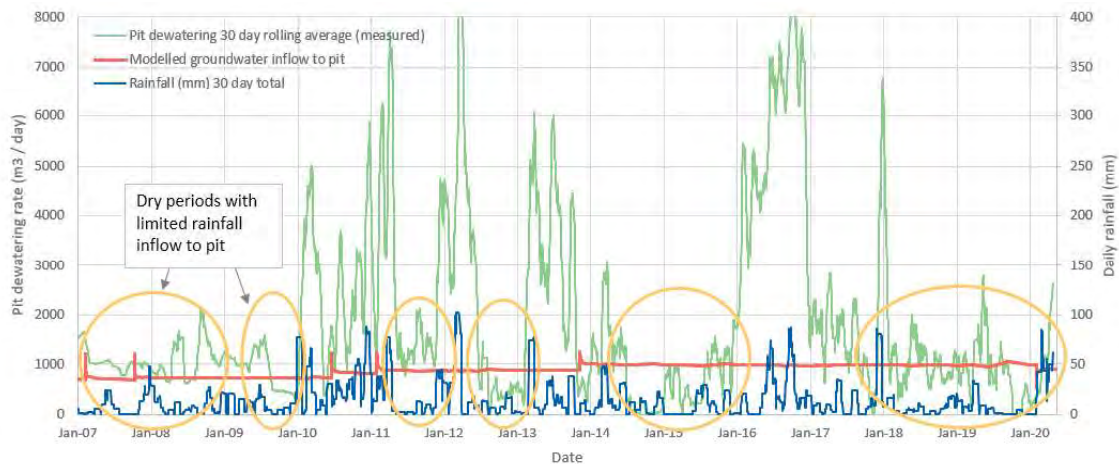

Figure 8-18: Pit dewatering and rainfall

8.3 Uncertainty assessment

The calibration process described above used PEST to find a set of parameters which provided a good match between field observations and model results. This was done by the minimisation of the 'objective function' which is the sum of squared differences between field observations and model results. With 16 parameters being calibrated (hydraulic conductivities and specific storages) not including the rainfall infiltration, it is probable there are a number of parameter combinations which result in an objective function small enough for the resulting model to be considered as calibrated. This is known as model parameter uncertainty.

The model parameters were also calibrated to observed open pit inflows as discussed in Section 8.2.5. It is clear from Figure 8-18 that there is uncertainty in the observed rate of groundwater inflow into the open pit. This rate could conceivably be adopted as anywhere between 750 m³/d and 1,100 m³/d from January 2018 to July 2019. This is an example of observation uncertainty.

A quantitative assessment of model parameter uncertainty was carried out using PEST. In this process, PEST completed a large number of model runs (690 runs) to find alternative calibrated

model parameter sets, the results of which provide an envelope of the range of probable values to particular model results as defined by the user.

PEST was directed to select the four resulting model parameter sets which provided the following maximum and minimum values for groundwater head and inflow to the open pit:

- Parameter set 1: Maximum inflow to the open pit on 1 Jan 2020.
- Parameter set 2: Minimum inflow to the open pit on 1 Jan 2020.
- Parameter set 3: Maximum groundwater head at the location of UG-BH-02 (SG3) at 1 Jan 2020.
- Parameter set 4: Minimum groundwater head at the location of UG-BH-02 (SG3) at 1 Jan 2020.

For each of the cases run by PEST, a condition was imposed that the objective function was allowed to be at most 5% greater than the minimum objective function found in the calibration process described above. This ensured that the resulting model parameter sets were calibrated to the observation data. A total of 690 model runs were completed by PEST during the search for the four model parameter sets which provided the four limiting model results described above. The parameter set with the required maximum or minimum value was selected by PEST for each of the four specified cases.

As discussed in Section 8.2.5, observed inflow rates to the open pit between January 2018 and January 2020 are less influenced by rainfall or other external factors compared to other periods. To incorporate the observed open pit inflows into each of the four model parameter sets, the hydraulic conductivity, specific storage and rainfall recharge parameters for each parameter set was scaled by the same amount required to provide a reasonable match to observed inflow rates to the open pit for the period January 2018 to January 2020. As discussed in Section 8.2.5, this does not affect the calibration of the parameter set to observed groundwater heads.

Table 8-3 shows the objective function and the resulting modelled inflow and groundwater head values at 1 Jan 2020, prior to scaling the results to match actual open pit inflows at 1 Jan 2020. Note that parameter Set 2 turned out to be the same as the calibrated parameter set shown in Table 8-1, which are our adopted model parameters.

Table 8-3: Details of model uncertainty targets, resulting objective functions and model results

Parameter set	Target	Objective function	Model results ⁽¹⁾ (prior to scaling to observed pit inflows)	
			Pit inflow (m ³ /d)	Groundwater head (m AHD) at UG-BH-02 (SG3)
Set 1	Maximum inflow	2083	1750	191.8
Set 2 (adopted)	Minimum inflow	2033	966	192.8
Set 3 ⁽²⁾	Maximum head	2060	815	197.6
Set 4	Minimum head	2052	1112	192.6

(1) These results are part of the uncertainty assessment and are not model predictions. Model predictions are discussed in Section 10

(2) Parameter K_{zz} not tied to K_{xx} for Saprock and Primary Rock for this set

Note that Set 3, resulting from the assessment targeting maximum head, actually resulted in a lower open pit inflow than Set 1, which targeted minimum inflow. This is likely a result of the vertical

hydraulic conductivities for the Saprock and Primary Rock not being tied to the horizontal hydraulic conductivities in the assessment for maximum head. In addition, the PEST process is not guaranteed to find the absolute maximums and minimums of the target criteria in each of the assessments.

The resulting parameters are shown graphically in Figure 8-19. The vertical and horizontal hydraulic conductivities are all relatively close, being within approximately a factor of two from one another for each of the hydrogeological units. One exception is the vertical hydraulic conductivity in the Primary Rock unit for Set 3, which is approximately five times greater than the value for the other units. This is to some extent balanced by the lower horizontal hydraulic conductivity for the Primary Rock unit in Set 3. This is likely a result of the vertical hydraulic conductivities for the Saprock and Primary Rock not being tied to the horizontal hydraulic conductivities in the assessment for maximum head. The targeting of maximum head at UG-BH-02 (SG3) for Set 3 results in an improved calibration at that location and hence the tying of those parameters is not required.

The four sets of model parameters were used to assess predicted inflows to the open pit, stopes and access tunnels from 2021 to 2039 and to assess groundwater table drawdowns at 2038. Open pit inflow observational uncertainty was incorporated into the inflow uncertainty assessments as discussed in Section 10.3. Whilst the parameters for the different sets are all relatively close to one another, the resulting predicted inflows differ significantly. Predictive model results are discussed further in Section 10.

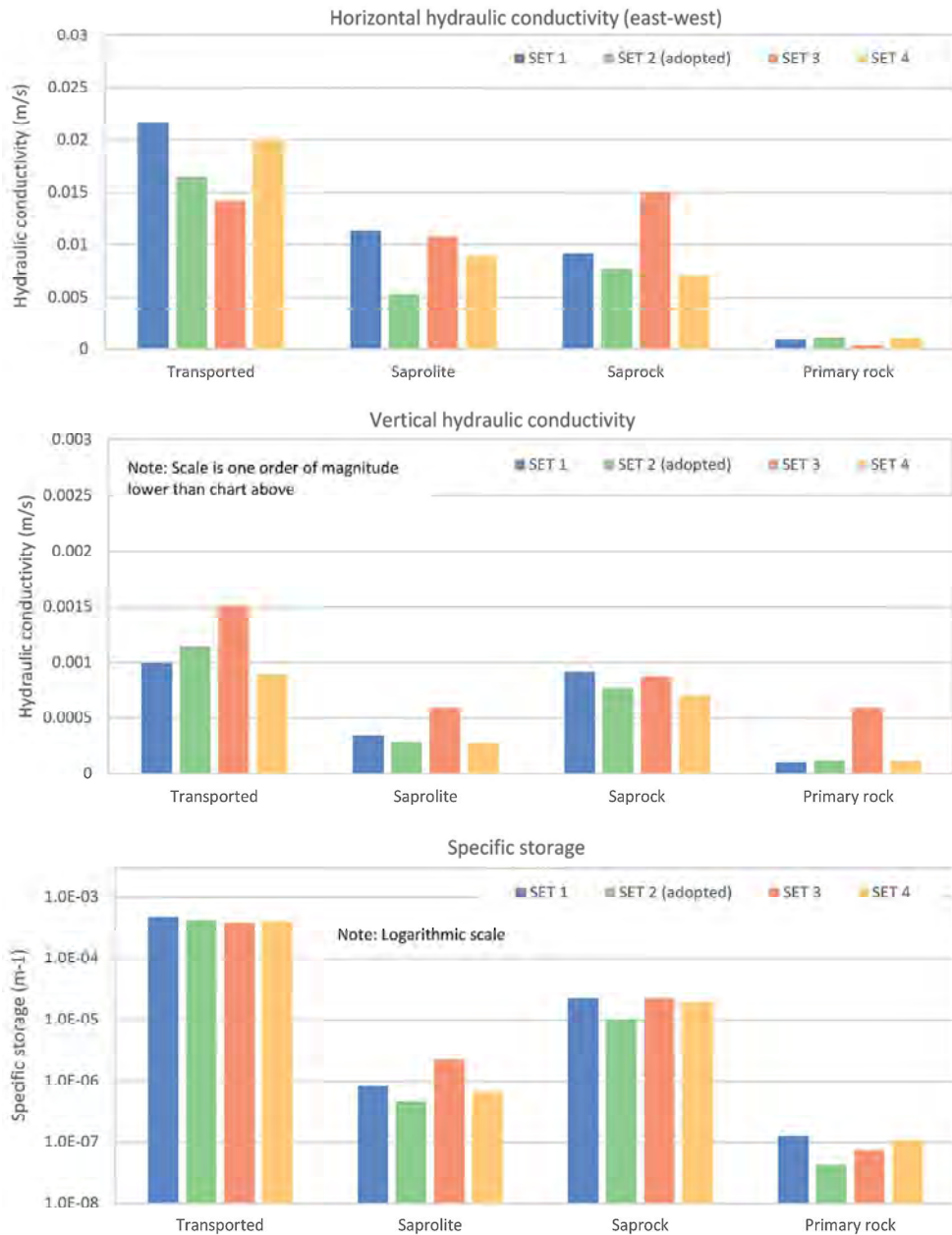

Figure 8-19: Alternative sets of calibrated model parameters

8.4 Model classification

The Australian Groundwater Modelling Guidelines (Barnett et al, 2012) provide discussion on confidence level classifications for numerical groundwater models. The model described in this report is considered to meet the criteria for Class 2, and a number of aspects of Class 3. A summary of the key indicators is provided below:

- A conceptual model has been developed which incorporates the principal hydrogeological units and the main sources of groundwater recharge and discharge in the area covered by the model.

- The model is based on geological exploration borehole records and groundwater monitoring and testing in and around the model domain, in particular on mining lease ML1513. These include investigations carried out in the area above the proposed underground mine in 2020 which are included in this report as Appendix E.
- The model was calibrated against 22 piezometers with monitoring data for the period 1 Jan 2004 to 1 Jan 2020, and open pit dewatering records for the period 1 Jan 2005 to 1 Jan 2020.
- The calibration statistics provide a NRMSE of 4.51% which indicates a good match between observations and model results.
- A quantitative model parameter uncertainty analysis has been carried out using the open source software PEST. Consideration of observational uncertainty related to open pit dewatering records has been incorporated in predictive results.
- The model is used to predict impacts to groundwater levels and the groundwater flow regime during the life of the proposed underground mine (2020 to 2040) and the post mining recovery period. The predictive period of underground mining and first 20 years of post-mining recovery (2020 to 2060) is less than three times the timeframe used for calibration.
- The groundwater stresses for the predictive modelling period are similar to those for the calibration period.
- The time discretisation for the predictive modelling period as that for the calibration period. This uses an adaptive time step procedure, as implemented in Feflow Version 7.2.
- The model mass balance error is generally below, or very close to 1 % from 2005 to 2050, as shown in Figure 8-16. This is the period where open pit excavation, underground mining and groundwater recovery in paste backfilled stopes is modelled.

9 Predictive modelling

Predictive modelling was undertaken to assess groundwater impacts to Lake Cowal and the area surrounding the mine and to assess inflow rates into the open pit, stopes and access tunnels. In addition, the predictive model was used to assess contaminant transport in groundwater originating from beneath the IWL post mining.

In order to include the stopes in the model mesh, the stopes were represented by simplified polygons at each model vertical layer, as shown in Figure 8-2 and Figure 8-3. This is considered reasonable since groundwater heads at a small distance from the stopes will be smoothed out so as to no longer show the finer details of the stopes and will match groundwater heads from a model where the stopes are represented as a much simpler polygon. To test this expectation, Figure 9-1 was set up in Seep/W. The figure shows steady-state groundwater head contours are smoothed out even at very close distances to a complicated fixed head boundary. This is a result of the governing physics of groundwater flow, where groundwater naturally flows to smooth out differences in hydraulic head.

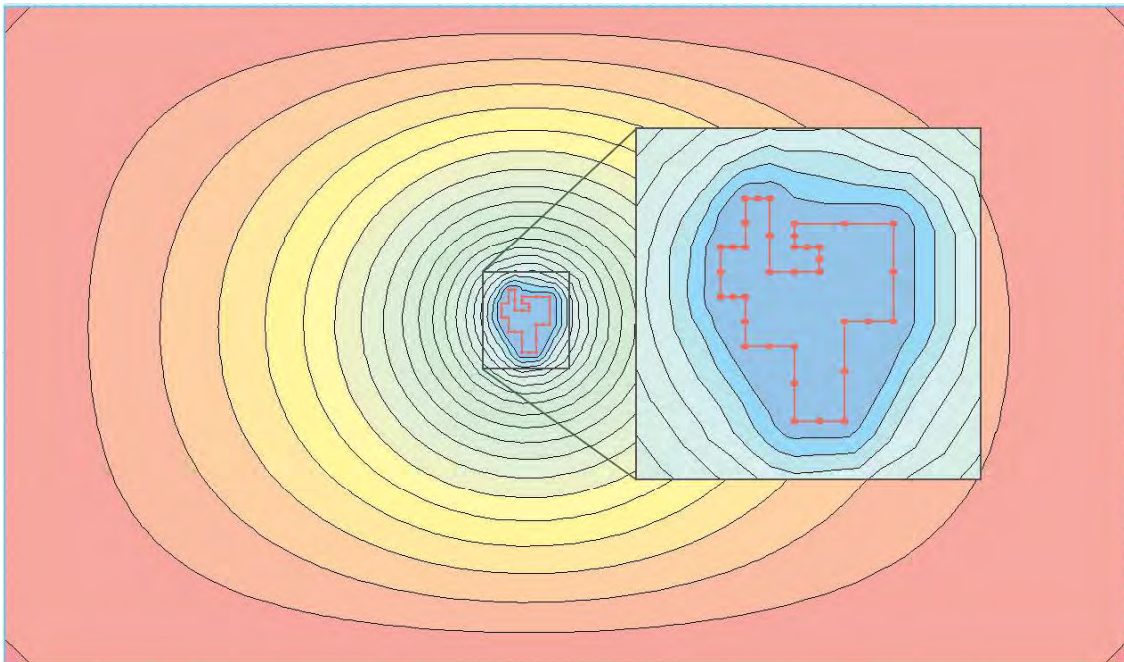

Figure 9-1: Example showing contours of groundwater head are smoothed out only a short distance away from a complicated structure where a fixed head is applied (Image created using Seep/W)

9.1 Representation of future mining activities

9.1.1 Open Pit

The excavation of the open pit was represented by applying time varying fixed head boundary conditions to the base of the pit and seepage face boundary conditions to the walls. As the pit excavation progressed, blocks of the model were deactivated to represent the pit void and seepage face boundary conditions applied, as discussed in Section 8.1.2.

Following the end of mining and dewatering of the open pit, groundwater inflow and surface water run-off will gradually fill the base of the open pit, forming a lake. The pit lake water level will rise to a level where net evaporation from the pit lake is balanced by groundwater inflow and surface water run-off into the pit.

The pit lake water level post mining is highly dependent on the surface water regime surrounding the open pit. A preliminary assessment of water level recovery and groundwater inflow to the open pit after the end of mining was carried out by:

- Assuming the pit void to be a conical volume with an upper diameter 1070 m at an elevation of 204 m AHD and a lower diameter of 340 m at an elevation of -225 m, based on pit shell designs provided by Evolution.
- Assuming rainfall inflow of 450 mm to the open pit from a 1,250 m diameter circular catchment.
- Assuming pan evaporation from the surface of the pit lake, the surface area of which was assumed to be circular with diameter dependent on the elevation of the pit lake and the assumed conical volume of the open pit void described above. An average annual evaporation rate of 70 % x 1,800 mm (1,260 mm) was assumed.
- The modelled rate of groundwater inflow to the open pit, which is dependent on the elevation of the pit lake level, was added to the net inflow to the pit lake from evaporation and rainfall.

This was carried out through an iterative process whereby a pit lake elevation timeseries was incorporated into the numerical model as fixed head boundary conditions at the edges of the open pit void. This resulted in a timeseries of groundwater inflow to the open pit, which was then used to update the pit lake elevation timeseries externally. The process was repeated until a reasonable agreement was found between the modelled groundwater inflow to the open pit at successive iterations.

The resulting groundwater inflows to the open pit post mining were provided to the surface water engineers who incorporated them in their assessment of the predicted pit lake level post mining. Following a small number of iterations with the surface water engineers, a reasonable agreement was achieved between the groundwater and surface water models.

The resulting groundwater head at the base of the open pit during mining and recovery is shown in Figure 9-2.

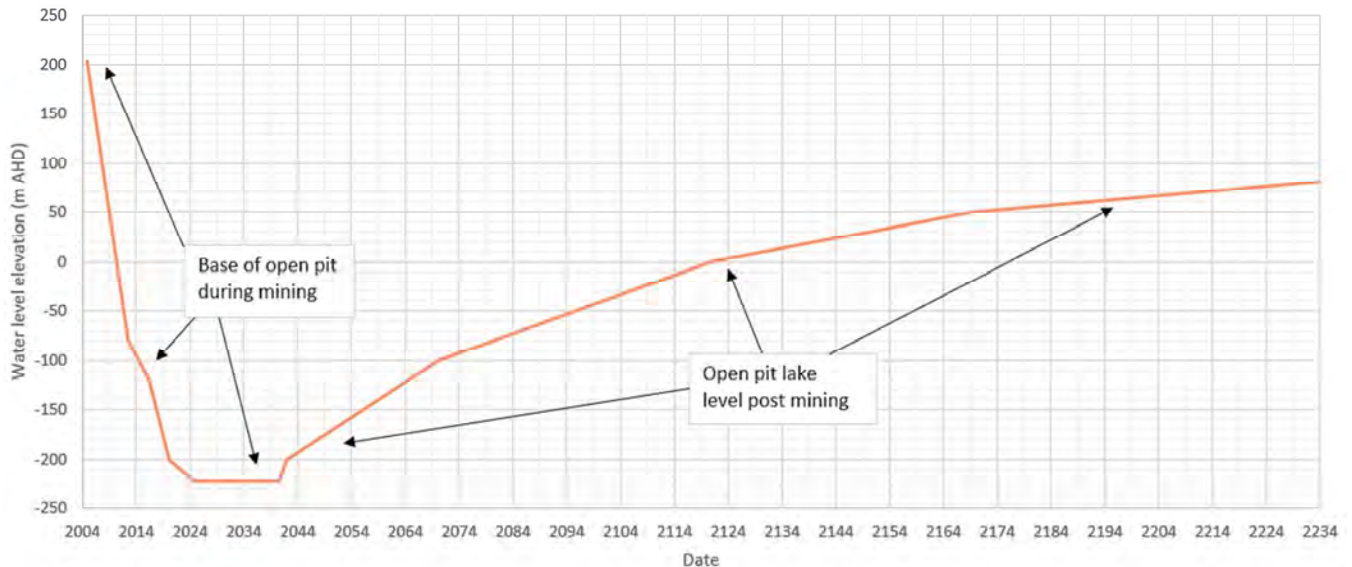

Figure 9-2: Modelled groundwater head at base of open pit

9.1.2 Open pit dewatering bores and horizontal drains

Open pit dewatering bores and horizontal drains were modelled for the period February 2011 to January 2020, as discussed in Section 8.1.2.

Dewatering bores and horizontal drains were not modelled beyond 2020.

The effects of dewatering bores and horizontal drains are local in nature and have a similar effect to the model as the outline of the open pit extending slightly outwards. The predictive modelling, with no observations to calibrate against, does not aim to achieve this level of detail or accuracy.

9.1.3 ML1535 saline groundwater supply bores

The ML1535 saline groundwater supply bores were not modelled. As indicated in the MOD14 assessment (Coffey, 2018a), the predicted groundwater drawdown due to groundwater extraction from the ML1535 saline groundwater supply bores is insignificant relative to the groundwater drawdown induced by the open pit.

9.1.4 Tailings Storage Facilities and Integrated Waste Landform

Section 7.4 provides the historical and proposed water levels for the TSF and IWL. The modelled groundwater levels were taken as equal to the crest levels shown in Figure 9-3. Groundwater fixed head conditions are applied only during the active stages of the TSF / IWL, as indicated by solid lines in the figure.

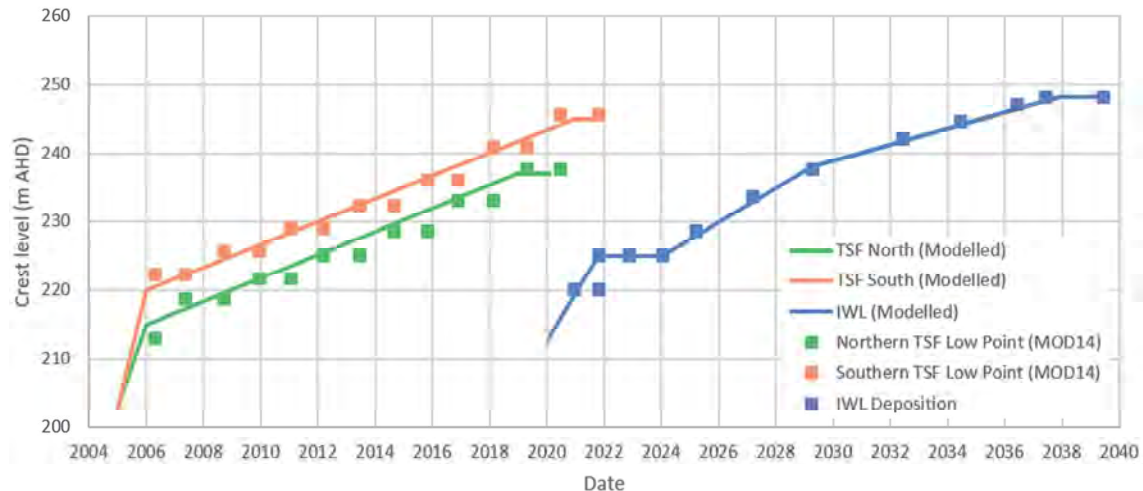

Figure 9-3: Modelled TSF and IWL crest levels

9.1.5 Lake Cowal

Time varying fixed heads were applied to the nodes on the surface at the area of Lake Cowal as discussed in Section 8.1.2 and shown in Figure 8-13 for the period 1998 to 2020.

For the period beyond 2020, two scenarios were modelled:

- A dry lake scenario where the groundwater head for the nodes representing Lake Cowal was set at 201.5 m AHD.

- A flooded lake scenario where the groundwater head for the nodes representing Lake Cowal was set at 206 m AHD.

Model results showed that the two scenarios were practically indistinguishable in terms of the predictive model results for groundwater levels, drawdowns and inflows. As such, figures and charts for the flooded lake scenario are not included in this report.

9.1.6 Stopes and tunnels

The geometry of the proposed stopes and access and haulage tunnels were provided by Evolution. This data was extracted and converted to suitable file formats for input into the numerical model using Coffey's in-house software. A reasonable balance between an accurate representation of geometry and the complexity of the numerical model is a key consideration when representing geometry in a numerical model.

9.1.6.1 Excavation sequence

For the numerical model, the access tunnels have been split into the five areas shown in Figure 9-4.

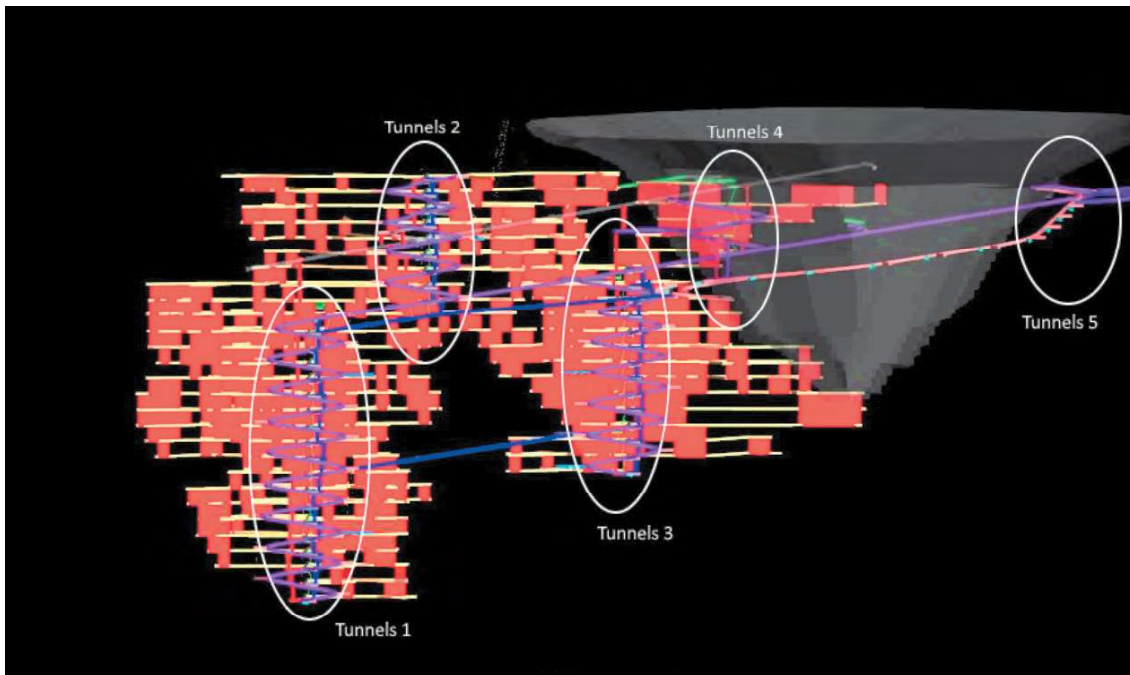

Figure 9-4: Access tunnel areas

Based on the excavation sequence provided by Evolution, which is shown in Figure 7-9, the times shown in Table 9-1 were used to model the stopes and access tunnel excavation sequence.

When the stoping reaches a particular layer, the stopes elements for that layer are deactivated, forming a void, and seepage face boundary conditions are applied so that groundwater flows out of the model and into the void. Due to the relatively high hydraulic conductivity of the paste backfill, as discussed below, the backfilled stopes can be considered as equivalent to a void during mining from a groundwater inflow perspective. For this reason, in the model the stopes voids and seepage face boundary conditions are active from their date of excavation until the end of mining. After the end of mining the recovery of groundwater is modelled by considering the storage within the access tunnels and the residual storage remaining within the stopes filled with paste backfill.

Individual stopes were not modelled. From consideration of scheduling animations provided by Evolution, a representative time of commencement of stoping at each horizontal layer was selected. All stopes elements and boundary conditions for that layer were activated in the model at that time.

When the access tunnels reach a particular layer, seepage face nodes are applied to the nodes representing those tunnels in that layer, allowing groundwater to flow out of the model. Tunnel seepage face nodes are active from the time tunnel development reaches a particular layer elevation until the end of underground mining.

The access tunnel voids were not represented explicitly in the model. Their influence is considered to be captured by modelling of the stopes. The computational time associated with a model mesh fine enough to capture each individual tunnel was deemed to be prohibitive for the purposes of the model, which are to provide a regional scale assessment of impacts groundwater levels and flow regimes.

Table 9-1: Stopes and tunnels excavation sequence (tunnel areas refer to Figure 9-4)

Model layer	Base of layer elevation (m AHD)	Date stoping reaches model layer elevation	Date Tunnels 1 reaches model layer elevation	Date Tunnels 2 reaches model layer elevation	Date Tunnels 3 reaches model layer elevation	Date Tunnels 4 reaches model layer elevation	Date Tunnels 5 reaches model layer elevation
L7	50			01-Jan-24		01-Jan-22	01-Jan-23
L8	0	01-Jan-24		01-Jan-24		01-Jan-22	
L9	-100	01-Jan-25		01-Jan-24		01-Jan-22	
L10	-200	01-Jan-26	01-Jan-25		01-Jan-23		
L11	-300	01-Jan-27	01-Jan-26		01-Jan-26		
L12	-400	01-Jan-29	01-Jan-27		01-Jan-27		
L13	-500	01-Jan-31	01-Jan-29		01-Jan-29		
L14	-600	01-Jan-32	01-Jan-30				
L15	-700	01-Jan-33	01-Jan-31				

9.1.7 Paste backfill

The stopes will be filled progressively with paste backfill to provide support. This will influence the timing of recovery of groundwater levels following mine closure.

The paste backfill pre-feasibility study report (Outotec, 2020) was reviewed. A representative hydraulic conductivity of 39 mm/hr (1.1×10^{-5} m/s) for the paste backfill was quoted in that report. This hydraulic conductivity is at least two orders of magnitude greater than that of the surrounding rock based on calibration of the numerical model to piezometers in ML1535.

Due to the relatively high hydraulic conductivity of the paste backfill compared to the surrounding rock, the backfilled stopes can be considered as equivalent to a void during mining from a groundwater inflow perspective.

9.1.8 Groundwater recovery in stopes and access tunnels

Following the end of ore processing, the groundwater levels in the stopes and access tunnels will recover. Air voids or fillable porosity in the paste backfill will fill with groundwater. In addition, the whole volume of the access tunnels with elevations below the outlet to the open pit will fill with

groundwater. This process was represented in the numerical model by a modification to the specific storage parameter for the paste backfill.

Based on the provided total mass of extracted ore and length of access tunnels, as provided by Evolution, the following volumes were assessed, assuming an ore unit weight of 24 kN/m² and an average tunnel diameter of 6.5 m:

- Total stopes volume: 64,739,000 m³
- Total access tunnels volume: 1,326,000 m³

Assuming a fillable porosity of 0.1 in the paste backfill at the end of ore processing / start of groundwater recovery, and including the entire access tunnels volume, the total volume to be filled by groundwater during recovery is 7,800,000 m³. Based on observation of model results, this volume will be filled as the groundwater head rises from approximately -300 m AHD to 120 m AHD. This results in a specific storage of:

$$\frac{(\text{Volume of groundwater absorbed})}{(\text{Total volume of stopes and tunnels}) \times (\text{change in head})} = 2.8 * 10^{-4} / \text{m}$$

This specific storage parameter was adopted for the paste backfill from the end of ore processing to the end of model time.

10 Predictive modelling results

Figures C1 to C8 in Appendix C provide modelled groundwater head contours at January 2020, January 2038, January 2058 and January 2158. These dates represent approximately the time prior to underground development, just prior to the end of underground mining, and approximately 20 years and 100 years post mining, respectively.

Figures C9 and C10 in Appendix C provide modelled groundwater table drawdown contours at January 2020, January 2038, January 2058 and January 2158. These drawdowns are the predicted change in groundwater table elevation since January 2004.

Figure C11 provides modelled 5 m drawdown and mounding contours for each of the four parameter sets in the uncertainty assessment described in Section 8.3.

10.1 Groundwater levels during mining

The figures below show model results at January 2020, January 2038, January 2058 and January 2158. These dates represent approximately the time prior to underground development, just prior to the end of underground mining, and approximately 20 years and 100 years post mining, respectively.

The groundwater heads in the Transported, Saprolite, Saprock and Primary Rock units can all be seen to decrease between 2020 and 2038.

Groundwater head contours in the Transported, Saprolite and Saprock units near the open pit, stopes and access tunnels show a decrease of approximately 5 m between 2020 and 2038. The influence of the underground development on groundwater levels in these units appears to be very small to negligible with only a slight shift apparent in the centre of the groundwater contours towards the location of the underground development at 2038.

Groundwater head contours in the Primary Rock unit at 0 m AHD show a decrease of 80 m in the area above the stopes and access tunnels between 2020 and 2038. This elevation is close to the top of the stopes and access tunnels and the effects of the underground mine can be seen more clearly here.

The drawdown of the groundwater table caused by the open pit, stopes and access tunnels can be seen to lie entirely within ML1535 during and until the end of mining in 2038 except for small areas to the north and south where the 1 m drawdown contour is just outside the mining lease.

Mounding of the groundwater table caused by the IWL is predicted to extend outside the ML 1535, predominantly to the south west.

Figure 10-1, Figure 10-2 and Figure 10-3 show the modelled groundwater table drawdown at January 2020, January 2038 and January 2058, respectively. These drawdowns are the predicted change in groundwater table elevation since January 2004.

Figure 10-4 shows the predicted 5 m groundwater table drawdown and mounding contours in 2038, for the four parameter sets considered in the uncertainty assessment in Section 8.3. The 5 m drawdown contours for Set 1, Set 2 and Set 4 are relatively close, each being within about 200 m from one another. The 5 m drawdown contour for parameter Set 4 extends a further 700 m out to the north east compared to the other sets. This is the result of a higher vertical hydraulic conductivity assigned to the Primary Rock for Set 3, as shown in Figure 8-19. For all parameter sets, the 5 m drawdown contour is predicted to lie within ML1535 in 2038.

The effect on the predicted groundwater table from the underground development only, compared to the currently approved mine plan with no underground development, can be assessed by observing in Figure 10-2 that the groundwater table drawdown contours in 2038 show a very small, barely perceptible elongation over the area of the proposed underground development. In Figure 10-3, the 5 m groundwater table contour in 2058 extends approximately 300 m further out to the north than

where it would be considering the concentric ellipses around the open pit, which are indicative of the effects of the currently approved (open pit) mine plan only.

A similar consideration of the groundwater head contours shown in Figures C1 to C8 in Appendix C, indicate that the effects of the underground development only on the predicted groundwater heads in the Transported, Saprolite and Saprock units appears to be negligible. The effects on the groundwater heads in the Primary Rock unit are more apparent. This can be observed in Figure C7 in Appendix C, which shows the centre of the groundwater head contours shifting away from the open pit towards the area of the underground development during the operation of the underground mine.

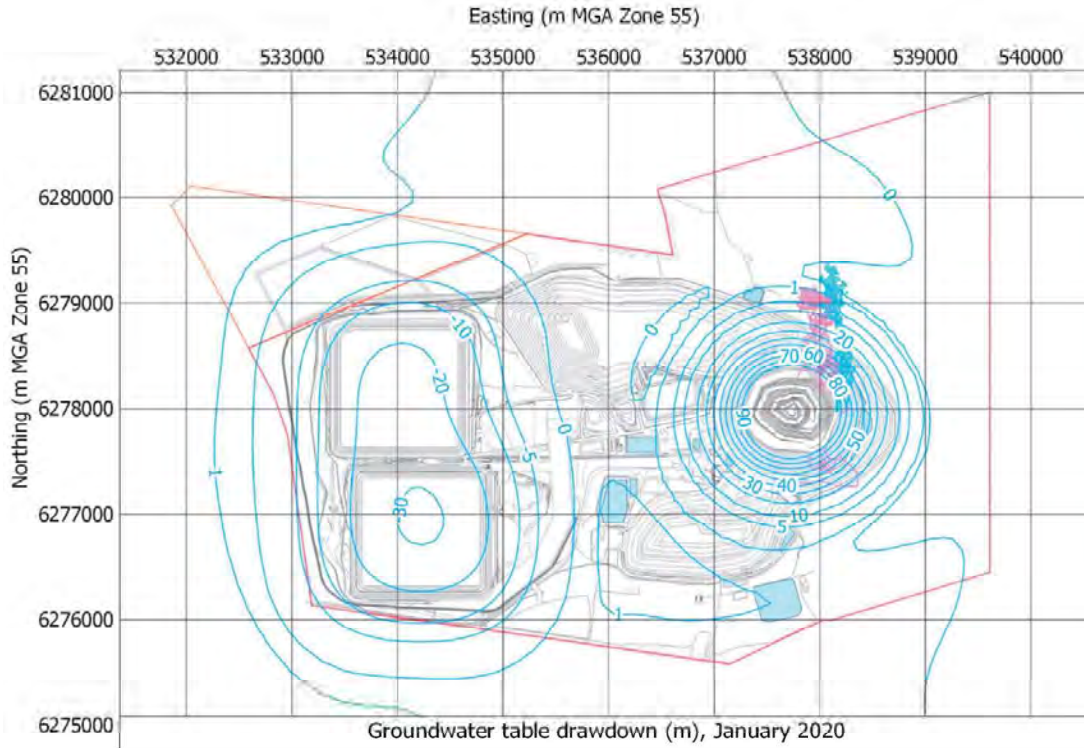

Figure 10-1: Modelled groundwater table drawdown from 2004 to 2020

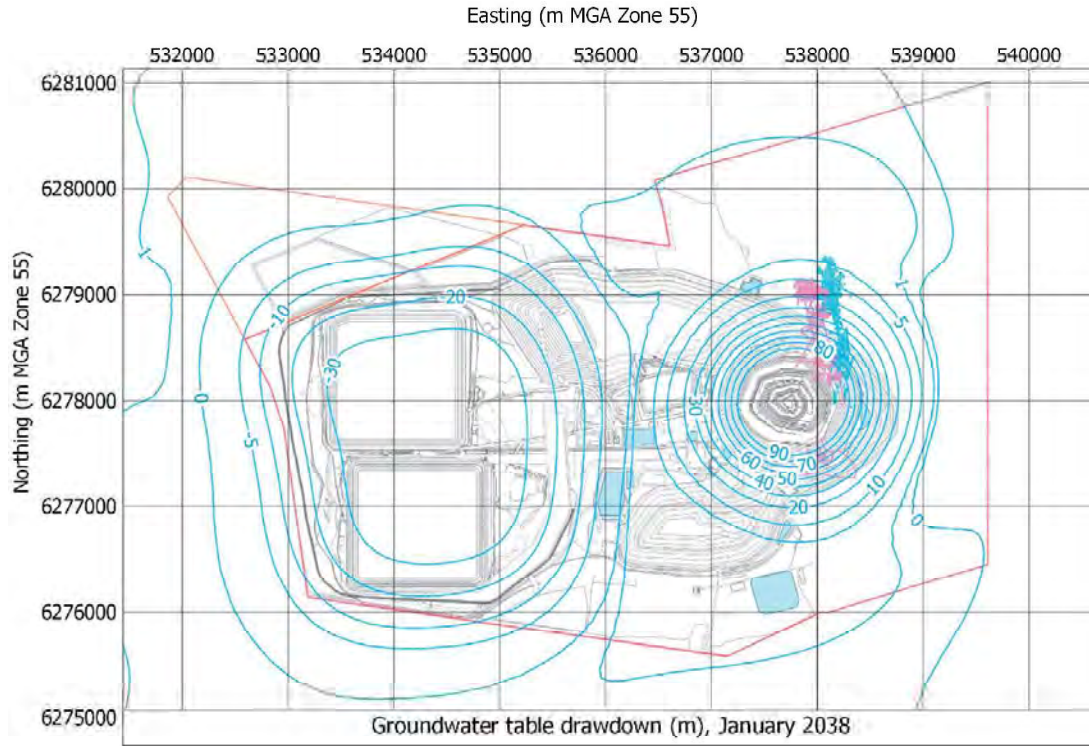

Figure 10-2: Modelled groundwater table drawdown from 2004 to 2038

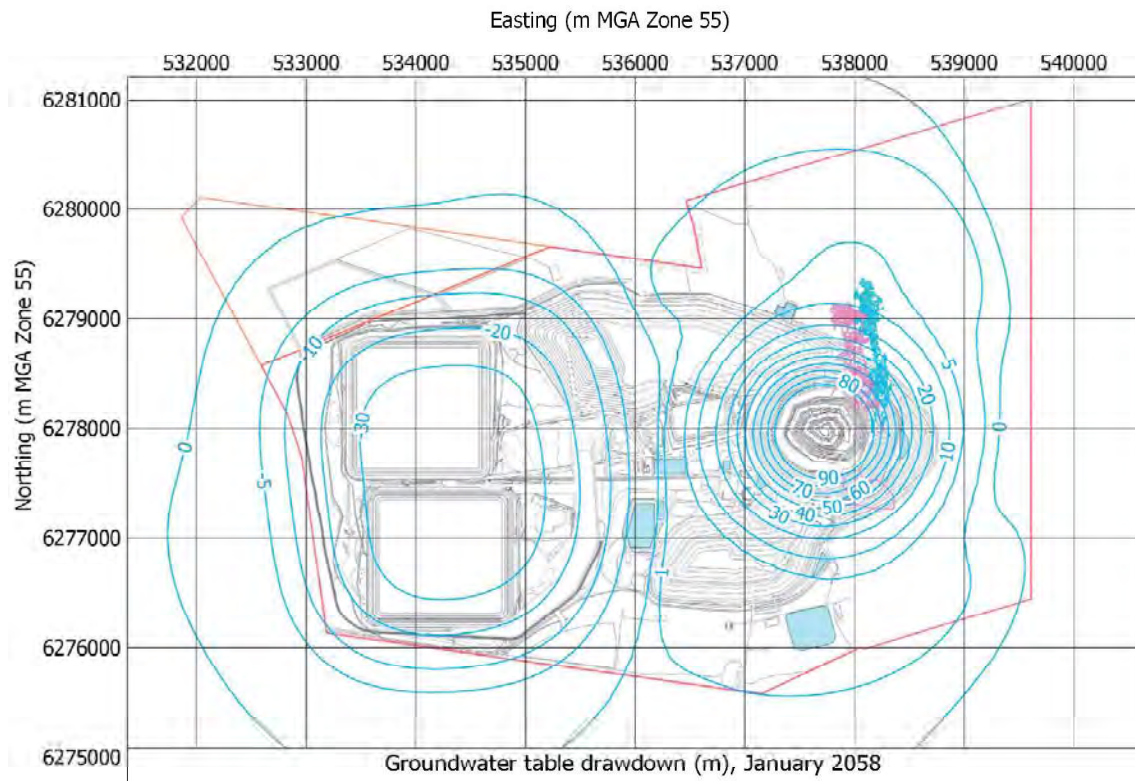

Figure 10-3: Modelled groundwater table drawdown from 2004 to 2058

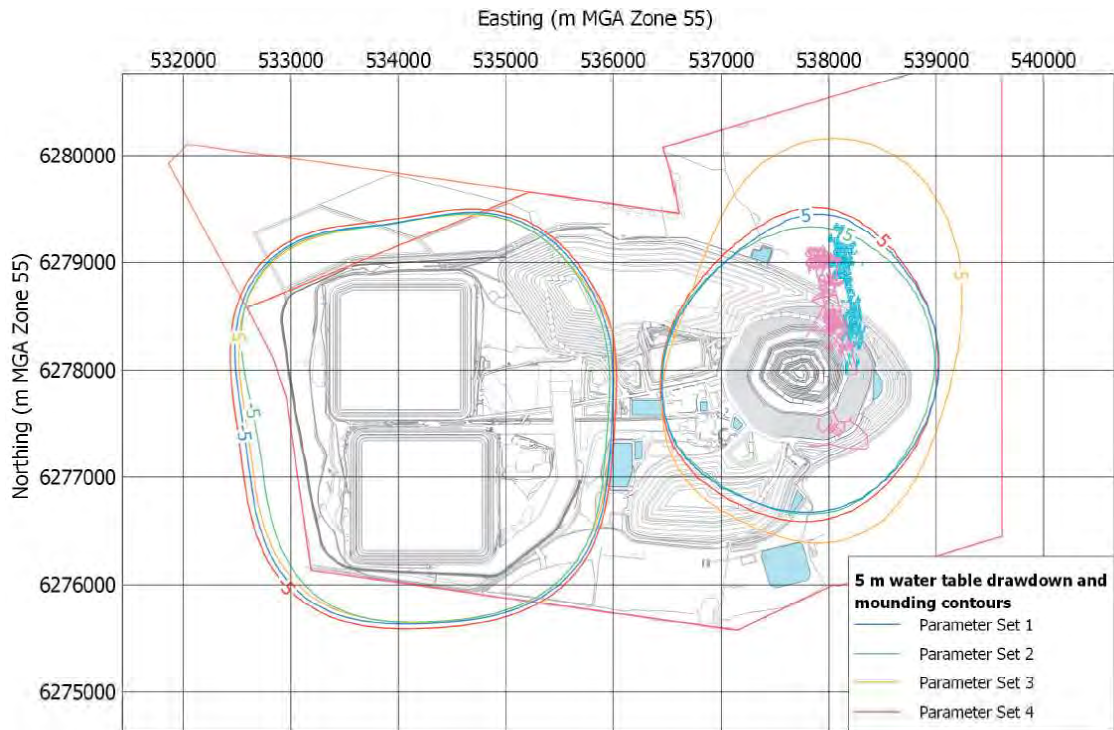

Figure 10-4: Uncertainty in modelled groundwater table drawdown at January 2038

10.2 Groundwater levels post mine closure

Following the end of mining in mid-2039, groundwater will continue to flow into the open pit and gradually increase the water level in the open pit. Figure 9-2 shows the modelled water level in the open pit following the end of mining. This was derived based on predicted inflows to the open pit and on provided open pit shell geometry, as discussed in Section 9.1.1.

As the water level in the open pit will remain below the surrounding groundwater level (assuming the open pit is not flooded with surface water), groundwater surrounding the open pit will continue to flow towards the open pit indefinitely in the absence of any other external factors.

Figures C3 to C8 in Appendix C show that there is predicted to be a slight recovery in groundwater heads around the open pit in the Transported, Saprolite and Saprock units of around 5 m between 2038 and 2058 and then a negligible change between 2058 and 2138. The figures show the recovery of groundwater heads in the Primary Rock unit between 2036 and 2138 is more pronounced. This is related to recovery of drawdown associated with the stopes and also the infilling of the base of the pit with groundwater inflow.

10.3 Groundwater inflows during mining

Based on our adopted model parameters, combined groundwater inflow to the open pit and the stopes is predicted to increase from approximately 1,000 m³/day in 2020 to a peak of approximately 2,800 m³/day in 2031 and continue at this rate until the end of mining and ore processing.

Based on the currently approved mine plan with no underground development, groundwater inflow to the open pit is predicted to remain approximately constant at 1,000 m³/day from 2020 to the end of ore processing, and then gradually reduce as the pit lake fills. The additional groundwater inflow resulting from the proposed underground development is predicted to increase from zero at the

commencement of the underground development in 2022 to a peak of approximately 1,800 m³/day in 2031 and then continue at this rate until the end of mining in mid-2039.

A model parameter uncertainty assessment was carried out to assess different parameter sets which are calibrated to field observations, as described in Section 8.3. This resulted in four sets of calibrated model parameters which were used to provide four equally probable estimates of groundwater inflow to the open pit, stopes and access tunnels from 2022 to 2039.

Uncertainty in the observed rate of groundwater inflow to the open pit was incorporated by allowing for a possible range in the observed rate of groundwater inflow to the open pit of between 750 m³/day and 1,100 m³/day for the period January 2018 to January 2020, refer to Figure 8-18. Recall from Section 8.2.5, the observed inflow to the open pit was incorporated into the model calibration by scaling the hydraulic conductivity, specific storage and rainfall recharge parameters by the same amount required to provide a reasonable match to observed inflow rates to the open pit for the period January 2018 to January 2020. This scaling has the effect of changing the modelled inflow rate to the open pit, or other model boundary nodes, without changing the modelled groundwater levels.

To account for the uncertainty in the observed rate of groundwater inflow to the open pit, the maximum and minimum of the four predicted inflows were factored up or down. The scale factor was assessed based on the adopted rate of groundwater inflow to the open pit of 950 m³/d on 1 January 2020 which was used for model calibration. At each time point in Figure 10-6, the minimum of the four predicted inflows was scaled by 0.79 (750 divided by 950) and the maximum by 1.16 (1,100 divided by 950) to obtain the minimum and maximum inflows shown in the figure. For the reasons described above and in Section 8.2.5, this is considered appropriate as running the model for these two cases is unlikely to provide any significant additional information.

Figure 10-5 shows the predicted inflow into the open pit, stopes and access tunnels using the adopted model parameters. Figure 10-6 shows the range of predicted inflow during 2022 to 2039 allowing for model parameter and observational uncertainty. Figure 10-7 shows the predicted inflow into each of the mine areas during 2022 to 2039 using the adopted model parameters.

The adopted groundwater inflow estimate for mine planning should be assessed based on consideration of the results shown in Figure 10-6, noting that each of the parameter sets are equally probable based on calibration of the numerical model to field observations as described in Section 8.2 and Section 8.3.

10.3.1 Effects of increased fracturing of rock above stopes

An assessment of the potential effects on inflows if stoping development were to result in increased fracturing in the rock overlying the stopes was carried out. The model was run with the horizontal and vertical hydraulic conductivity of the Primary Rock in the area of the stopes, from the level of the base of highest level of stoping up to the interface with the Saprock unit, increased by a factor of 10. The maximum predicted increase in inflow during the period 2020 to 2056 was less than 2 %. This can be understood by considering the low vertical hydraulic conductivities in the Transported, Saprolite and Saprock units overlying the stopes. These units have a combined thickness of between 50 m and 100 m in the area above the stopes. Additionally, as the stoping progresses to depths reaching up to 900 m below the ground surface (see Figure 7-6), a large proportion of the total inflow is predicted to be from flows into the deepest stopes from the nearby rock, rather than from sources close to the ground surface.

10.3.2 Effects of increased hydraulic conductivity of lake bed sediments

An assessment of the effects on inflows resulting from a higher hydraulic conductivity in the Transported Unit was carried out by factoring the horizontal and vertical hydraulic conductivity of the Transported Unit up by a factor of 10. The predicted increase in inflow to the stopes and tunnels during the period 2020 to 2056 was less than 2 %. This can be understood by considering that

between the base of the Transported Unit and the top of the highest stopes at approximately 80 m AHD, there is an approximate combined thickness of 60 m to 100 m of Saprolite, Saprock and Primary Rock. The vertical hydraulic conductivities of these units is low based on the calibration of the numerical model to observed groundwater levels and open pit inflows between 2005 and 2020. An assessment of the uncertainty of the hydraulic conductivity of these units, based on observation data, is provided in Section 8.3.

10.4 Groundwater inflows post mine closure

Post mining, groundwater inflow to the open pit is expected to rise from approximately 500 m³/day in 2040 to 900 m³/day in 2066. During this time the access tunnel voids and the paste backfill in the stopes gradually fill with groundwater. From 2066 to 2240 the inflow rate to the open pit is predicted to gradually fall to approximately 600 m³/day.

Based on the currently approved mine plan with no underground development, assessed groundwater inflow to the open pit is similar to the assessment with the underground development, decreasing gradually from approximately 1000 m³/day in 2040 to approximately 600 m³/day in 2240. The difference in predicted inflow to the open pit between 2040 and 2066 is a result of groundwater inflow to the access tunnel voids and paste backfill between 2040 and 2066 for the underground development assessment. This reduces the rate of groundwater inflow to the open pit during this time.

The difference in predicted inflow rates between the dry lake case and the flooded lake case is negligible. This is a result of the low vertical permeabilities of the hydrogeological units.

Following mine closure, during the period from 2040 to 2066, groundwater inflow into the access tunnel voids and paste backfill in the stopes is predicted to fall from 1,650 m³/day to less than 100 m³/day, as shown in Figure 10-5.

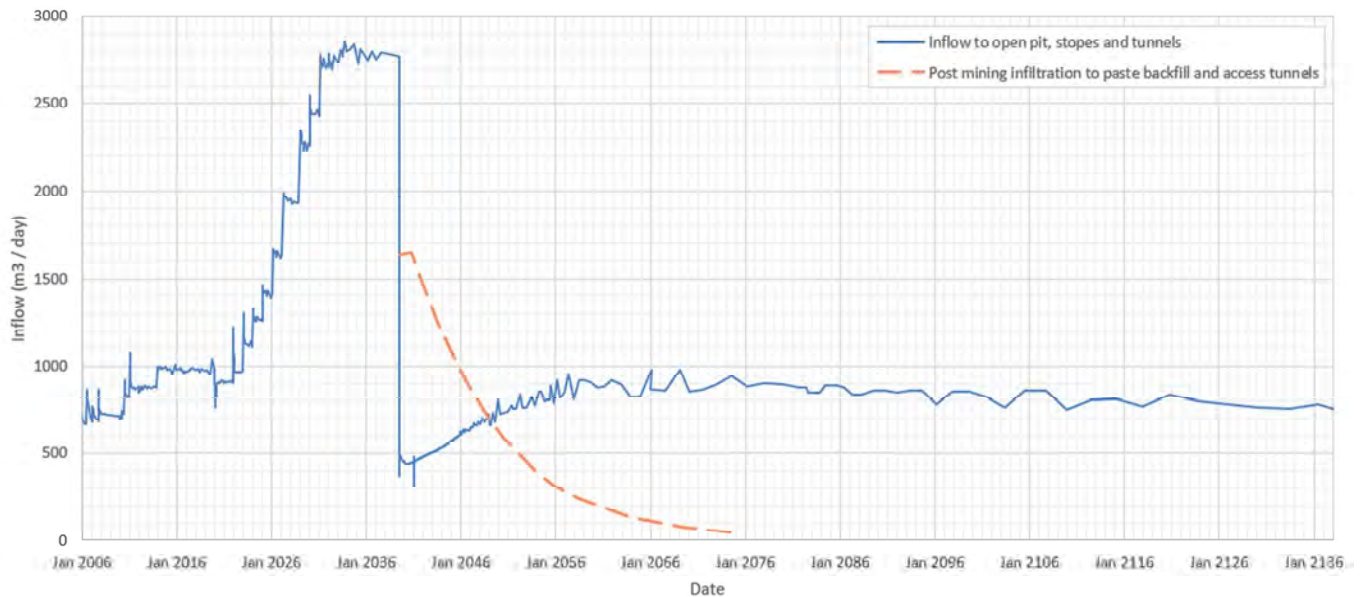

Figure 10-5: Predicted groundwater inflow to the open pit, stopes and access tunnels (2006 to 2138)

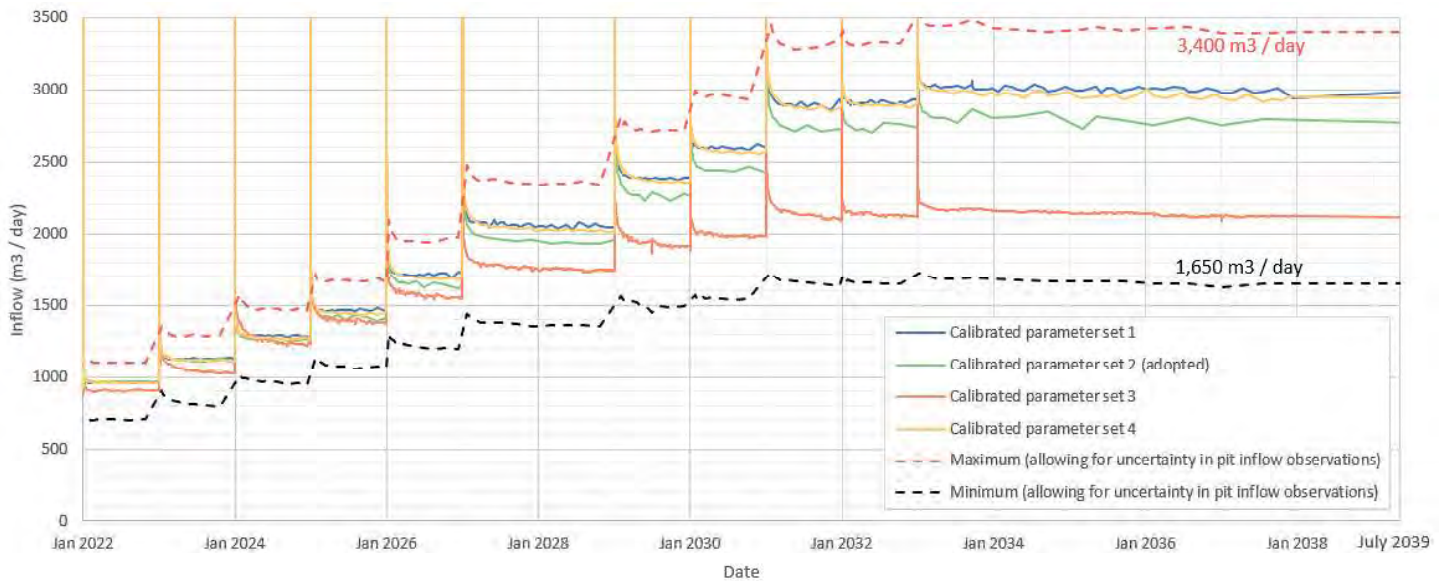

Figure 10-6: Predicted groundwater inflow allowing for model parameter and observational uncertainty (2022 to 2039)

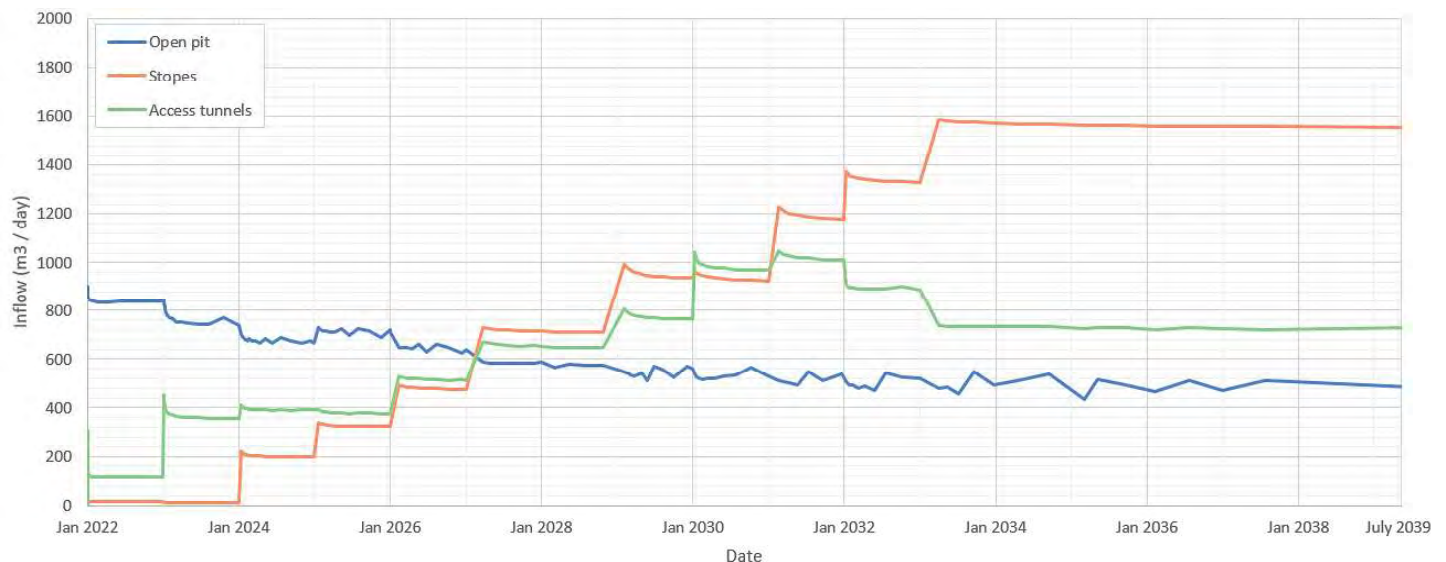

Figure 10-7: Predicted groundwater inflow into each of the mine areas (2022 to 2039)

10.5 Potential impact on Lake Cowal

Lake Cowal is a surface water fed water body, originating from Bland Creek and occasional flooding of the Lachlan River. It is separated from the proposed underground development by a 120 m combined thickness of lake sediments and extremely weathered to fresh rock, with vertical permeabilities of less than 1×10^{-3} m/day. As a result of the low vertical permeabilities, the majority of groundwater inflow (1,800 m³/day) will be from deep groundwater originating in the rock surrounding the underground development and not from Lake Cowal.

When Lake Cowal is full it occupies an area of 13,000 hectares, and would thus lose on average 200,000,000 m³/day to evaporation (assuming 1.5 m net pan evaporation, refer to Table 4-1). This means that the average rate of evaporation from the surface of Lake Cowal is approximately 100,000 times the predicted maximum rate of groundwater inflow to the whole underground development. As such, the impact of mine groundwater inflow on the water levels of Lake Cowal is considered to be negligible.

10.6 Groundwater quality related to open pit and stopes dewatering

The quality of groundwater collected by the dewatering system (including groundwater both pumped from vertical dewatering bores and seeping into the open pit and stopes) is expected to be similar to existing groundwater quality and would be used as a water supply for the processing plant. The expected concentration/value range for a number of analytes is provided in Figure 10-5. Pit dewatering will only have a small and localised (i.e. within ML1535) impact on groundwater quality.

Table 10-1: Expected dewatering groundwater quality

Analyte	Concentration (mg/L) or value
pH	5.8 to 7.1
Dissolved sodium	8,000 to 13,000
Sulphate	2,500 to 7,000
Alkalinity (bicarbonate)	80 to 500

10.7 Contaminant migration

Modification 16 involves a height increase from 245 m AHD to 246 m AHD to the final rehabilitated height of the IWL which is currently being developed as part of the approved Modification 14. This increase in height is approximately 3% of the height of the IWL, which has a base elevation of 213 m AHD, as shown in Table 7-1. A height increase of this percentage is assessed to have a negligible impact on the concentration of contaminants migrating from the IWL.

This section provides an assessment of the movement of contaminants originating from the IWL over a period of up to 200 years after mine closure. Contaminants identified as having the potential to be released from the IWL include cyanide, arsenic, zinc and other heavy metals (Coffey, 2018a). It should be noted that of these, cyanide is the only substance introduced by the mining operation the metals and arsenic derive from the mine ore.

10.7.1 Adopted porosity and retardation coefficient due to sorption

A key parameter for the modelling of particle tracking is the effective porosity of the soil/rock medium. Based on our experience with bedrock of similar nature, we consider an effective porosity of 0.01% in the rock to be reasonable for the modelling of the velocity at which water travels through the rock medium.

The movement or transport of contaminants is slower relative to water in an aquifer due to the sorption phenomenon, which is a physical or chemical process by which the solute partitions between groundwater and the soil or rock. This induces a retardation effect to the movement of contaminants in groundwater aquifer. Sorption processes include adsorption, absorption, chemisorption and ion exchange.

The retardation factor due to sorption is defined as:

$$R = 1 + \frac{\rho K_d}{n}$$

Where:

R = Retardation factor

ρ = dry density of soil/rock (ML^{-3})

K_d = Partitioning coefficient in matrix material of fractured media (L^3M^{-1})

n = Total porosity

Review of soil water partition coefficients for cyanide, arsenic, zinc and other heavy metals tested at Lake Cowal are presented in Table 10-2 (sourced from the Risk Assessment Information System by the US Department of Energy, Office of Environmental Management (rais.ornl.gov)). The results indicate that cyanide has the lowest K_d of the contaminants considered and therefore the other substances would migrate more slowly than cyanide.

Table 10-2: Soil-water partition coefficient

Contaminants	Soil-Water Partition Coefficient, K_d (cm^3/g)
Arsenic	29
Cadmium	75
Copper	35
Iron	25
Cyanide	9.9
Lead	900
Manganese	65
Mercury	52
Nickel	65
Zinc	62

Assuming the dry density of the rock to be 2.4 t/m^3 and the total porosity to be 10%, the retardation factor (based on K_d of 9.9) is predicted to be 240.

Based on our findings above, we have conservatively adopted a retardation factor of 20 in our particle tracking simulation (this is conservative for all other contaminants, such as heavy metals, which have much higher K_d coefficients). This retardation of the movement of contaminants was modelled by increasing the effective porosity by a factor of 20 (e.g. adopting effective porosity of 0.2% for the rock).

10.7.2 Decay in cyanide concentration

Cyanide is subject to gradual decay typically characterised by a half-life (the time for concentration to fall to half its initial value). The rate of decay is uncertain in the conditions beneath the IWL, with half-lives of the order of 300 days quoted for anerobic conditions and much shorter half-lives quoted for aerobic conditions which would apply at the surface of the water in the mine void. For a half-life of 300 days, an initial concentration of 20 mg/L (the concentration of cyanide in tailings delivered to the IWL) would reduce to below 0.001 mg/L after 12 years.

10.7.3 Modelling results

Release points were modelled beneath the footprint of the IWL at the base of the Sapolite unit at approximately 150 m AHD. These release points assume that there is presence of contamination within the Sapolite at time of mine closure and conservatively disregard remaining delays in migration through the lining beneath the tailings storage.

The results show groundwater head conditions in the area surrounding the CGO and the paths taken by the modelled tracer particles. Along each of the tracer lines are isochrone markers which show the timing of movement of the particles along their respective tracer lines over equally spaced time intervals.

10.7.3.1 Lake dry scenario

For the dry lake scenario, hydraulic head contours at the base of the Saprolite unit and the transport of contaminants are presented in Figures D1 to D4 in Appendix D.

Groundwater levels gradually change with a slow expansion of the cone of depression around the mine pit and gradual rise in water level within the mine void. As water levels rise in the pit the head gradients towards the pit gradually reduce.

From the simulation results, it can be seen that the contaminants travel beyond the IWL up to 900 m, 1,300 m, 1,700 m and 2,300 m in 20, 50, 100, and 200 years post mine closure respectively (not including particles that travel directly into the mine void). Figure 10-8 and Figure 10-9 show a plan and a section view of the predicted movement of contaminants from 2038 to 2058.

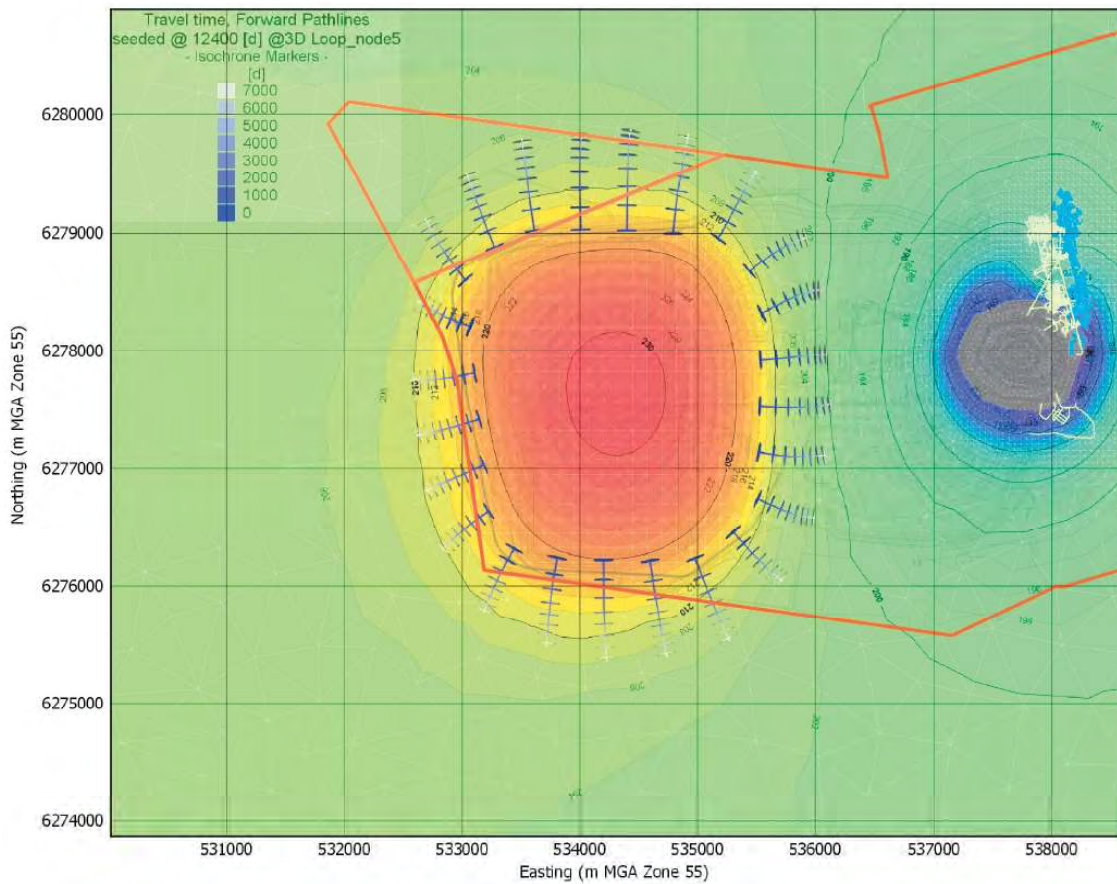

Figure 10-8: Plan view showing predicted movement of contaminants from 2038 to 2058

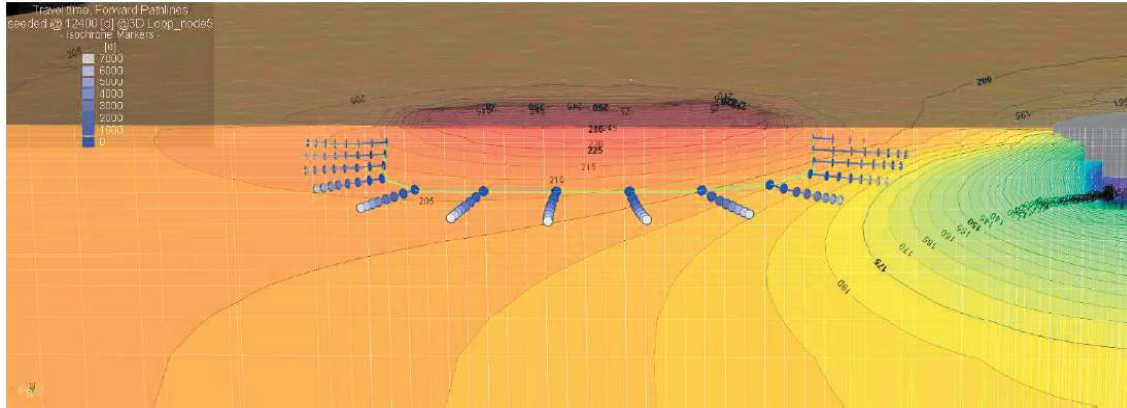

Figure 10-9: Section view looking north showing predicted movement of contaminants from 2038 to 2058

Contaminant particles tend to move initially downward due to the higher groundwater head directly beneath the IWL. They then move horizontally outwards and slightly upwards as the groundwater head equilibrates, similar to flow under a dam wall, for example. Some of the particles are modelled as reaching the ground surface, particularly to the north of the IWL. The movement of particles is entirely contained within the Transported, Saprolite and Saprock units, except for at the edge of the open pit where some particle paths pass through the Primary Rock unit. This is a result of the calibrated vertical hydraulic conductivities being an order of magnitude lower than the horizontal hydraulic conductivities.

Figures D1 to D4 in Appendix D show that the influence of the open pit void on groundwater flow patterns is felt mainly in the Primary Rock unit, except to the east of the IWL where some influence of the open pit void can be seen in the groundwater head contours in the Transported, Saprolite and Saprock units. As such, particles that leave towards the west from the IWL are not redirected toward the open pit within 200 years. The figures show that particles which leave towards the north from the IWL tend to daylight at the ground surface in or within 1 km from the mining lease.

The modelling results for 20 years post mine closure show movement to approximately 900 m away from the IWL. Monitoring to date after more than ten years of mine operation and storage of mine tailings has not resulted in sustained measurement of cyanide in the monitoring network, which includes monitoring points within 300 m of the tailings storage facility. These results are interpreted to indicate that the modelled movement of cyanide from the IWL is conservative, and that the modelled extent is over estimated. Of the substances considered (cyanide and heavy metals) cyanide is expected to be the more mobile because of the published information shows that the partitioning between cyanide and soil and rock is lower than for heavy metals. As a result, movement of other substances is expected to be slower than for cyanide.

The modelling does not take account of decay in cyanide concentration with time, which was discussed in Section 10.7.2. Taking account of decay leads to the conclusion that cyanide concentrations are anticipated to fall well below detection levels after 12 years and so measurable concentrations of cyanide are not anticipated to migrate beyond 1 km from the perimeter of the IWL.

10.7.3.2 Lake full scenario

The results for the lake full scenario were found to be approximately equal to the lake dry scenario. This is understandable considering the lake lies to the far side of the open pit from the IWL.

11 Groundwater licensing and aquifer interference policy considerations

11.1 Licensing

The NSW *Water Act 1912* governs water licensing, and the trading and allocation of licences, for both groundwater and surface water resources in NSW where a water sharing plan has not been implemented. The *Water Act 1912* applies to extraction of groundwater, extraction of water from a river, aquifer interference and capture of surface runoff to dams. The *Water Act 1912* is in the process of being progressively phased out and replaced by the NSW *Water Management Act 2000* (WMA).

Water Sharing Plans are statutory plans for specific water resource areas under the WMA that provide the rules for sharing and managing water resources in NSW. The *Water Act 1912* is repealed for a water resource area once a Water Sharing Plan has commenced for that area, and existing licences are converted to new consents under the WMA.

- The Water Sharing Plan for the Lachlan Unregulated and Alluvial Water Sources, 2012 commenced on 14 September 2012 and provides the framework for managing groundwater in the Lachlan aquifer until July 2023. The Bland Creek Palaeochannel Borefield and Eastern Saline Borefield operated by CGO draw groundwater from the Lachlan Formation for mine use. These borefields lie within the Upper Lachlan Alluvial Zone 7 Management Zone. ML1535 lies within the Upper Lachlan Alluvial Zone 7 Management Zone.
- The Water Sharing Plan for the NSW Murray-Darling Basin Fractured Rock Groundwater Sources, 2011 commenced on 16 January 2012 and provides the framework for managing groundwater in the fractured rock aquifers until July 2022. ML1535 lies within the Lachlan Fold Belt groundwater source of the Murray-Darling Basin. Groundwater seepage to the open pit results in extraction of groundwater from the Lachlan Fold Belt (alluvial areas are excluded in this source area). Table 11-1 lists the statistics for the Murray-Darling Basin groundwater source as provided in the Water Sharing Plan.

Groundwater removal from the fractured rock at the CGO is managed under a Water Sharing Plan: i.e. the *Water Sharing Plan for the Murray-Darling Basin Fractured Rock Groundwater Sources*, which commenced on 16 January 2012. The current version is dated 5 July 2013 with the following amendments (1 July 2016) relevant to the CGO:

- Vary the amount of recharge reserved as planned environmental water as a result of recharge studies undertaken or assessed as adequate by the Minister.
- Modify the long-term average annual extraction limits as a result of recharge studies undertaken or assessed as adequate by the Minister.
- Establish available water determination rules and individual access licence account management rules for major utility access licenses.
- Restrictions on the granting and amendment of water supply works to protect water-dependent Aboriginal cultural assets.
- Allow for the granting of aquifer interference approvals and the management of aquifer interference activities.

These changes to the Water Sharing Plan do not affect the pre-existing licensing arrangements at the CGO mine site.

Table 11-1: Requirements for Water Sharing (Murray-Darling Basin Fractured Rock – Lachlan Fold Belt Groundwater Source)

Use	Share Component (ML/year)
Stock and domestic	74,311
Town water supply	5,101
Long-term average annual rainfall recharge	224,627 (high environmental value areas) 3,502,609 (non-high environmental value areas)
Environmental water	224,627 (high environmental value areas) 2,626,957 (non-high environmental value areas)
Long-term annual average extraction limit	875,652

11.1.1 Mine Site Groundwater Extraction

The numerical modelling predicts dewatering rates due to inflow to the open pit, stopes and tunnels, as shown in Figure 10-5. The equivalent average annual groundwater take modelled from 2020 to the end of mine life is approximately 796 ML/year (2,180 m³/day).

Peak predicted flow from 2031 to 2039 is 1,022 ML/year (2,800 m³/day).

The groundwater is predominantly sourced from the rock hydrogeological units. It is assessed that 90% of groundwater inflow originates from the fractured rock aquifer with the remaining 10% from the overlying sediments.

Existing mine groundwater inflows are assessed as 365 ML/year (1,000 m³/day) (interpretation of site dewatering records, refer to Figure 8-18).

A letter from DPI Water to Barrick (then the owners of CGO) titled “Cowal Gold Mine – Request for reallocation of water access licence under the water management act 2000” and dated 7 January 2014, states that the CGO holds licences to access 366 units share components in Lachlan Unregulated and Alluvial water sources and Upper Lachlan Alluvial Zone 7 Management Zone and another 3,294 unit share components in the NSW Murray-Darling Basin Fractured Rock Groundwater Sources.

These include allowance for pumping of 256 ML/year (700 m³/day) from the saline borefield (Upper Lachlan Alluvial Zone 7) and allowing 10% (37 ML/year, (100 m³/day)) of the pit groundwater inflow rate from the Upper Lachlan Alluvial Zone 7 deposits with the remaining 90% (329 ML/year (900 m³/day)) from the fractured rock aquifer.

The saline borefield is submerged and inaccessible when Lake Cowal contains water. Consequently, it is only available during periods when the lake is empty.

The predicted annual groundwater volumes required to be licensed within each Water Sharing Plan for the Modification are summarised in Table 11-2.

Table 11-2: Groundwater licensing requirement summary

Water sharing plan	Management zone / groundwater source	Predicted groundwater inflow / extraction volume requiring licensing (ML/year)		Currently licensed unit shares (February 2018)
		Existing	During modification	
Water sharing plan for the Lachlan Unregulated and Alluvial Water Sources	Upper Lachlan Alluvial Zone 7 Management Zone	Maximum 282	Maximum 293 ^a	366
NSW Murray Darling Basin Fractured Rock Groundwater Sources	Lachlan Fold Belt Groundwater Source	Average 212 Maximum 277	Average 759 ^b Maximum 1004 ^c	3294

a Includes 256 ML/year extraction associated with the saline supply bores within ML1535 based on peak usage of 0.7 ML/d, plus 10% of modelled maximum inflow from the Upper Lachlan Alluvial Zone.

b Modelled average total inflow (796 ML/year) minus average open pit inflow from Upper Lachlan Alluvial Zone (37 ML/year)

d Modelled maximum total inflow (1022 ML/year in 2031-2039) minus open pit inflow from Upper Lachlan Alluvial Zone (18 ML/year in 2021-2039)

Post mining groundwater inflows will gradually reduce as water levels rise within the mine void over time, until they are balanced by evaporation from the pit lake, as discussed in Section 9.1.1. The long-term inflow rate is assessed to be 230 ML/year (630 m³/day) from the fractured rock groundwater source and less than 7.3 ML/year (20 m³/day) from the Upper Lachlan Alluvial Zone, refer to Figure 10-5.

11.2 Aquifer Interference Policy Requirements

11.2.1 Mine Site

NOW's *Aquifer Interference Policy* (2012) provides a framework for assessing the impacts of aquifer interference activities on water resources.

Aquifer Interference Policy (NOW, 2012) is relevant to CGO as it applies to mining activities such as open cut voids and the disposal of water taken from aquifers.

Groundwater quality within ML1535 has EC generally in the range of 30,000 microsiemens per centimetre ($\mu\text{S}/\text{cm}$) to 55,000 $\mu\text{S}/\text{cm}$ for the Transported, Saprolite and Saprock units. Data are not available for the Primary Rock, but the EC in the Primary Rock is expected to be similar (or higher due to the presence of salts in the rock). This equates to a total dissolved solids concentration of between 19,200 mg/L and 35,200 mg/L. The groundwater source at CGO is, therefore, defined by the *Aquifer Interference Policy* (NOW, 2012) as a:

... less productive groundwater source ...

The minimal impact considerations specified in the *Aquifer Interference Policy* (NOW, 2012) for a less productive groundwater source include:

- (i) No more than a specified cumulative variation in the water table within 40 m from a high priority groundwater dependent ecosystem or a high priority culturally significant site.
- (ii) No more than a specified limit in the water table decline at any water supply work.

- (iii) No more than a specified cumulative pressure head decline at any supply work.
- (iv) Any change in groundwater quality that lowers the beneficial use category of the groundwater source beyond 40 m from the activity.
- (v) No increase of more than 1% per activity in long-term average salinity in a highly connected surface water source at the nearest point of activity.
- (vi) No mining activity below the natural ground surface within 200 m laterally from the top of the high bank and 100 m vertically beneath of a highly connected surface water source that is defined as a “reliable water supply”.

The model-predicted groundwater drawdown up to 20 years post-mine closure remains largely within ML1535. As there are no Groundwater Dependent Ecosystems (GDEs), priority culturally significant sites or supply works within ML1535 (or within 40 m of the boundary of ML1535), minimal impact considerations (i) to (iii) have been met.

Schedule 4 of the Upper Lachlan Alluvial Groundwater Source Water Sharing Plans nominates two high priority GDEs (Bogolong Springs and Old Man Springs). These GDEs are located more than 60 km to the east of the CGO, on the other side of the Bland Creek Palaeochannel. These GDEs are distant from the CGO and would not be affected by mining operations.

Schedule 3 of the NSW Murray-Darling Basin Fractured Rock Groundwater Sources Water Sharing Plan indicated that the closest high priority GDE to the CGO site is Cartwrights Spring, located more than 5 km east-south-east of the site. Coffey do not expect this GDE will be affected by the CGO.

A check was carried out on 15 January 2020 on the BoM's Atlas of Groundwater Dependent Ecosystems. The key findings are as follows:

- High potential aquatic GDE at Lake Cowal immediately east of the CGO, (as shown on Figure 11-1). This will not be affected as groundwater modelling and observations to date indicate that seepage from Lake Cowal arising from mining operations during periods of inundation is negligible.
- High potential terrestrial GDE approximately 4.5 km north of the CGO comprising Grey Box-White Cypress-pine woodland (as shown on Figure 11-2). From review of Figure 11-2, Coffey considers that this vegetation is unlikely to be groundwater dependant, based on knowledge of local groundwater conditions. This area is unlikely to be affected by the mining operation.
- Moderate potential terrestrial GDE surrounding the CGO comprises wetland sedgeland, Mixed Box Eucalypt woodland, and River Red Gum within or at the fringe of Lake Cowal during periods of inundation and is also subject to periods where lake waters are absent between flood events (as shown on Figure 11-2). The movement water in the lake shore will not be affected by mining operations as the seepage from the lake to the open pit, stopes and access tunnels is assessed as being negligible. Further, these communities are considered more likely to be influenced by soil moisture increases during lake full conditions than by the regional or local groundwater resource. As a result, they are considered unlikely to be affected by the mining operations.
- Low potential terrestrial GDE surrounding the CGO comprising Tussock grasslands (as shown on Figure 11-2). These areas may be affected by changes in soil moisture depending on the root depths. However, the CGO's impacts on the underlying hard rock aquifers are considered to be unlikely to affect any Tussock grasslands.

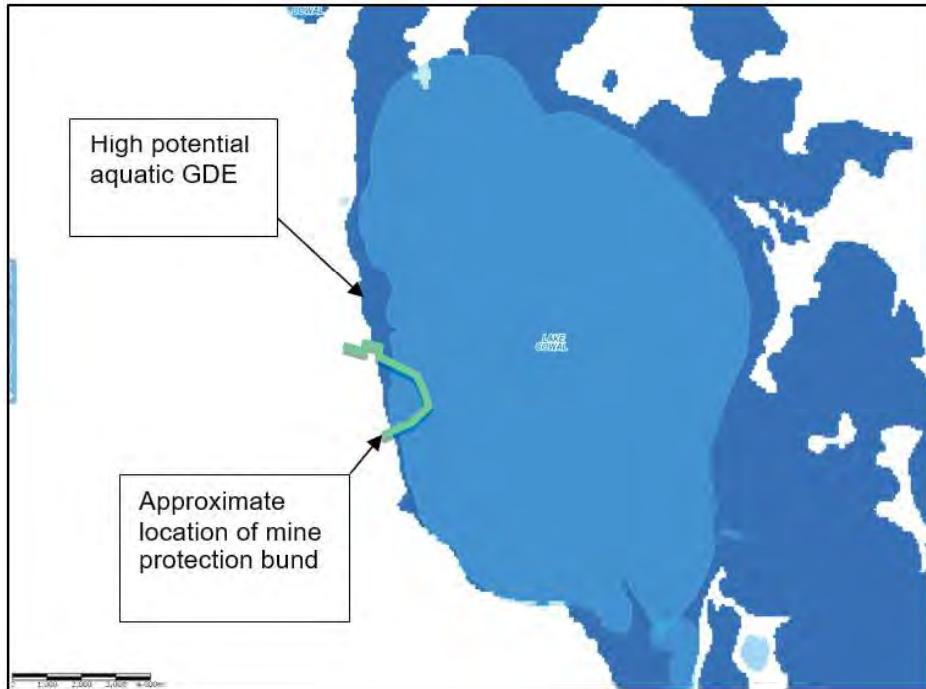

Figure 11-1: BoM Atlas of Groundwater Dependent Ecosystems (Aquatic)

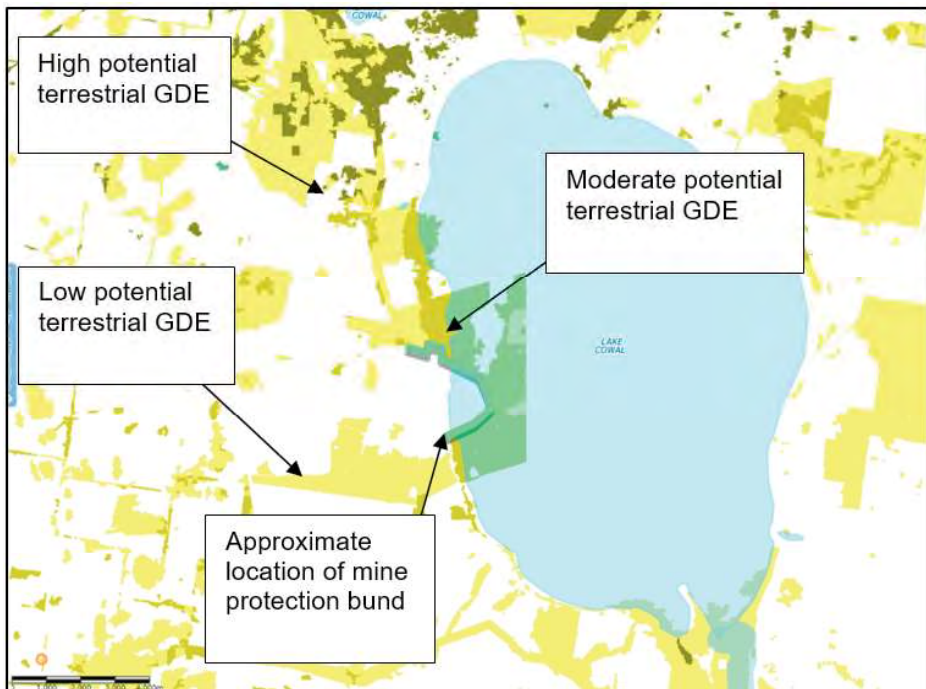

Figure 11-2: BoM Atlas of Groundwater Dependent Ecosystems (Terrestrial)

During the life of the CGO, dewatering from the open pit, stopes and access tunnels will only have a small and localised (i.e. within ML1535) impact on groundwater quality. Over the longer term, groundwater will flow towards the open pit, ultimately terminating there. The groundwater quality in the region surrounding the open pit void is not expected to change significantly due to this process, though the quality of the water within the open pit is expected to change (e.g. salinity will increase). The beneficial use of groundwater is not expected to change due to dewatering or the presence of the open pit. Thus, minimal impact consideration (iv) is met.

As the equilibrium surface water level in the open pit (the pit lake) following the end of mining will be well below the ground surface (refer to Section 9.1.1), water from the pit lake will not be released. Thus, it is not classified as a highly connected surface water source, meeting minimal impact consideration (v).

Coffey is not aware of any “reliable water supplies” within 200 m laterally from the top of the high bank. Lake Cowal is an ephemeral lake, and so is not considered by Coffey to be a “reliable water supply”. Thus, minimal impact consideration (vi) is met.

12 Management and mitigation measures

12.1 Groundwater Levels around the Tailings Storage Facilities

Groundwater levels in piezometers in the vicinity of the TSFs have shown increases in levels in recent years. Of these, the largest rises were recorded at MON02A and MON02B (screened in the Saprock and Saprolite units, respectively) which have displayed a gradual rise since late 2006. Groundwater level variation around the TSFs was investigated by Coffey (2009a) and further investigations were carried out in 2016 by Northern Resource Consultants, where the rises were assessed to be related to the percolation and the movement of seepage from the TSFs.

Ground surface elevation at the MON02 piezometer nest is at about 222 m AHD. In late 2015 groundwater level was approximately 11 m below the ground surface (Northern Resource Consultants, 2016). The screen midpoints are at about 66 m and 27 m below ground at MON02A and MON02B respectively. The equality of water levels at these piezometers suggest minimal vertical hydraulic head gradients, with the potential for shallow hydraulic heads to be the same as deeper in the profile, at that location.

If the current trends were extrapolated linearly the water level at MON02A / MON02B would reach the ground surface at 222.4 m AHD at the end of 2026. This provides sufficient time to develop and design mitigation measures should they prove necessary. Following mine closure, the elevated groundwater levels are expected to dissipate over time as the water levels within the TSFs gradually reduce.

As the water level rises at MON02A and MON02B are interpreted to be associated with seepage from the TSFs Coffey recommends:

- Continuation of monitoring of piezometers in the vicinity of the TSFs;
- Installation of new monitoring piezometers to replace those which will be destroyed (including MON02A and MON02B) by the construction of the IWL, allowing at least six months of overlap so that correlations between the new monitoring piezometers and the ones they will replace can be developed;
- Review of groundwater levels on an annual basis; and
- Should existing trends continue, develop a groundwater control plan and design control measures to address water level rise which could include:
 - Augmentation of the existing monitoring network;
 - Pumping groundwater from bores introduced in the vicinity of MON02 back to the TSFs; and/or
 - Installation of trench drains and sumps to collect groundwater and suppress further rise in groundwater levels.

13 Conclusions

13.1 Groundwater impacts due to open pit and underground mining

The following points summarise the main findings relating to groundwater impacts due open pit and underground mining:

- Groundwater table drawdown due to open pit and underground mining is predicted to generally remain within ML1535 / ML1791 during the mine life and post mining.
- Groundwater head drawdown due to open pit and underground mining is predicted to generally remain within ML1535 / ML1791 during the mine life, except in the primary rock unit.
- Groundwater inflows to the open pit and underground mine are predicted to range between approximately 1,000 m³/day and 2,800 m³/day between 2020 and mine closure. This would result in maximum groundwater inflows of 1002 ML/year within the fractured rock groundwater system and 37 ML/year within the alluvial groundwater system.
- There is a negligible difference between dry and inundated lake scenarios. This is a result of the low vertical hydraulic conductivities of the hydrogeological units. These were calibrated based on 22 monitoring wells with groundwater level observations between 2005 and 2020 and on observed inflows to the open pit.
- Pit dewatering water quality is expected to be similar to historical conditions.
- Groundwater quality within ML1535 is expected to be similar to historical conditions.

The impact of the underground development only (excluding the effects related to the currently approved mine) is summarised below:

- The effect on predicted groundwater table drawdown at the end of underground mining caused by the underground development is assessed to be very small to negligible.
- The effect on predicted groundwater heads caused by underground development is assessed to be confined primarily to the Primary Rock unit, with very small to negligible effects in the overlying Transported, Saprolite and Saprock units.
- The additional groundwater inflow caused by the proposed underground development is assessed to increase from zero in 2022 to a peak of approximately 1,800 m³/day in 2031 and then continue at approximately this rate until the end of mining in mid-2039.
- Between mid-2039 and approximately 2066 the access tunnel voids and the fillable porosity in the stopes paste backfill gradually fill with groundwater. After this time the impact of the underground mine is assessed to be negligible.

13.2 Impacts on Lake Cowal due to open pit and underground mining

Modelling results indicate negligible impact on Lake Cowal due to open pit and underground mining.

13.3 Groundwater quality impacts due to potential seepage from the TSFs and IWL

Conservative assessment of potential impacts to groundwater quality due to seepage from the IWL suggest that after 100 years the potential for groundwater quality changes due to seepage from the IWL stored water will extend a distance of up to approximately 2 km from the IWL walls. Consideration of Cyanide decay times indicates that Cyanide concentrations are predicted to fall well below detectable limits beyond 1 km from the boundary of the IWL.

14 Recommendations

14.1 Data and Monitoring

Coffey recommends:

- Continued groundwater monitoring to validate the predictive modelling, particularly in the vicinity of the open pit, TSFs, stopes and access tunnels and ML1535 saline groundwater supply borefield.
- Establishment of new monitoring bores to replace those that would be displaced by the IWL, including MON02A, MON02B, P414A, P414B, P412A, P412A-R, TSFNA, TSFNB, TSFNC, MON01A, MON01B, P558A-R and P555A-R.

15 Limitations

15.1 Numerical simulation

The results reported are specific to the modelled conditions. In the absence of data, the models adopt conditions and parameter values assumed relevant. Should conditions differ from those adopted in the assessments made, results may vary significantly.

The results reported are subject to the uncertainty inherent in numerical modelling. The numerical models are necessarily simplifications of the real system and rely on calibration to data of unknown precision to produce predictive results. The results are estimates only and may differ from future observations.

16 References

- Allison, J.D., and Allison, T.L. (2005). Partition Coefficients for Metals in Surface Water, Soil and Waste. EPA/600/R-05/074, July 2005. U.S. Environmental Protection Agency Office of Research and Development Washington, DC 20460.
- Australian and New Zealand Environmental Conservation Council (1995). National Water Quality Management Strategy Guidelines for Groundwater Protection in Australia.
- Australian and New Zealand Environmental Conservation Council and Agricultural Resources Management Council of Australia and New Zealand (2000). Australian and New Zealand Guidelines for Fresh and Marina Water Quality.
- Australian Natural Resources Atlas (2009). Land Use - Lachlan River Basin 1995/1997. Department of Sustainability, Environment, Water, Population and Communities, Data updated 25 May 2009.
- Barnett, B., Townley, L.R., Post, V., Evans, R.E., Hunt, R.J., Peeters, L., Richardson, S., Werner, A.D., Knapton, A. and Boronkay, A. (2012), Australian Groundwater Modelling Guidelines, National Water Commission, Canberra.
- Barrick Australia Limited (2010). Saline Groundwater Assessment – Cowra Aquifer, Cowal Gold Mine, West Wyalong, NSW, Final Report, Project No. BARR010, October 2010.
- Bilge H. (2012). Upper Lachlan Groundwater Flow Model, NSW Office of Water, Sydney.
- Burden, R.J. and Kidd, C.H. (1987). The Environmental Fate of Cyanide in Gold Mine Process Tailings, Proceedings of Annual Conference. Australasian Institute of Mining and Metallurgy, Nelson, New Zealand.
- Bureau of Meteorology (2017a). Climate data online (<http://www.bom.gov.au/climate/data/>).
- Bureau of Meteorology (2017b) Groundwater Dependent Ecosystem Atlas (<http://www.bom.gov.au/water/groundwater/gde/map.shtml>).
- CMW Geosciences (2017). Integrated Waste Landform, Tailing Storage Facility – Cowal Gold Operations, NSW. Report No. PER2016-0917AI Design Report Rev1, 13 October 2017.
- Coffey Services Australia Pty Ltd (1995a). Lake Cowal Project Hydrogeological Modelling and Dewatering Study. Report No. G255/28-AF, 3 April 1995.
- Coffey Services Australia Pty Ltd (1995b). Lake Cowal Project Hydrogeological Study of Tailings Dams Area. Report No. G255/21-AD, February 1995.
- Coffey Services Australia Pty Ltd (1995c). Outside Borefield Feasibility Study for Lake Cowal Project, Report No. G255/24-AJ, February 1995.
- Coffey Services Australia Pty Ltd (1995d). Lake Cowal Project – Hydrogeological Modelling and Dewatering Study. Report No. G255/28-AF, April 1995.
- Coffey Services Australia Pty Ltd (1997). Groundwater Studies – Hydrogeological Assessment.
- Coffey Services Australia Pty Ltd (2006). Cowal Gold Mine, Groundwater Supply Modelling Study, Model Calibration. Report No. S21910/2AK, 15 September 2006.
- Coffey Services Australia Pty Ltd (2008). Cowal Gold Mine, Pit Dewatering Assessment. Report No. GEOTLCOV21910AC-AC, 5 August 2008.
- Coffey Services Australia Pty Ltd (2009a). Cowal Gold Mine, Groundwater Level Investigation. Report No. GEOTLCOV21910AF-AB, 26 March 2009.
- Coffey Services Australia Pty Ltd (2009b). Cowal Gold Mine, Groundwater Monitoring Review 2008. Report No. GEOTLCOV21910AE-AB, 24 February 2009.

- Coffey Services Australia Pty Ltd (2011). Cowal Gold Mine Augmentation Project, Hydrogeological Assessment. Report No. GEOTLCOV21910AJ-AL, 16 March 2011.
- Coffey Services Australia Pty Ltd (2012). Cowal Gold Mine, Groundwater Monitoring Review 2011. Report No. GEOTLCOV21910AV-AC, 5 September 2012.
- Coffey Services Australia Pty Ltd (2016). Cowal Gold Operations Mine Life Modification, Mine Site Hydrogeological Assessment. Report No. GEOTLCOV21910BG-AG, 10 November 2016.
- Coffey Services Australia Pty Ltd (2018a). Cowal Gold Operations Processing Rate Modification (MOD14), Mine Site Hydrogeological Assessment, Report No. 754-SYDGE206418-AA, dated 2 March 2018.
- Coffey Services Australia Pty Ltd (2018b). Cowal Gold Operations Processing Rate Modification (MOD14), Bland Creek Palaeochannel Borefield and Eastern Saline Borefield Groundwater Assessment, Report No. 754-SYDGE206418-BCPB, dated 24 March 2018.
- Coffey Services Australia Pty Ltd (2020a). CGO Underground Development EIS, Groundwater site investigations report, Report No. SYDGE206418-3-AJ, dated 6 April 2020.
- Coffey Services Australia Pty Ltd (2020b). Groundwater Monitoring Review 2019, Cowal Gold Operation, Report No. 754-SYDGE270760-AA, dated 30 April 2020.
- Coffey Services Australia Pty Ltd (2020b). Cowal Gold Operations Underground EIS, Bland Creek Palaeochannel Borefield and Eastern Saline Borefield Groundwater Assessment, Report No. 754-SYDGE206418-3-AG, dated T.B.A.
- Department of Land and Water Conservation (1997). The NSW State Groundwater Policy Framework Document.
- Department of Land and Water Conservation (1998). The NSW State Groundwater Quality Protection Policy.
- Department of Land and Water Conservation (2002). The NSW Groundwater Dependent Ecosystem Policy.
- Groundwater Consulting Services Pty Ltd (2006). Jemalong Water Supply Borefield Installation and Testing, Cowal Gold Project, West Wyalong, New South Wales. Report BARR003. August.
- Groundwater Consulting Services Pty Ltd (2008). Saline Groundwater Assessment – Alluvial Aquifer E42 Modification, Cowal Gold Mine, West Wyalong, New South Wales. Report BARR010, July 2008.
- Haines Surveys (2019), Lake Cowal 3 Gravity Survey, Evolution Mining Ltd, April - May 2019, Job No. 1906.
- Hawkes, G.E. (1998). Hydrogeology of the Proposed Lake Cowal Gold Mine, NSW. Unpublished MSc Thesis, University of Technology, Sydney.
- Hydro Engineering & Consulting Pty Ltd (2018). Cowal Gold Operations Processing Rate Modification – Hydrological Assessment. Prepared for Evolution Mining Pty Limited.
- Johnson, A.I. (1967). Specific Yield – Compilation of specific yield for various materials. USGS Water-Supply Paper 1662-D, 74p.
- Knight Piesold Pty Ltd (1994). Lake Cowal Project Laboratory Testing of Tailings, Reference 216/2, June 1994.
- Miles, I.N. and Brooker, M.R. (1998). Endeavour 42 deposit, Lake Cowal, New South Wales: a structurally controlled gold deposit, Australian Journal of Earth Sciences 45. 837-847.
- North Limited (1998). Cowal Gold Project Environmental Impact Statement. North Gold WA Limited, 13 March 1998.

- Northern Resource Consultants (2016). Groundwater Investigation - Progressive Groundwater Level Rise in MON02A and MON02B. March 2016.
- New South Wales Department of Environment and Conservation (2007) Guidelines for the Assessment and Management of Groundwater Contamination.
- New South Wales Office of Water (2012). NSW Aquifer Interference Policy.
- Outotec Pty Ltd (2020). Evolution Mining - Cowal Gold Mine, GRE46 Underground Project, backfill pre-feasibility study, Report No. P6058-R02 Rev0, dated 19 April 2020.
- Schmidt, J.W., L. Simovic and E. Shannon (1981). Development Studies for Suitable Technologies for the Removal of Cyanide and Heavy Metals from Gold Milling Effluents. Proceedings of the 36th Industrial Waste Conference, Purdue University, pp. 831-846.
- SNC-Lavalin Australia (2003). Cowal Gold Project Geotechnical Investigation Report. Report 334371-0000-4GRA-0001 prepared for Barrick Gold of Australia. URS Australia Pty Limited (2005). Cowal Northern Tailings Storage Facility – Floor Permeability, Reference 51755-005.
- URS Australia Pty Limited (2006). Cowal Southern Tailings Storage Facility – Floor Permeability, Reference 43167213.
- Watermark Numerical Computing (2004), PEST – Model independent parameter estimation, User Manual, 5th Edition, Watermark Numerical Computing.
- Williams, B.G. (1993). The Shallow Groundwater Hydrology of the Jemalong – Wyldes Plains Irrigation Districts, NSW Department of Agriculture, March.
- Zoback, M.D. (2007), Reservoir Geomechanics, Cambridge University Press

This page has been left intentionally blank

Appendix A - Groundwater monitoring

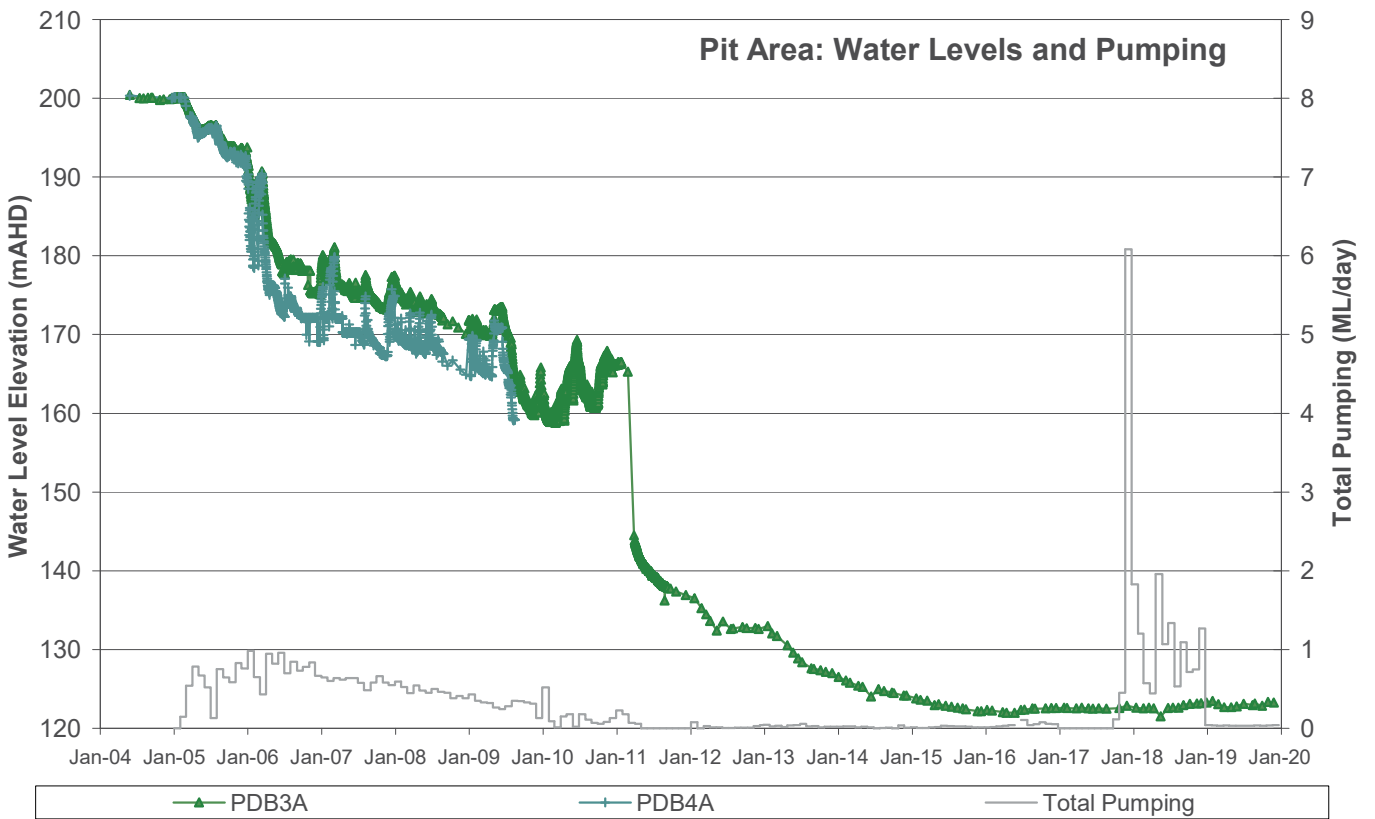
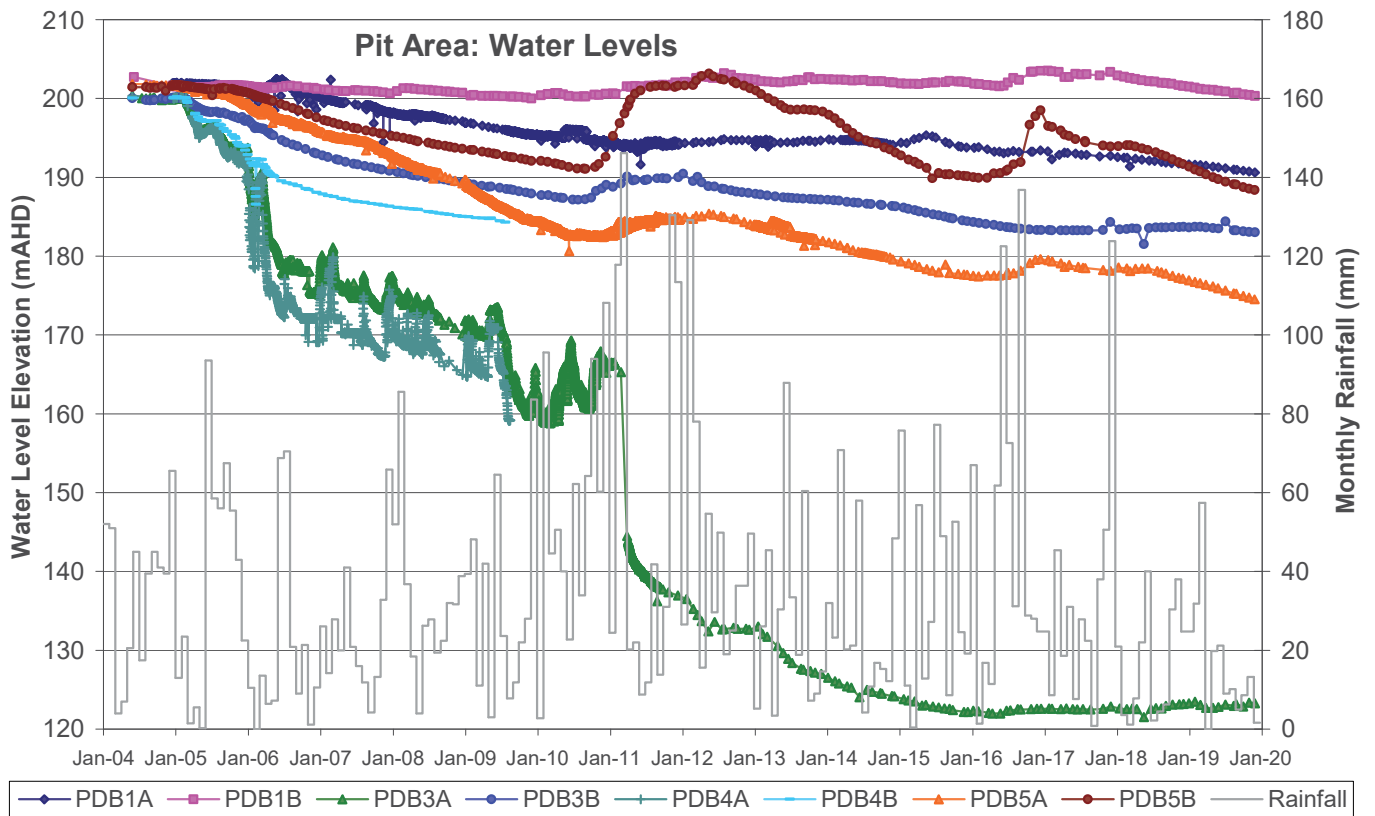

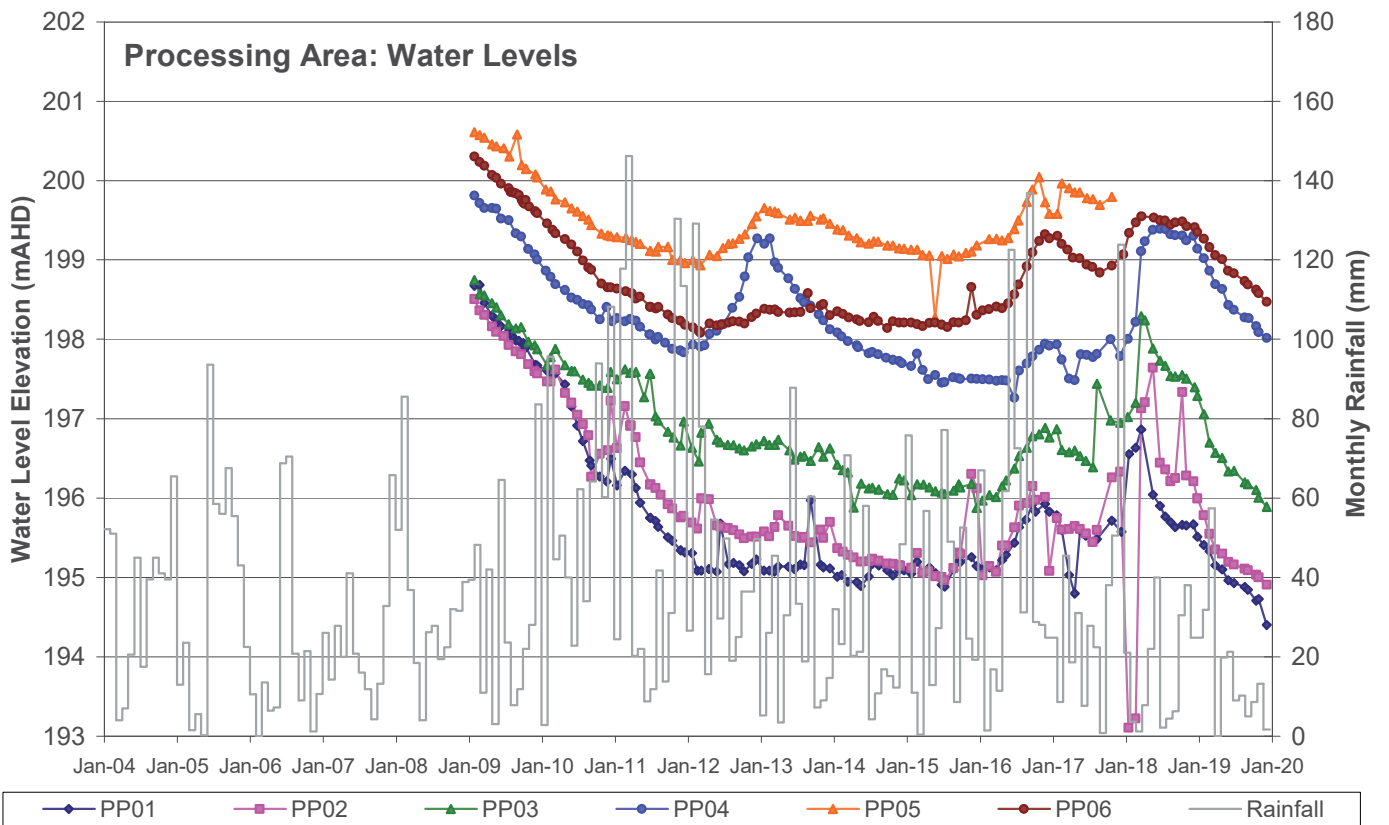

Groundwater hydrographs - CGO Underground Development EIS

Groundwater levels - UG-BH-01

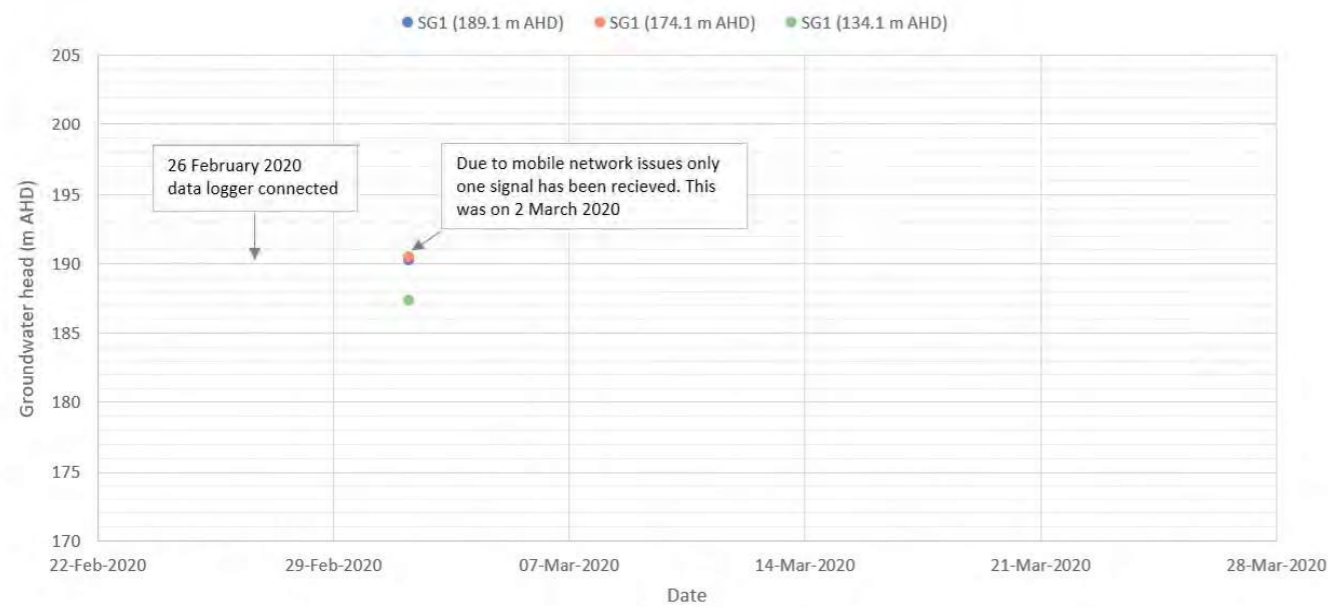

Groundwater levels - UG-BH-02

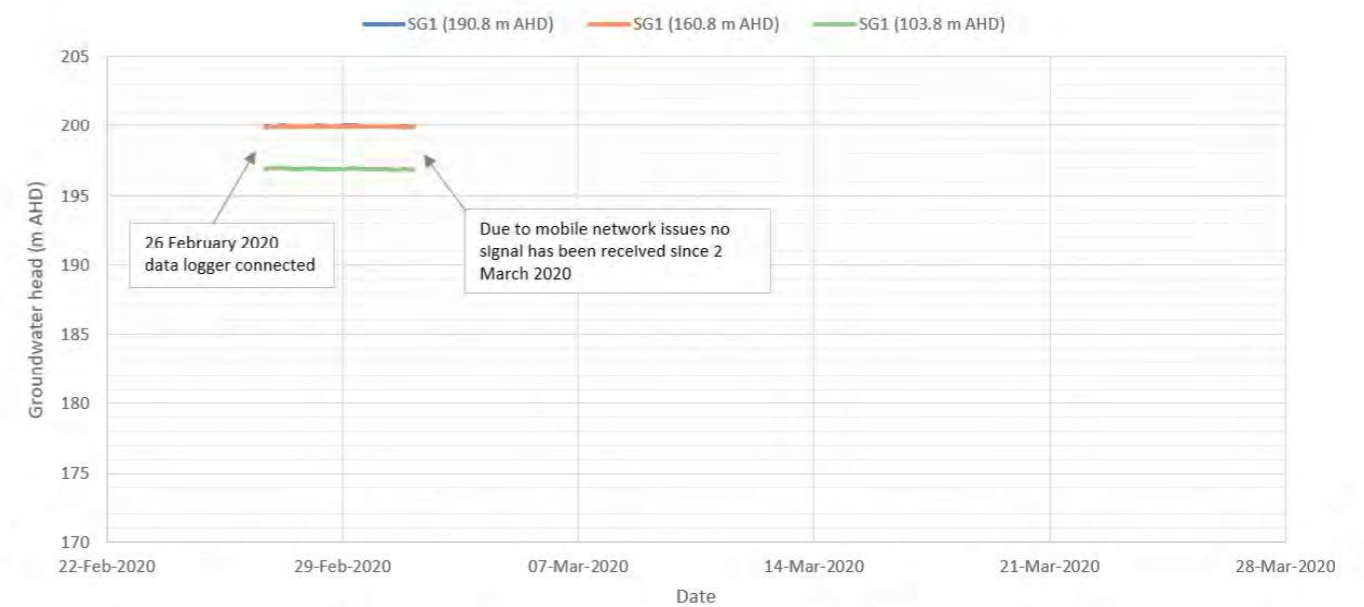

Groundwater levels - UG-BH-03

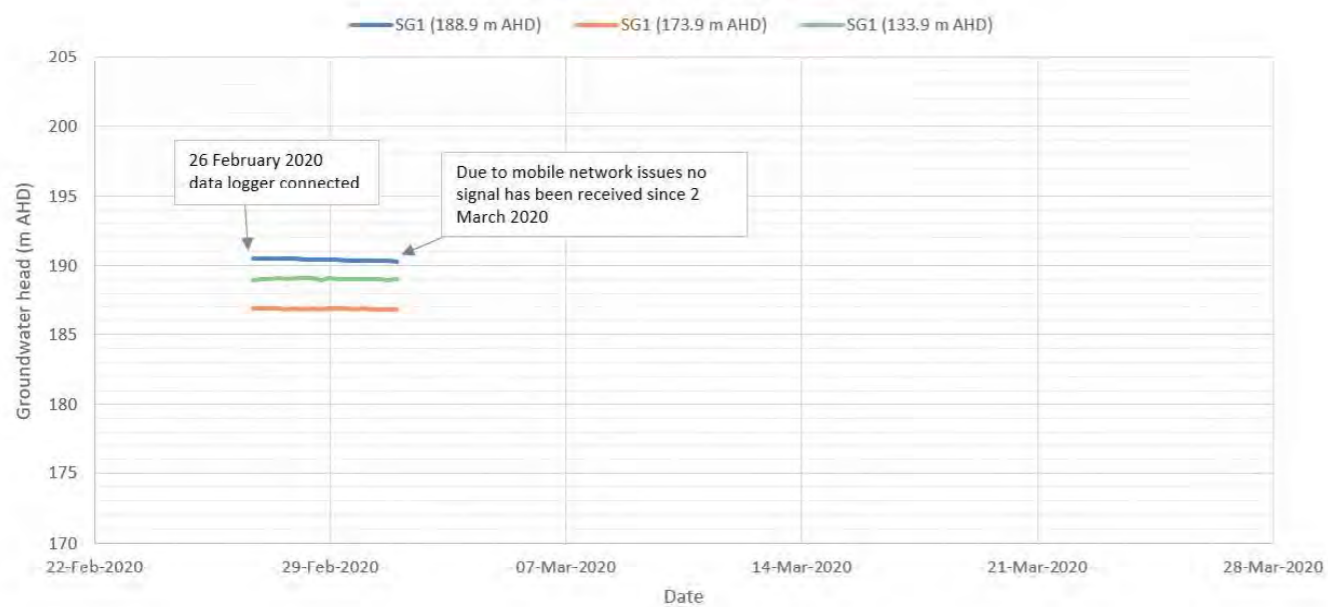

Groundwater levels - UG-BH-04

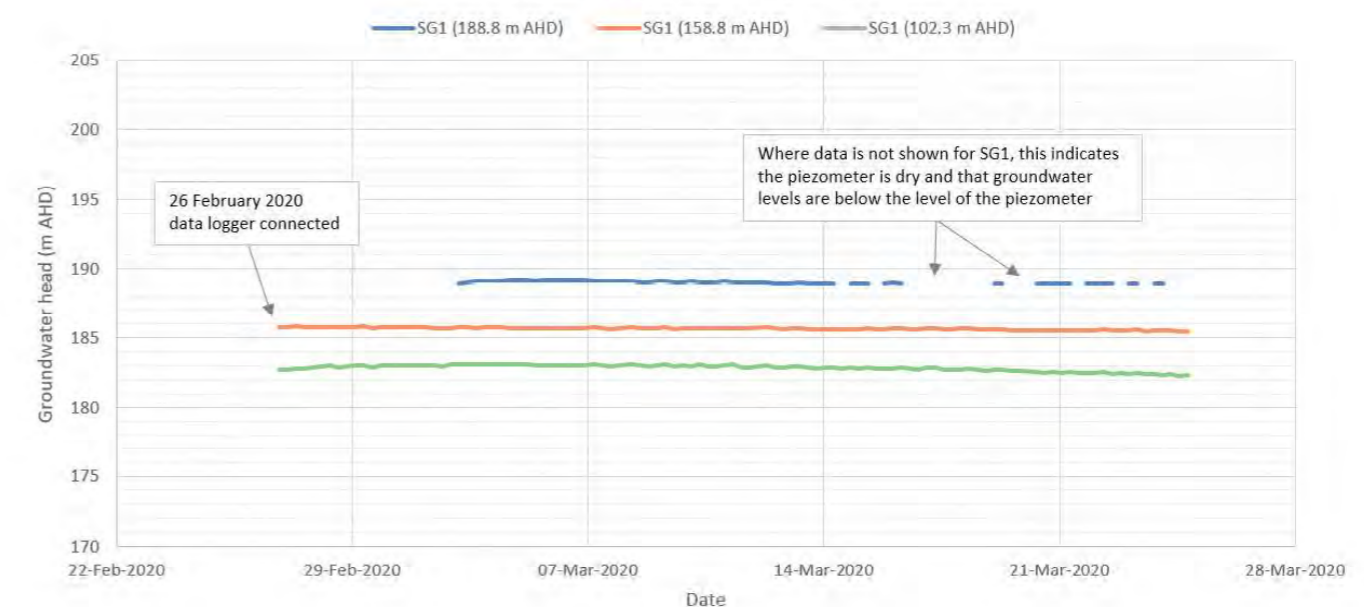

Groundwater levels - PZ13



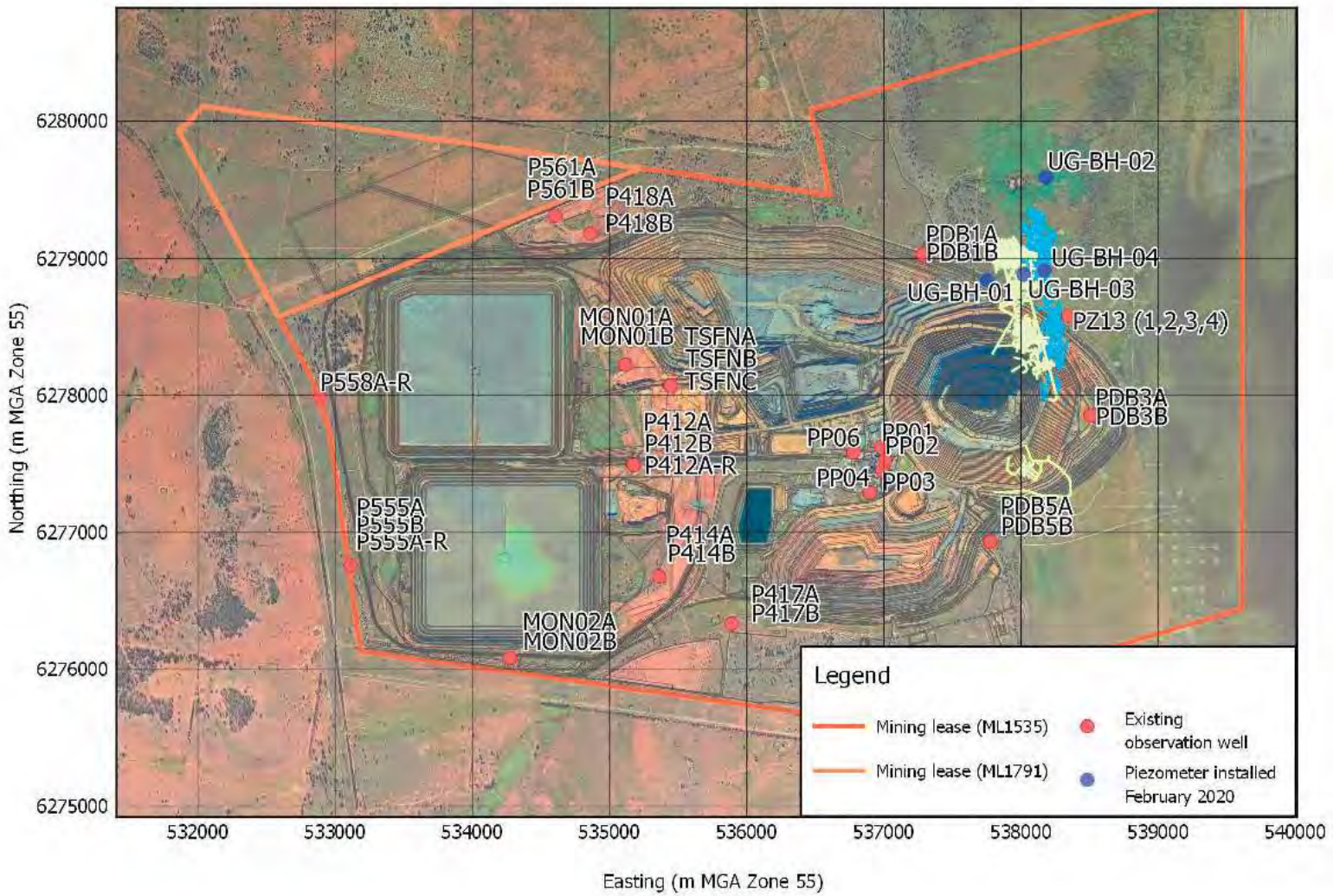

Appendix B - Groundwater calibration comparisons

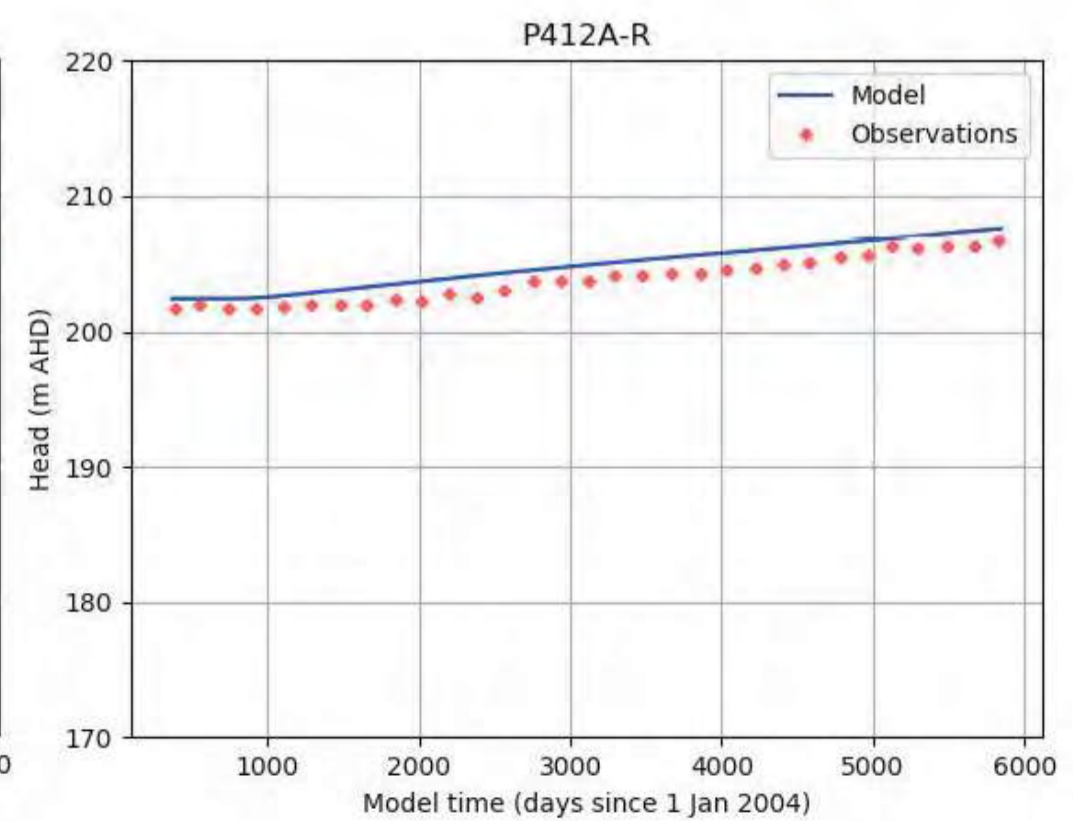
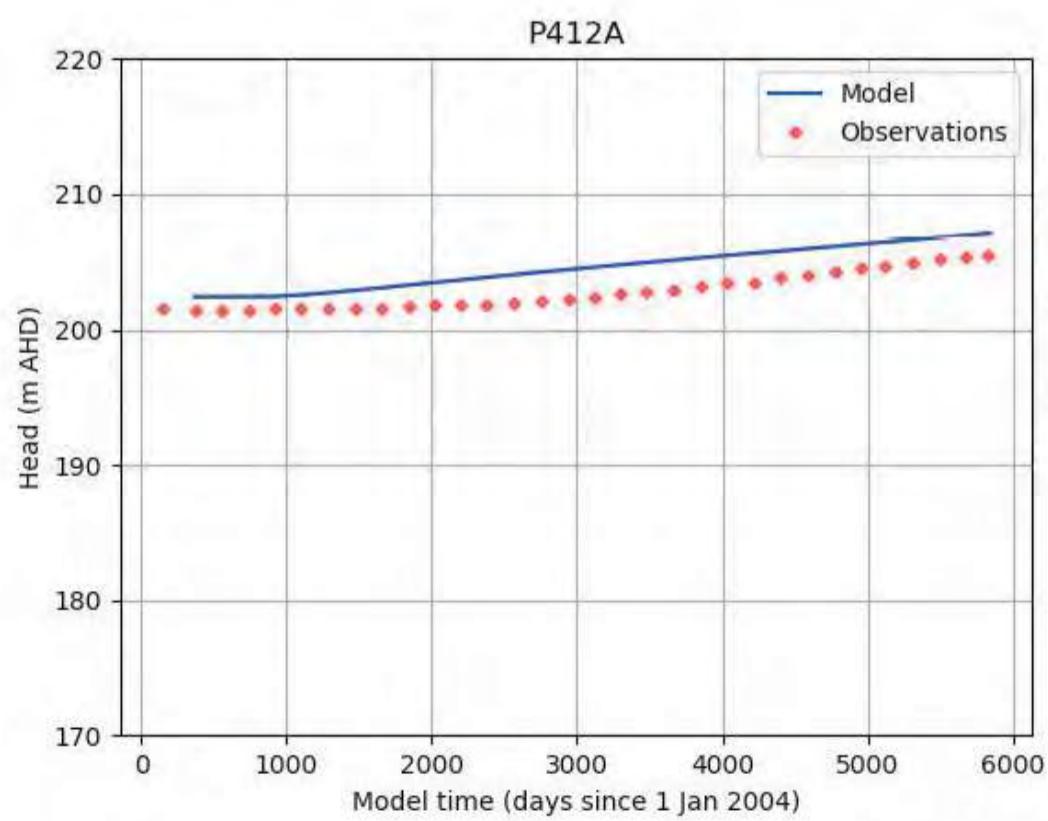
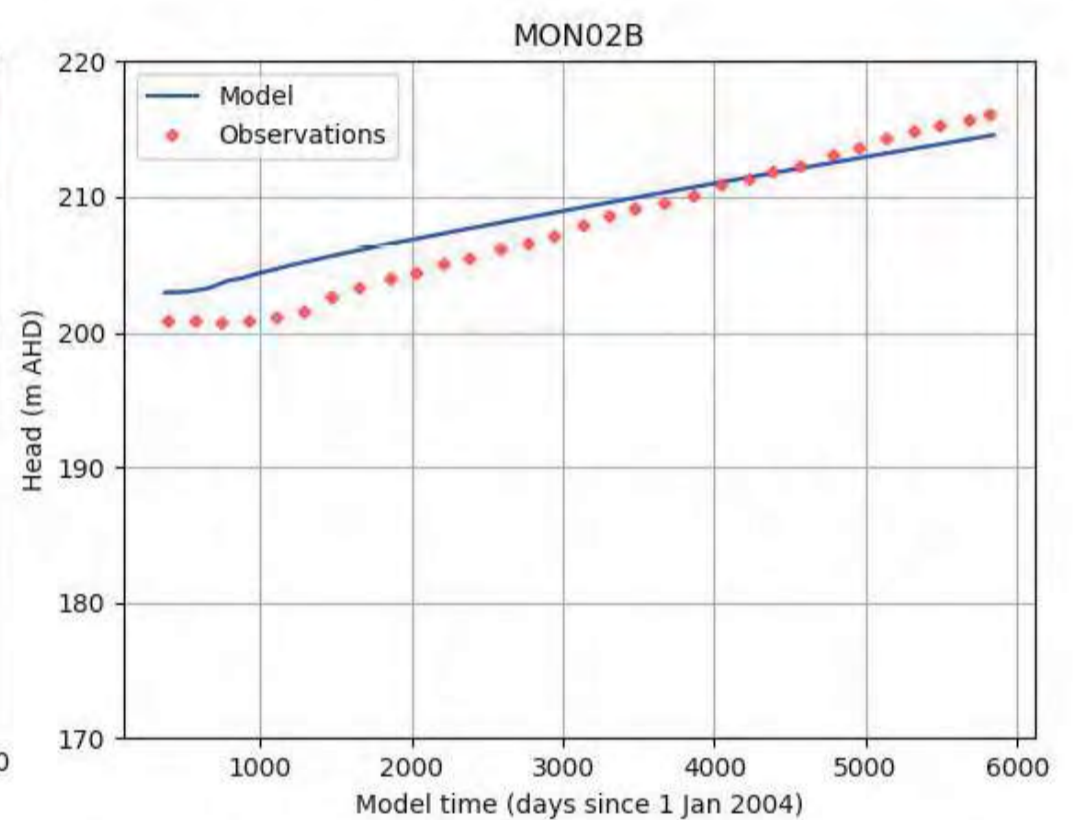
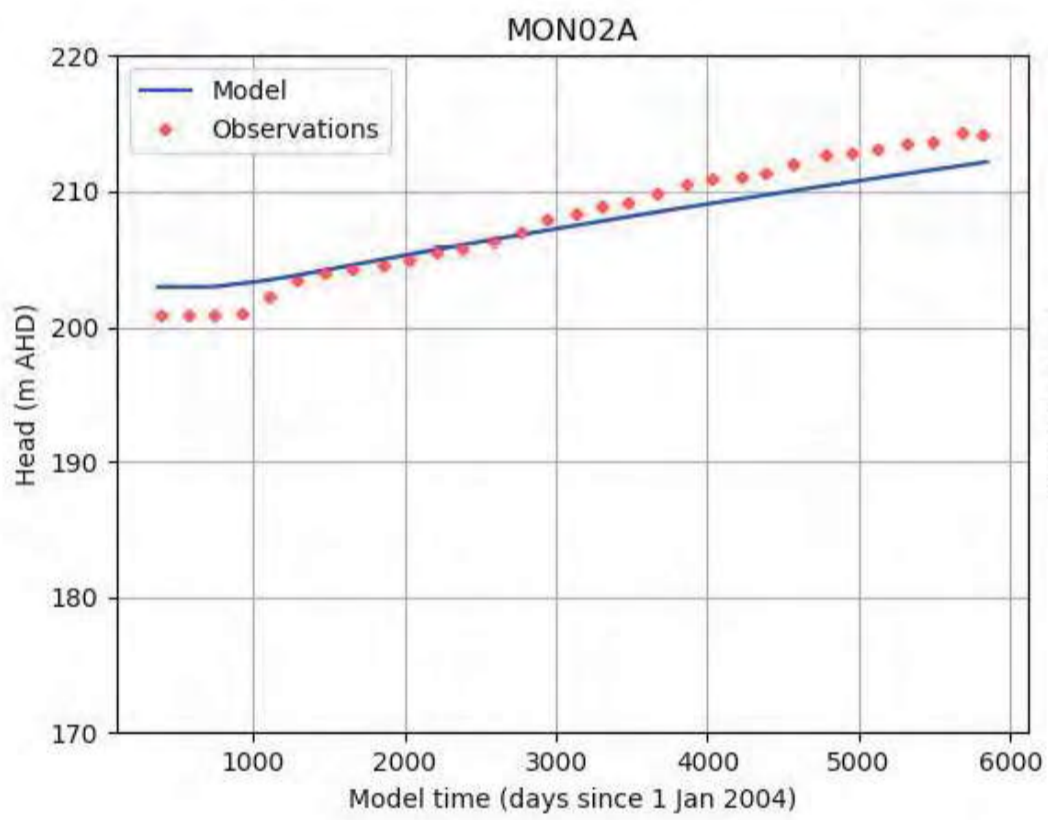
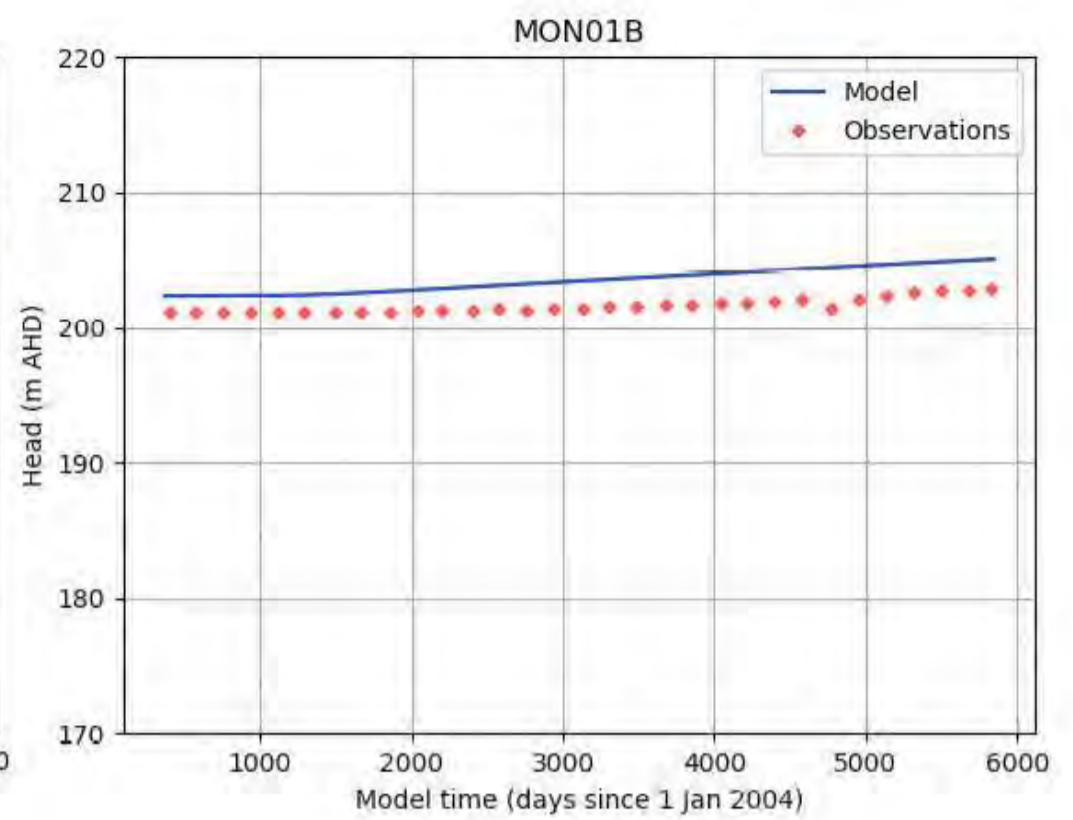
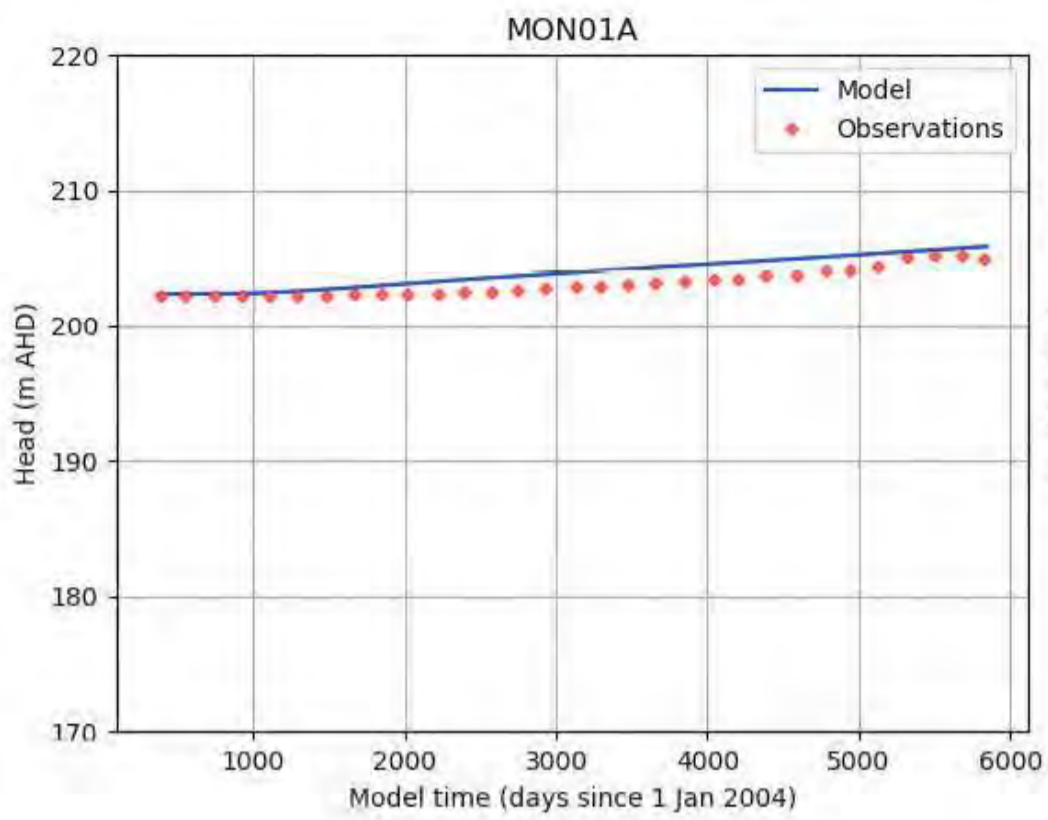

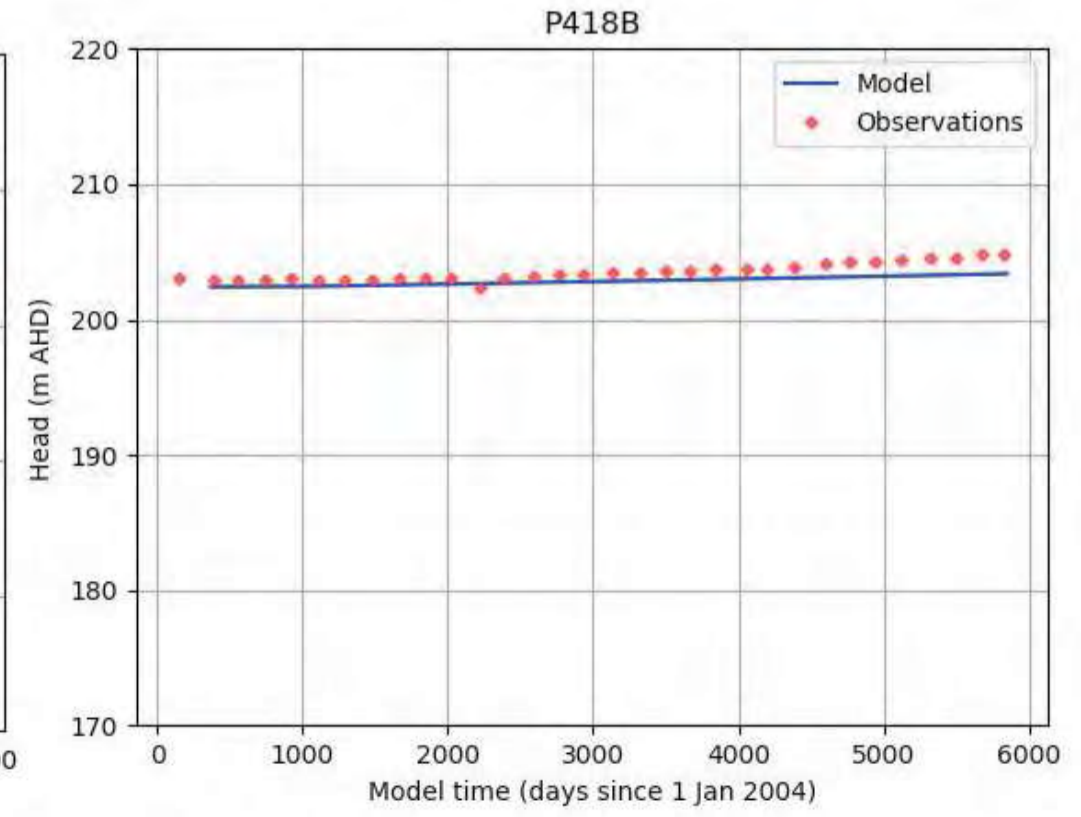
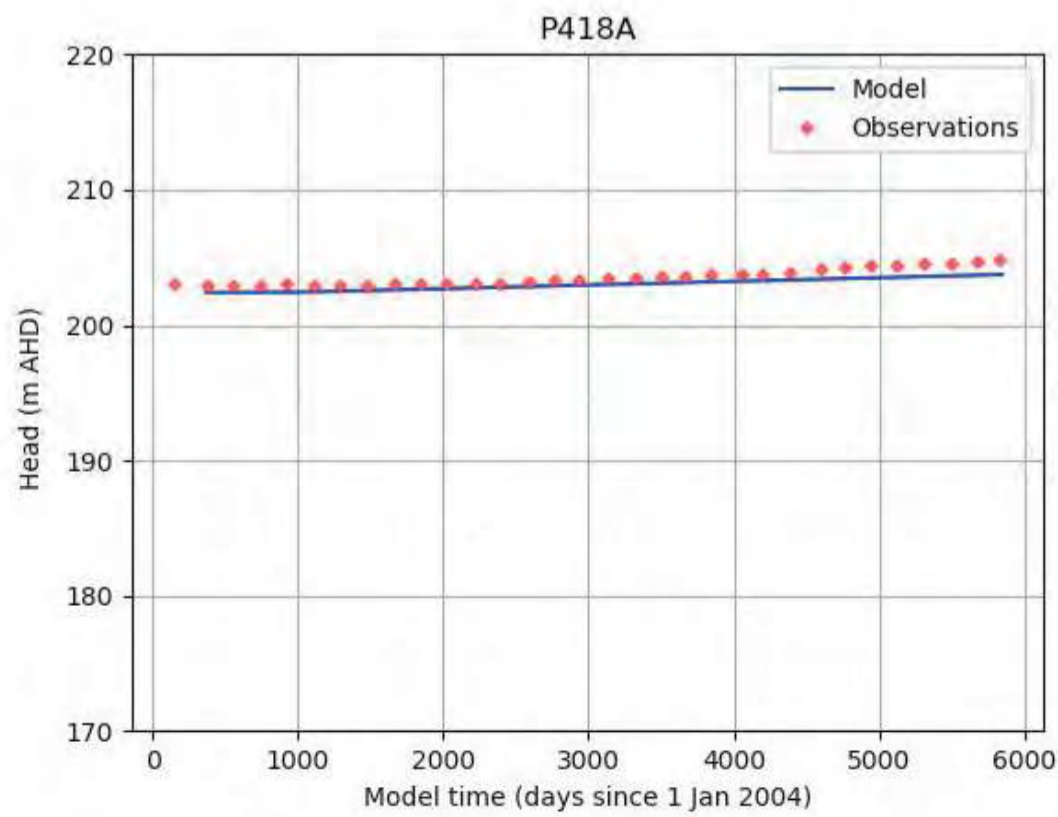
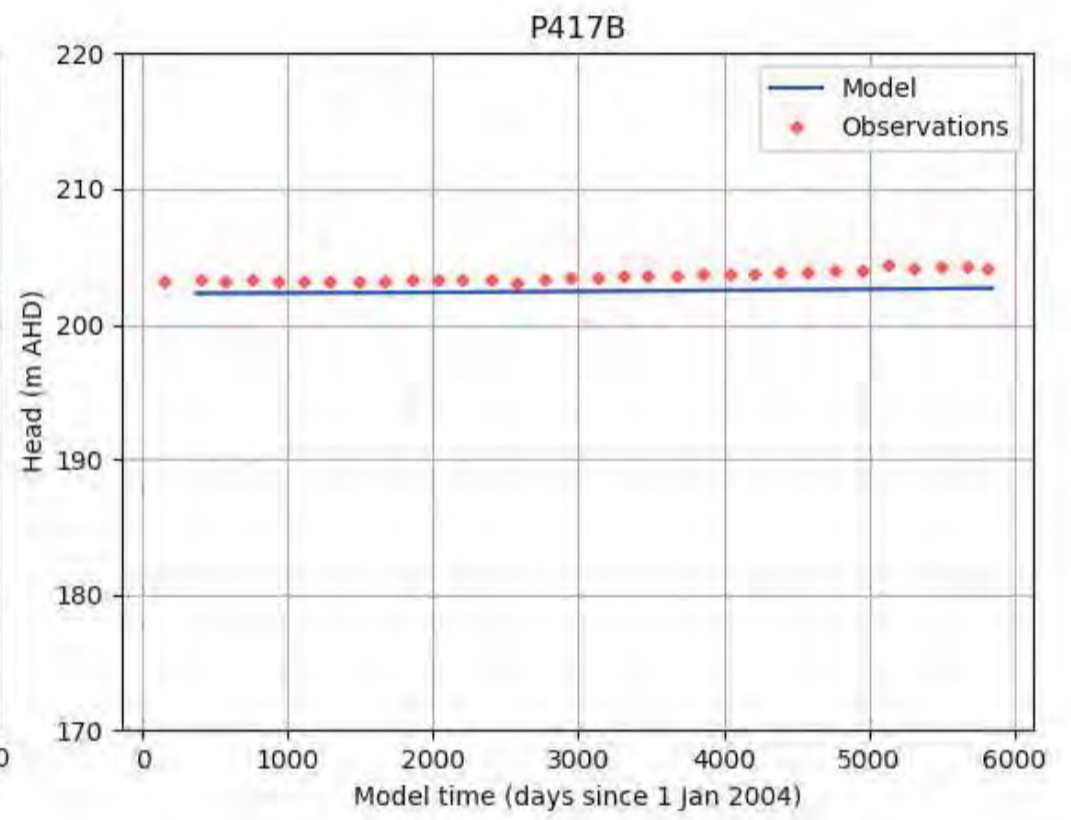
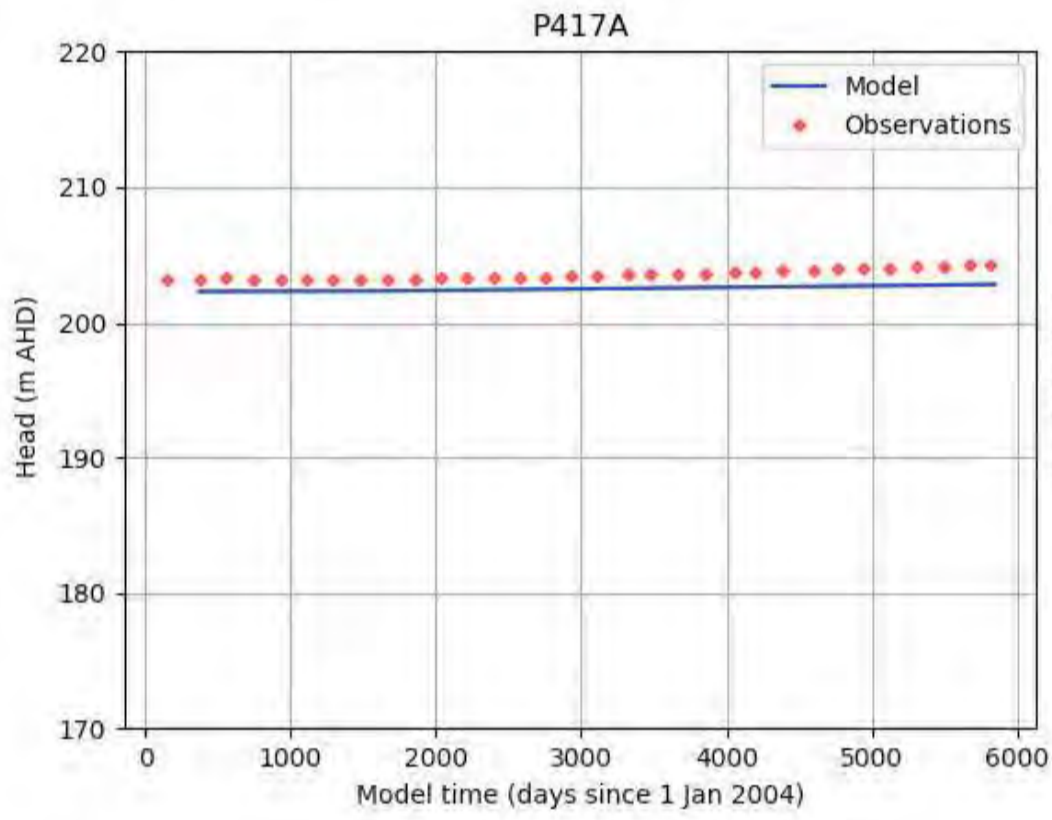
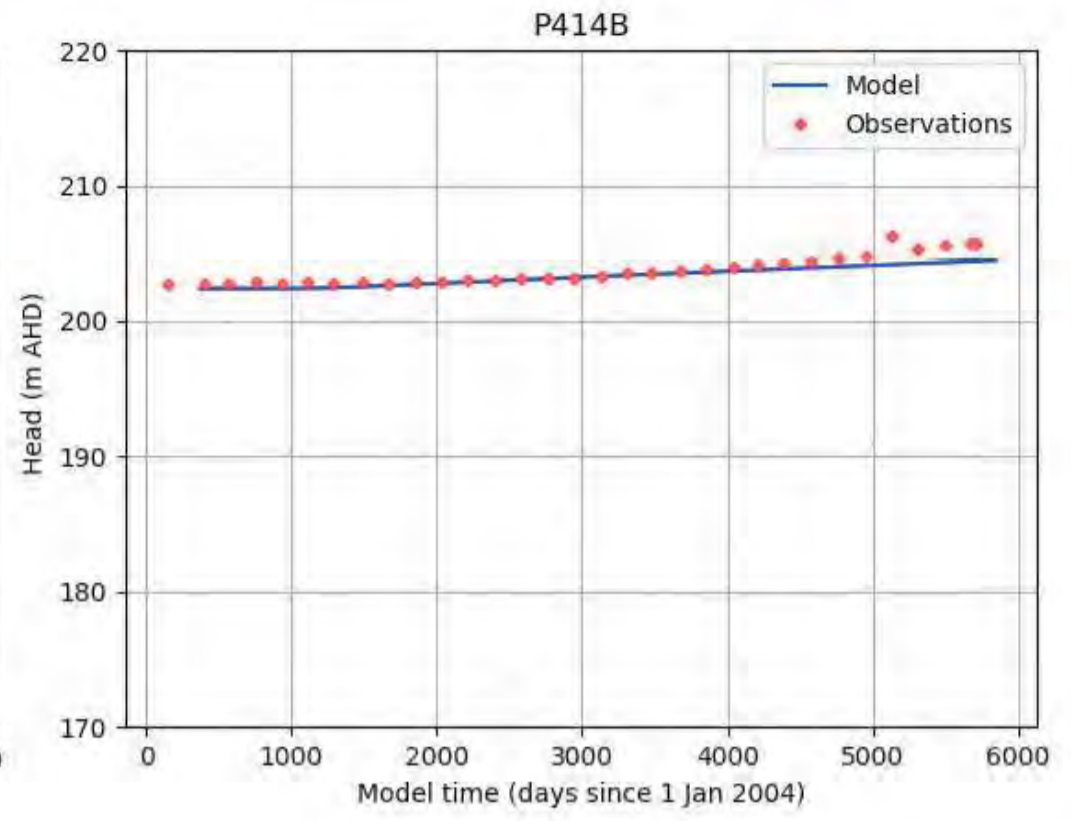
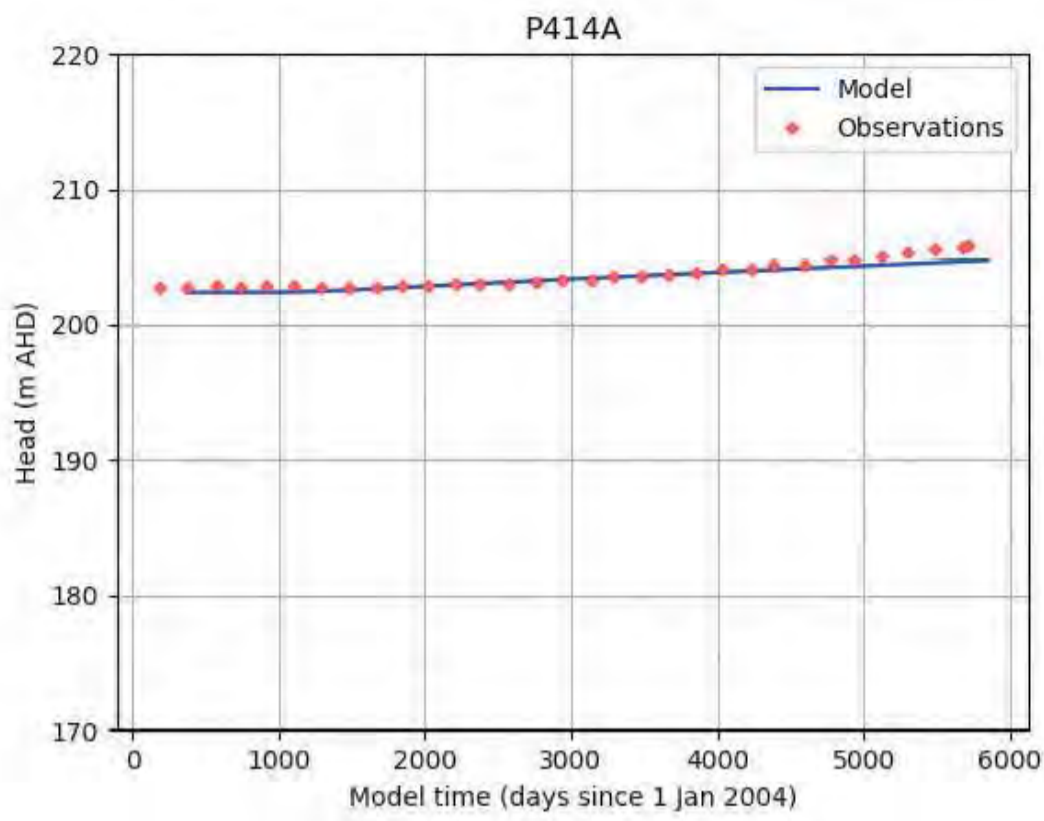

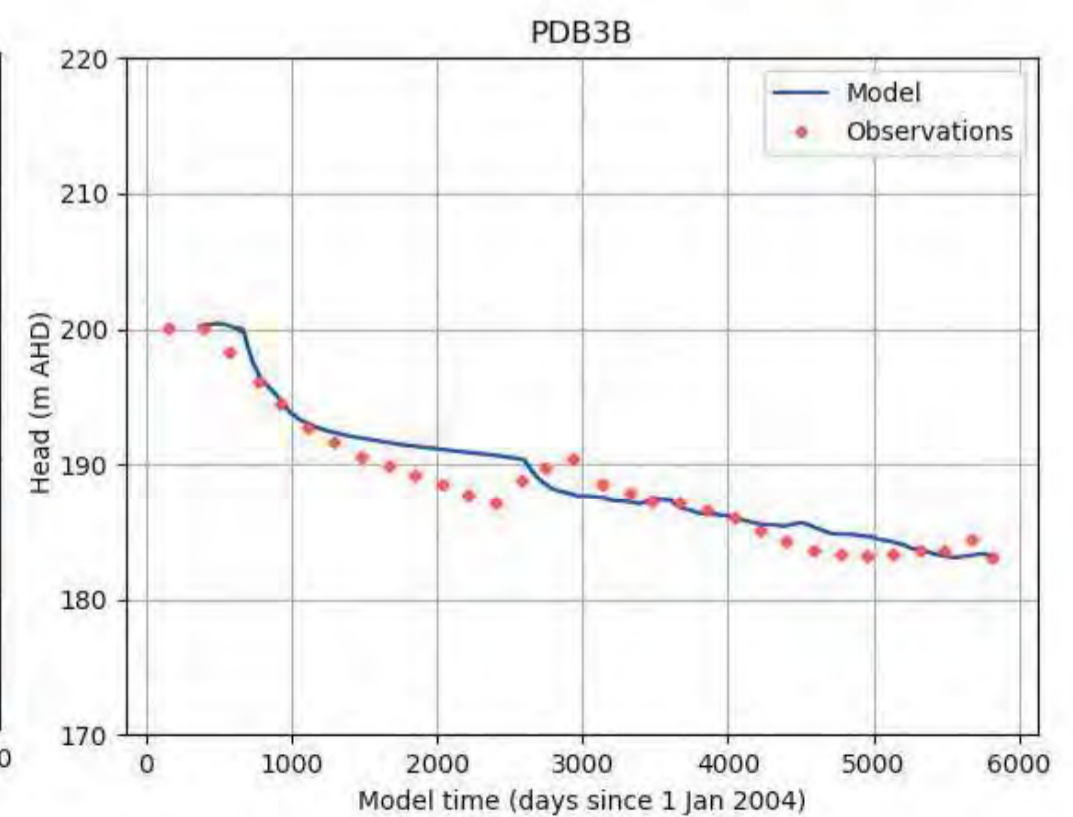
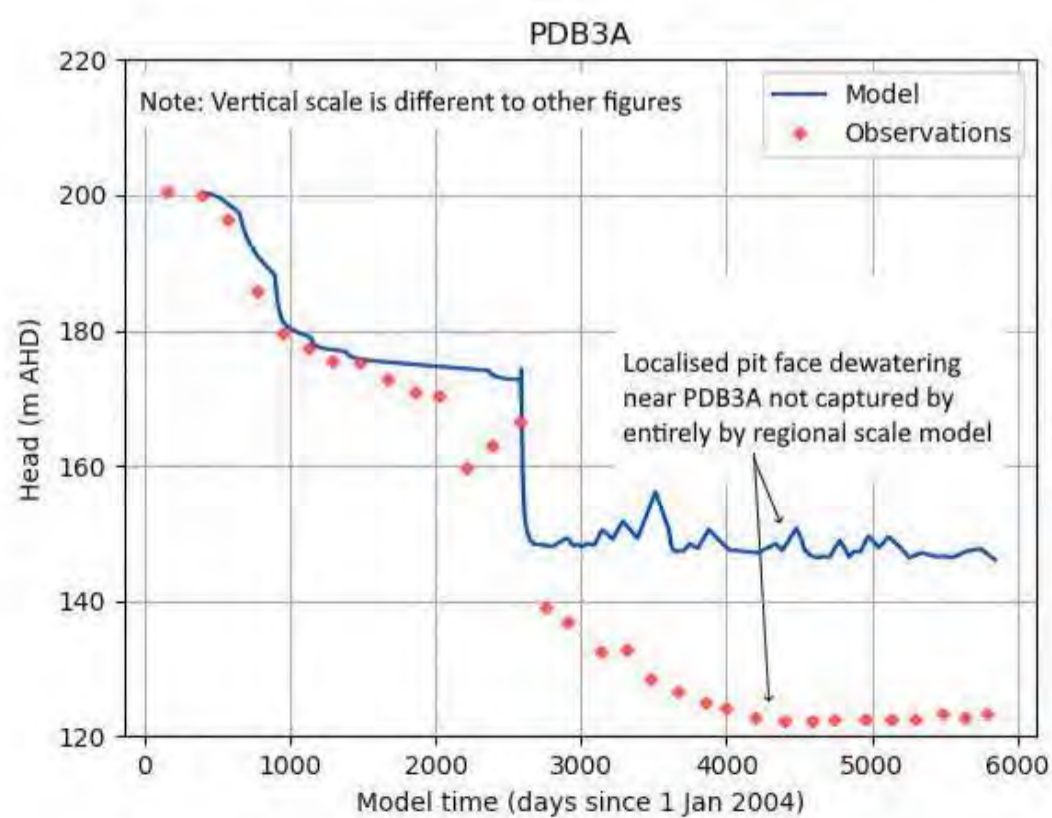
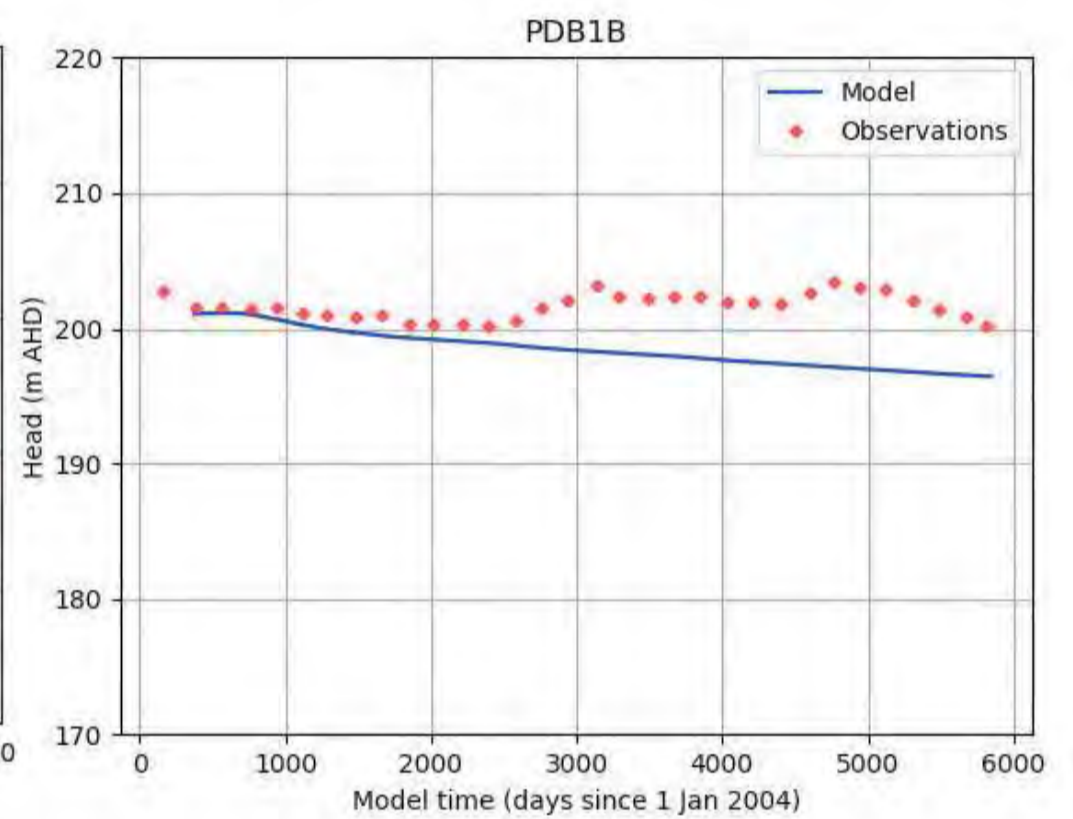
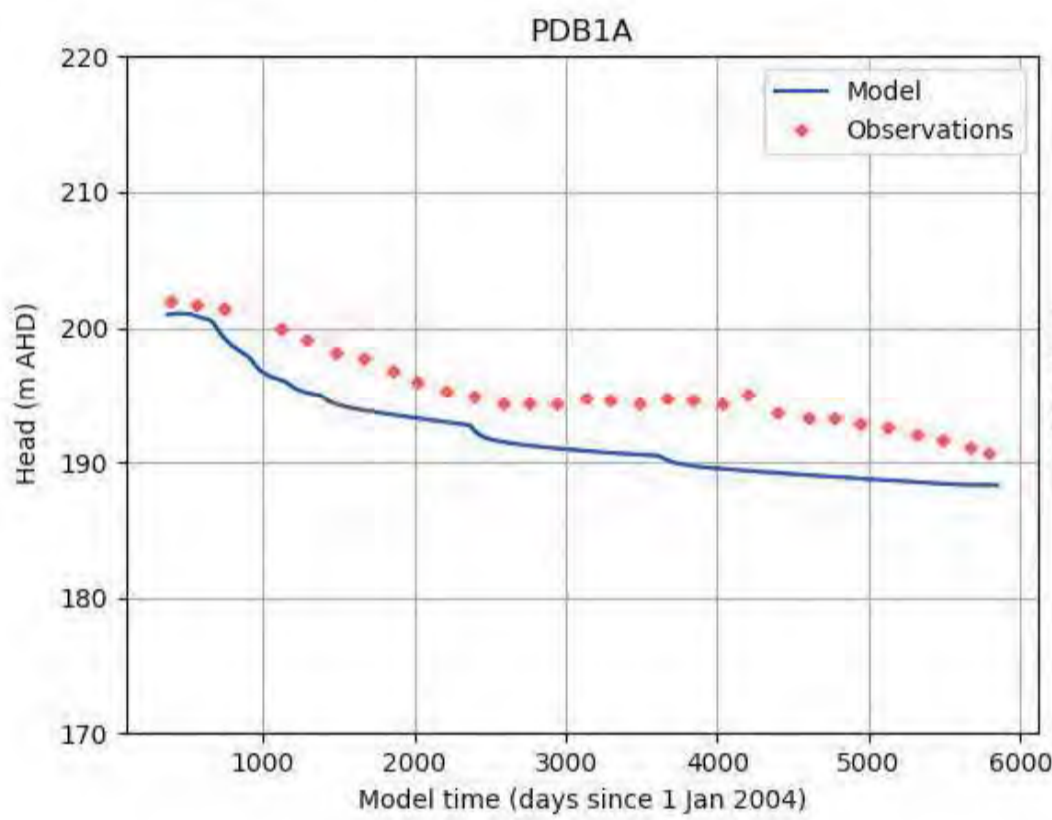
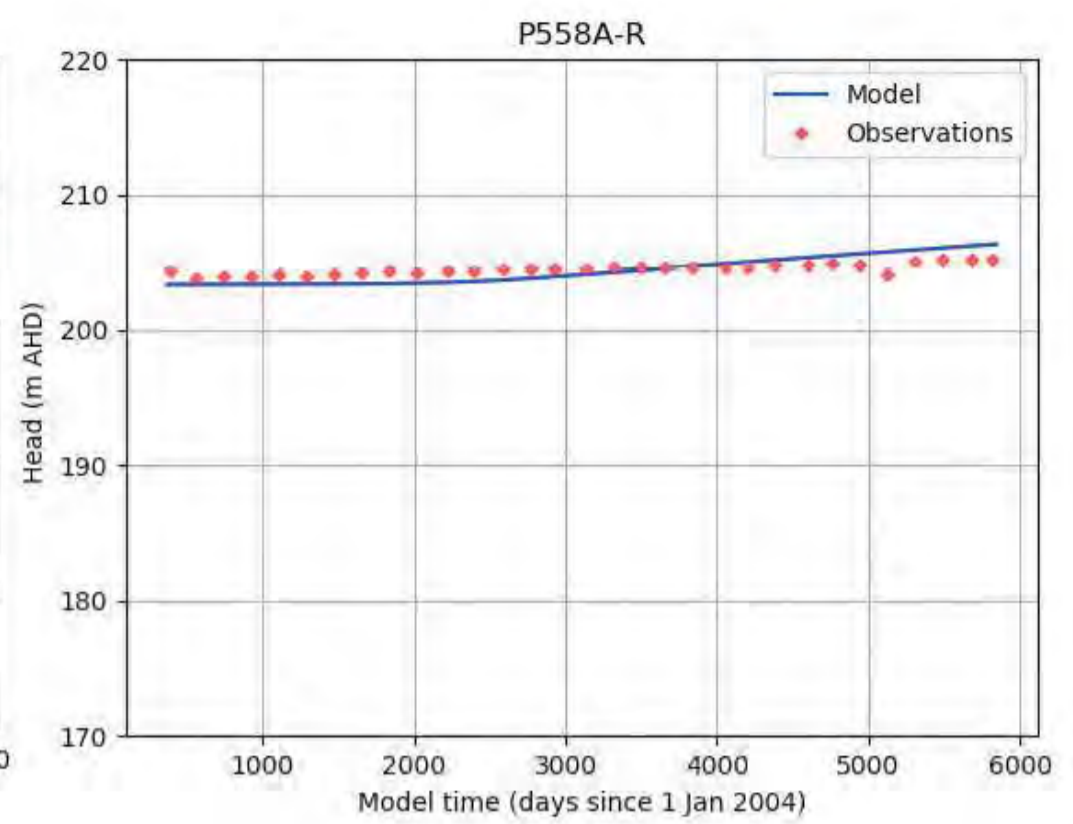
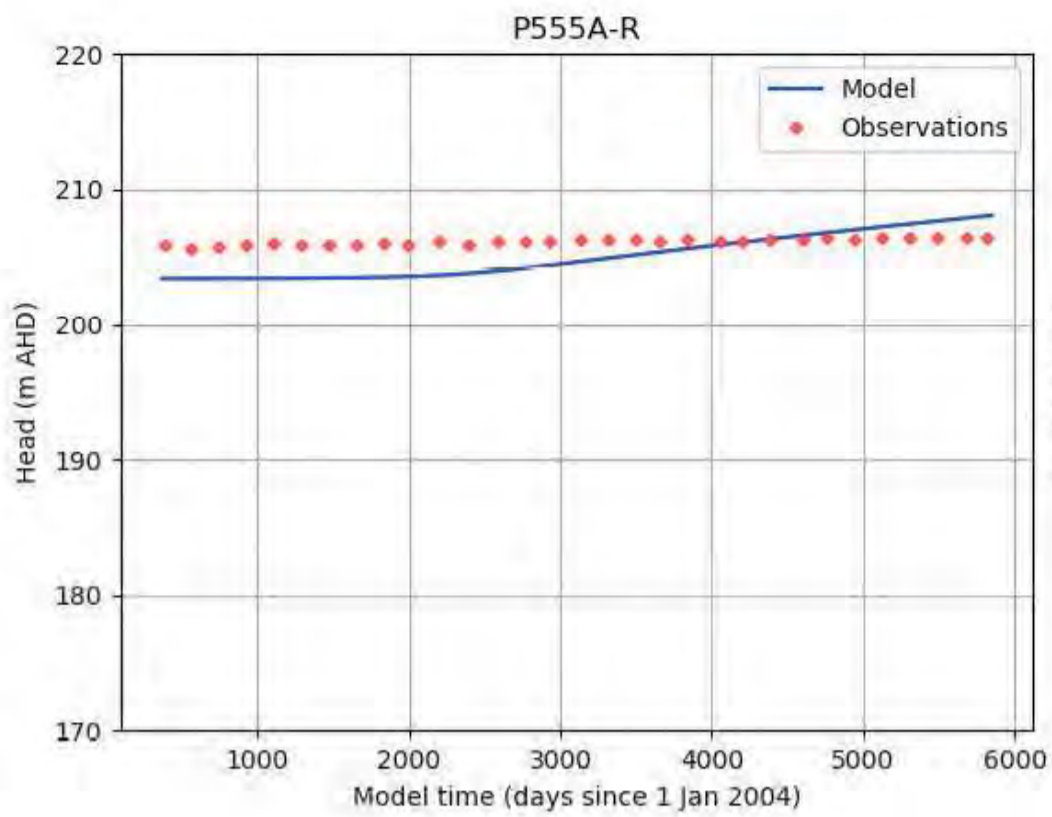

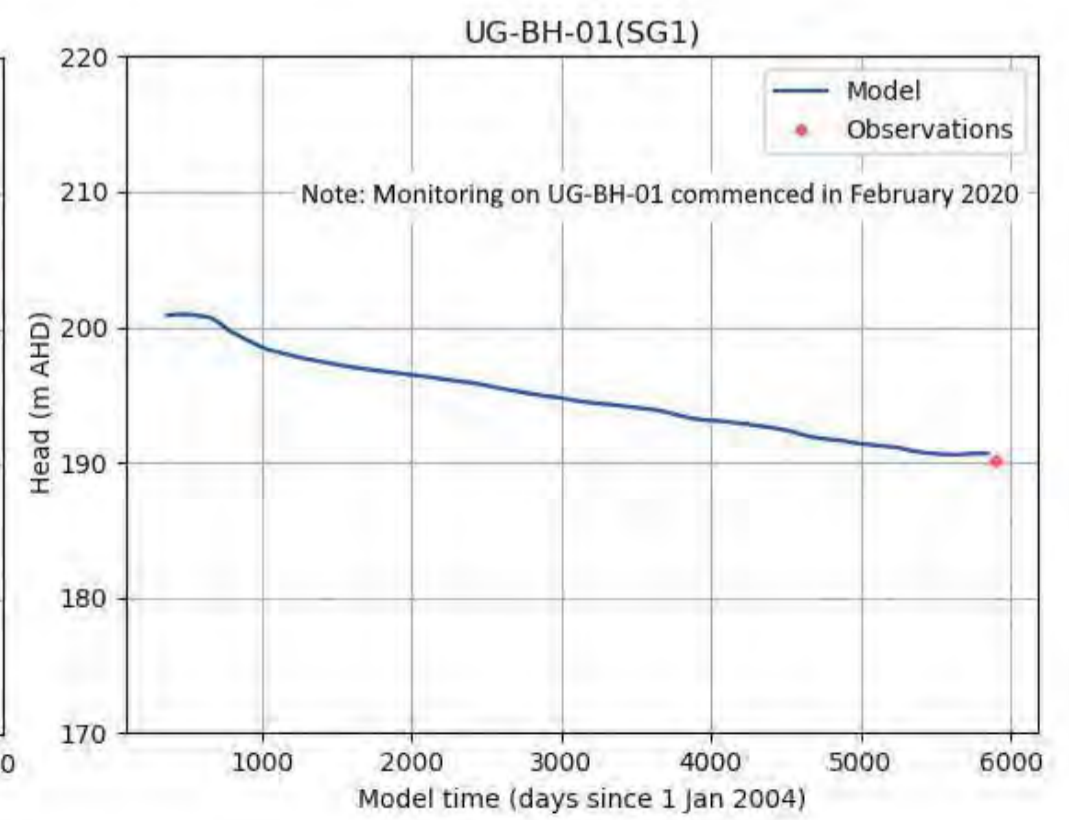
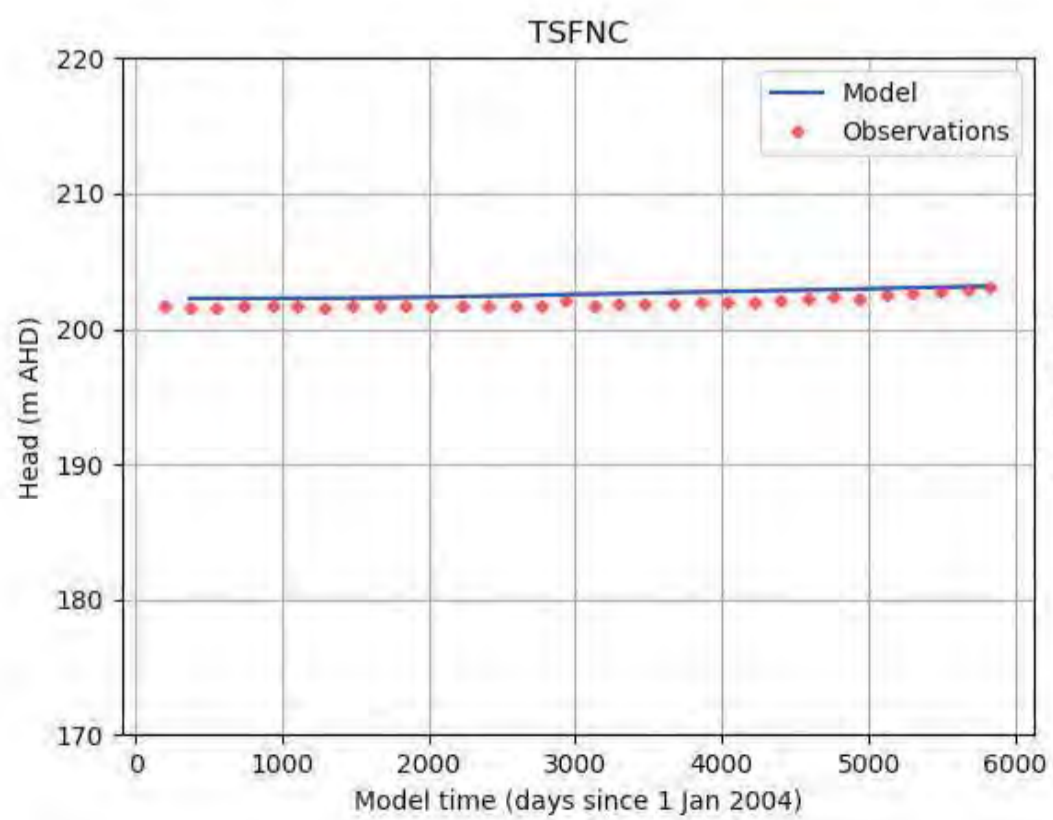
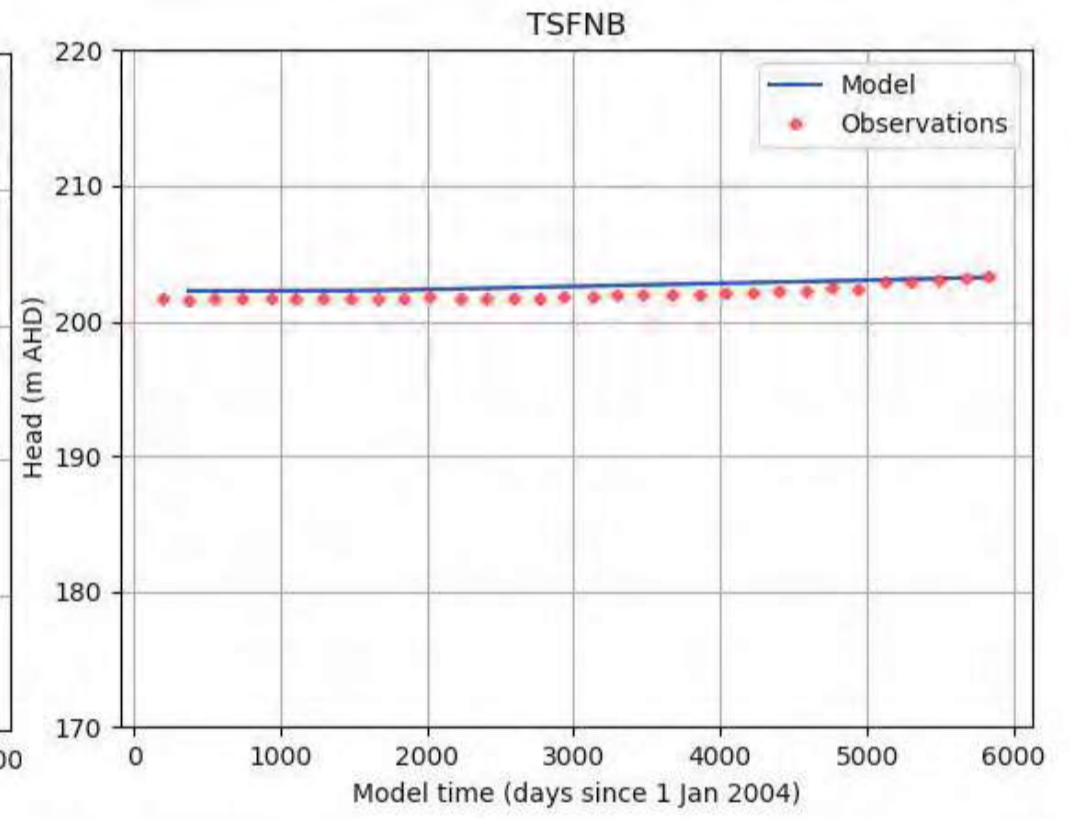
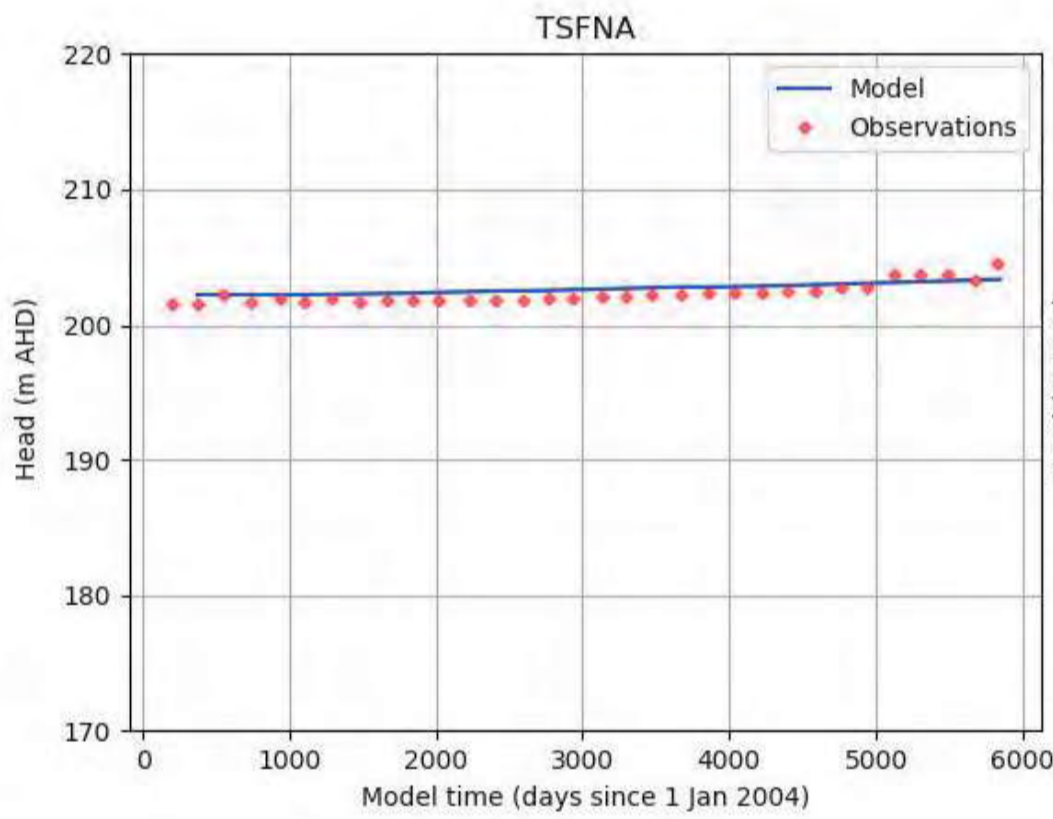
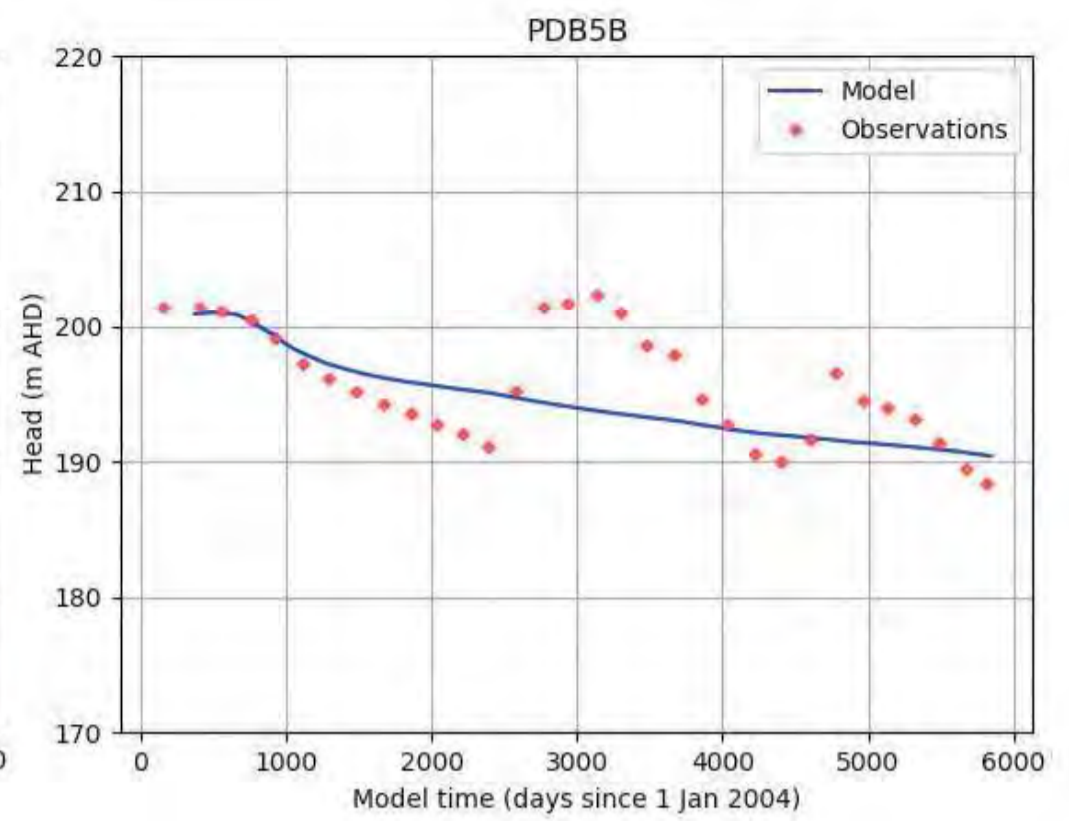
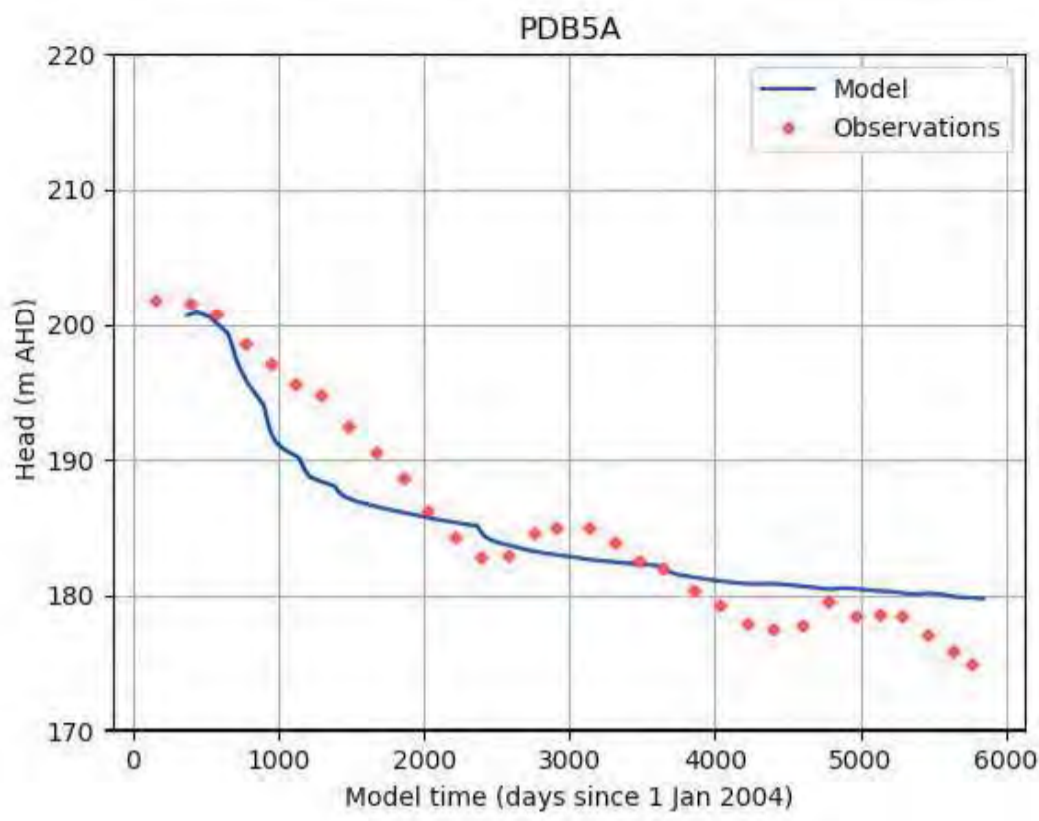

NOTE: Monitoring on UG-BH-01 and UG-BH-02 commenced in February 2020

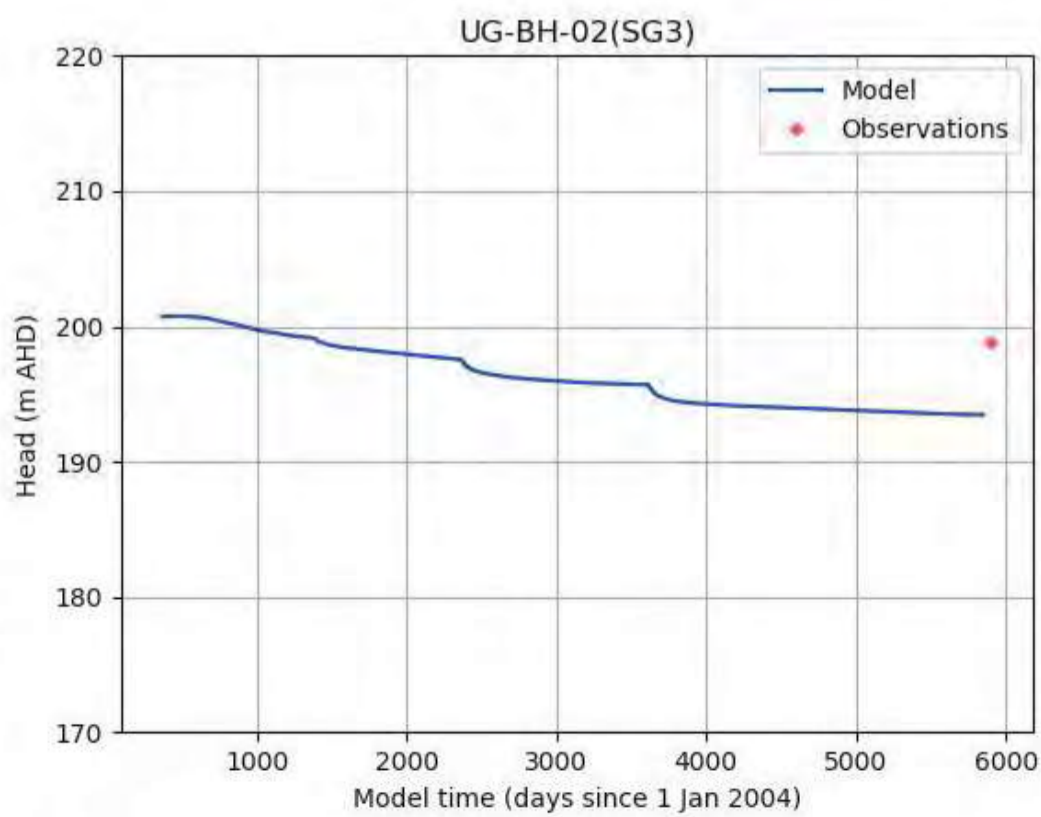
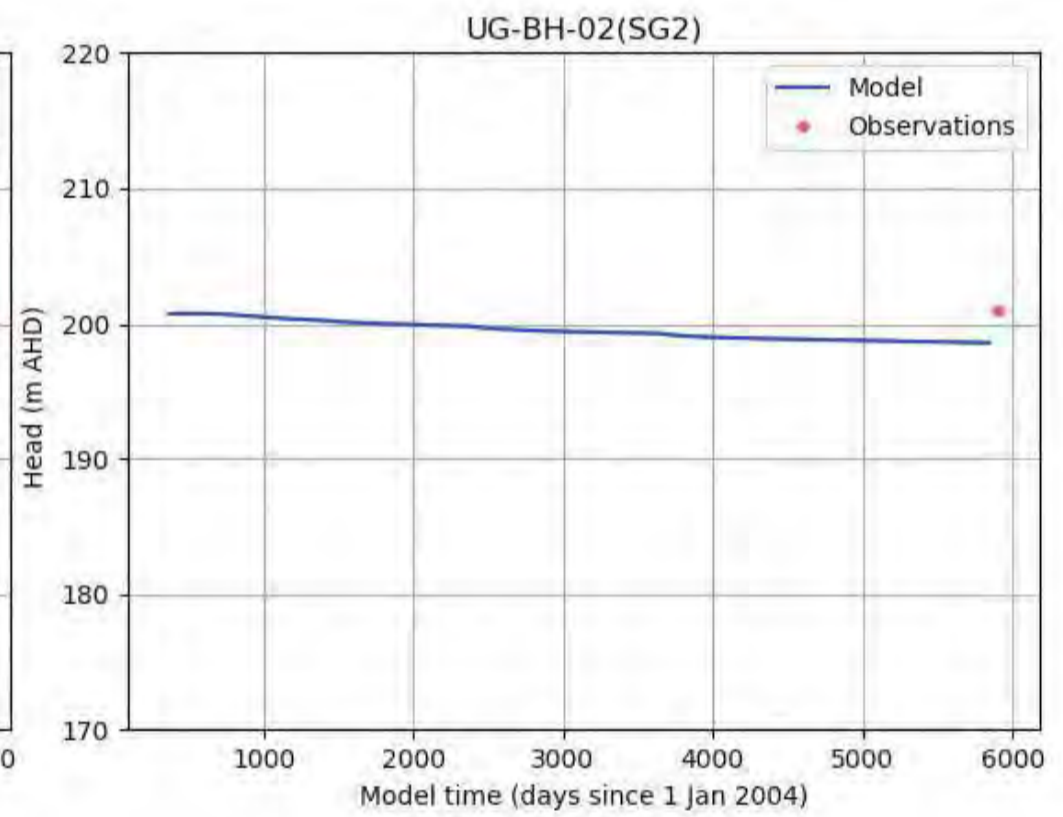
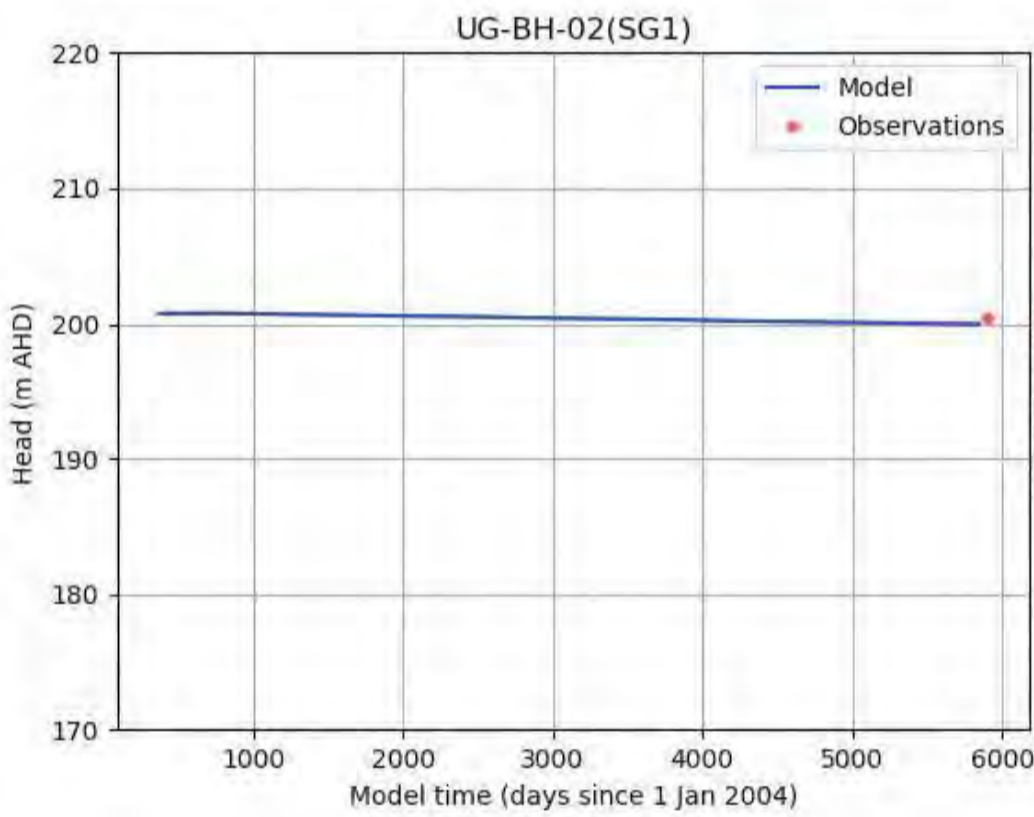
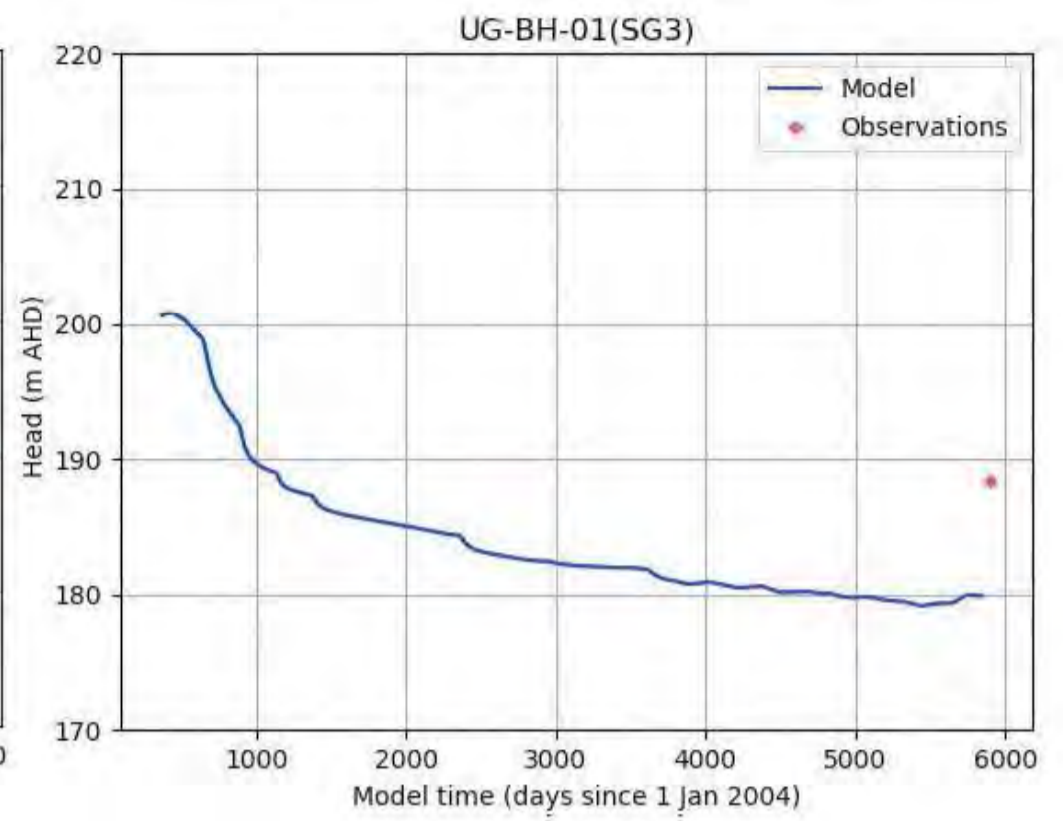
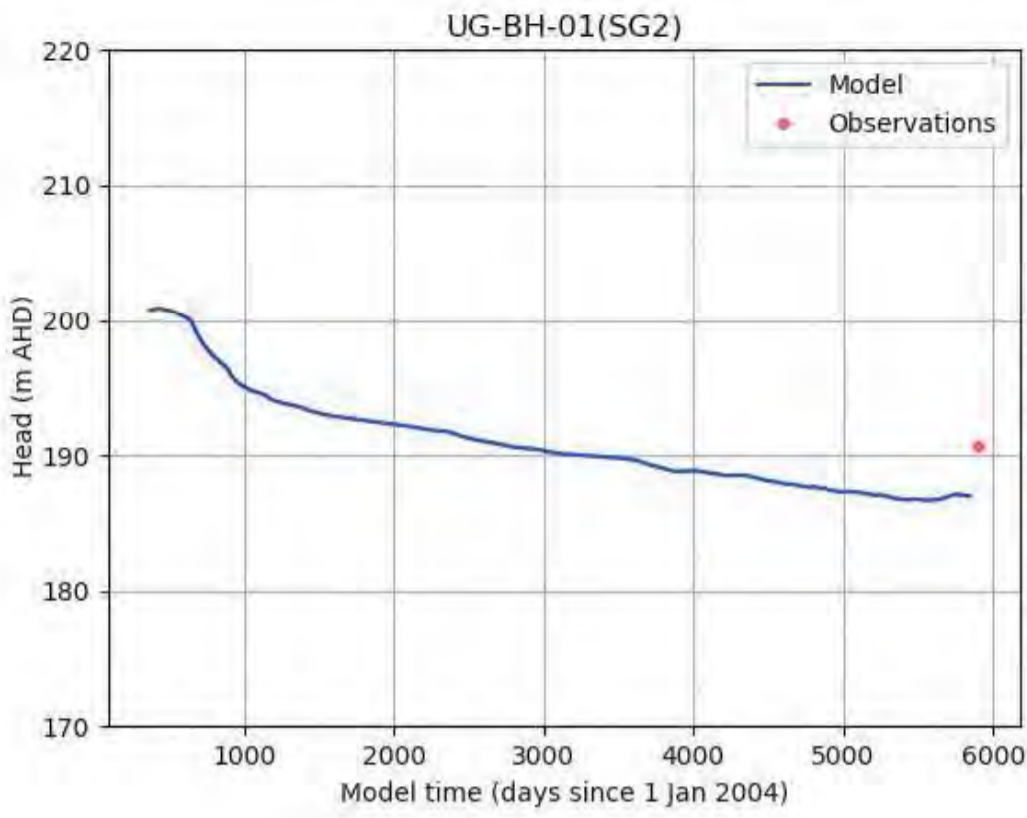

Appendix C - Groundwater level response

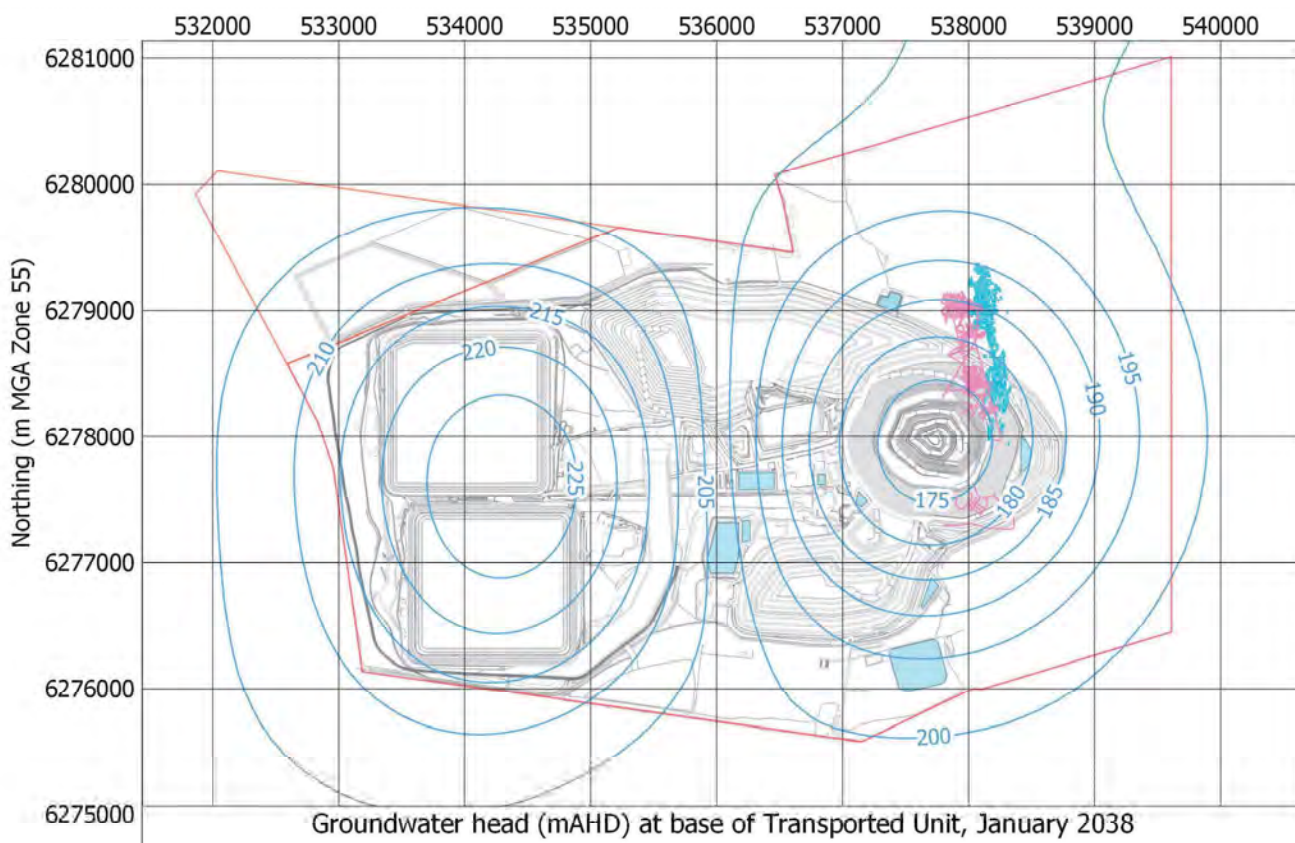
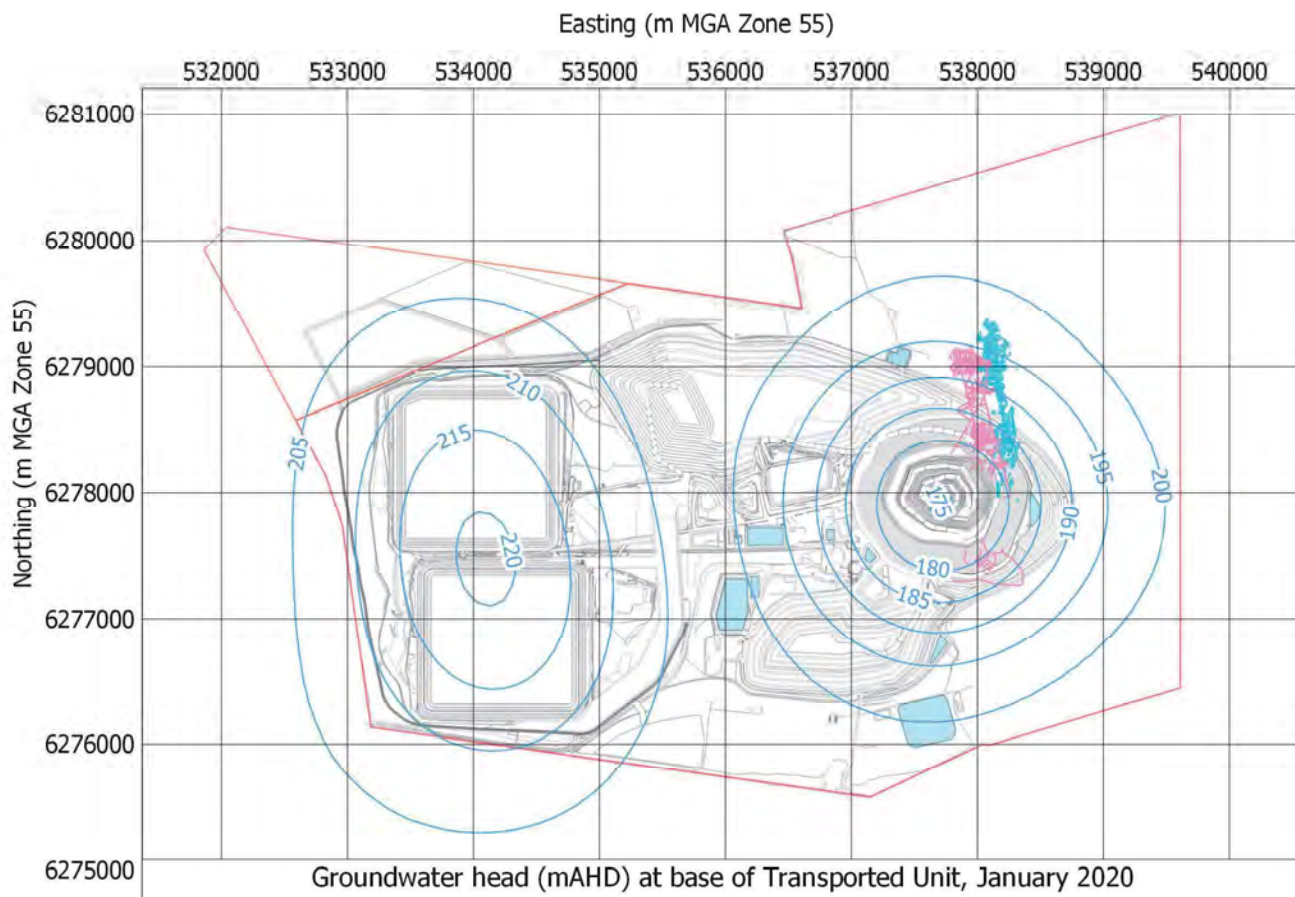

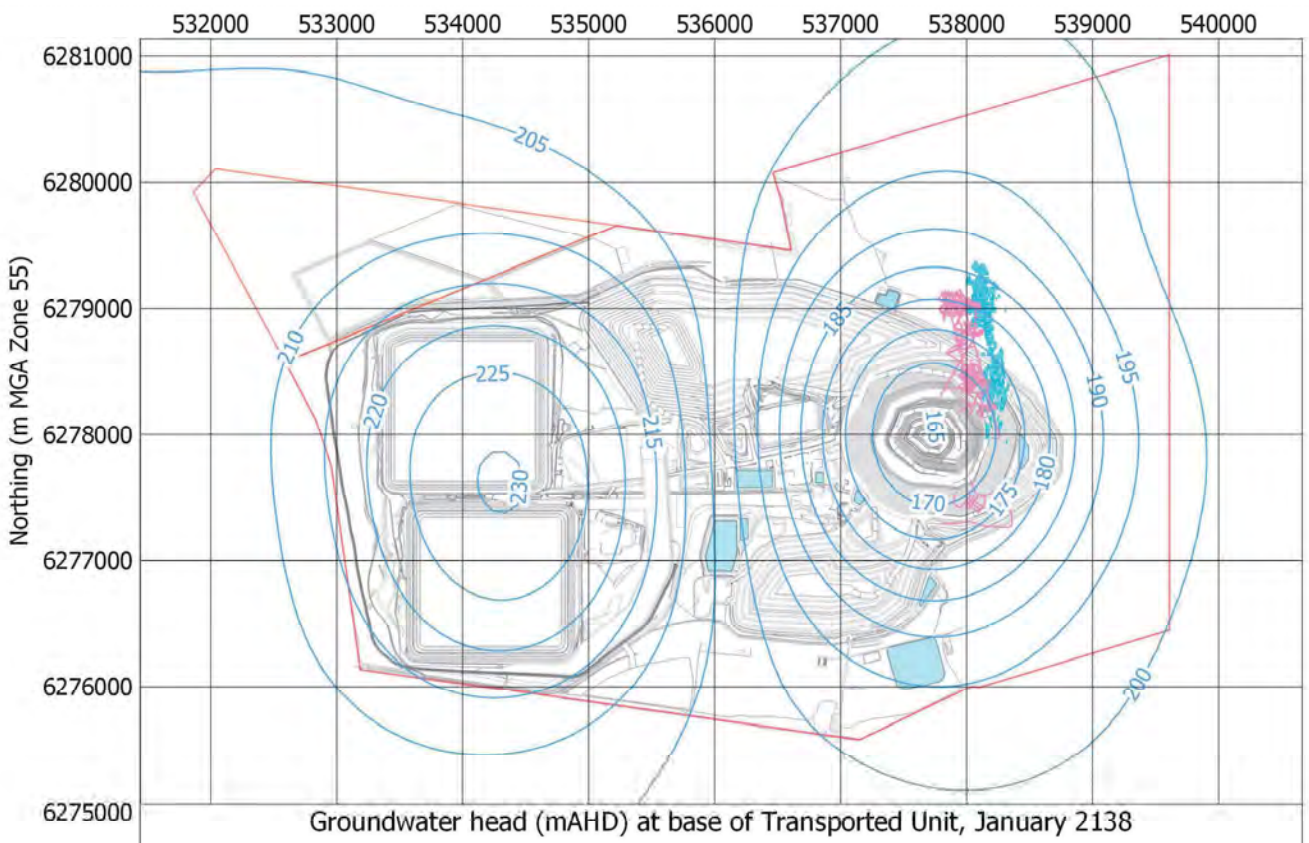
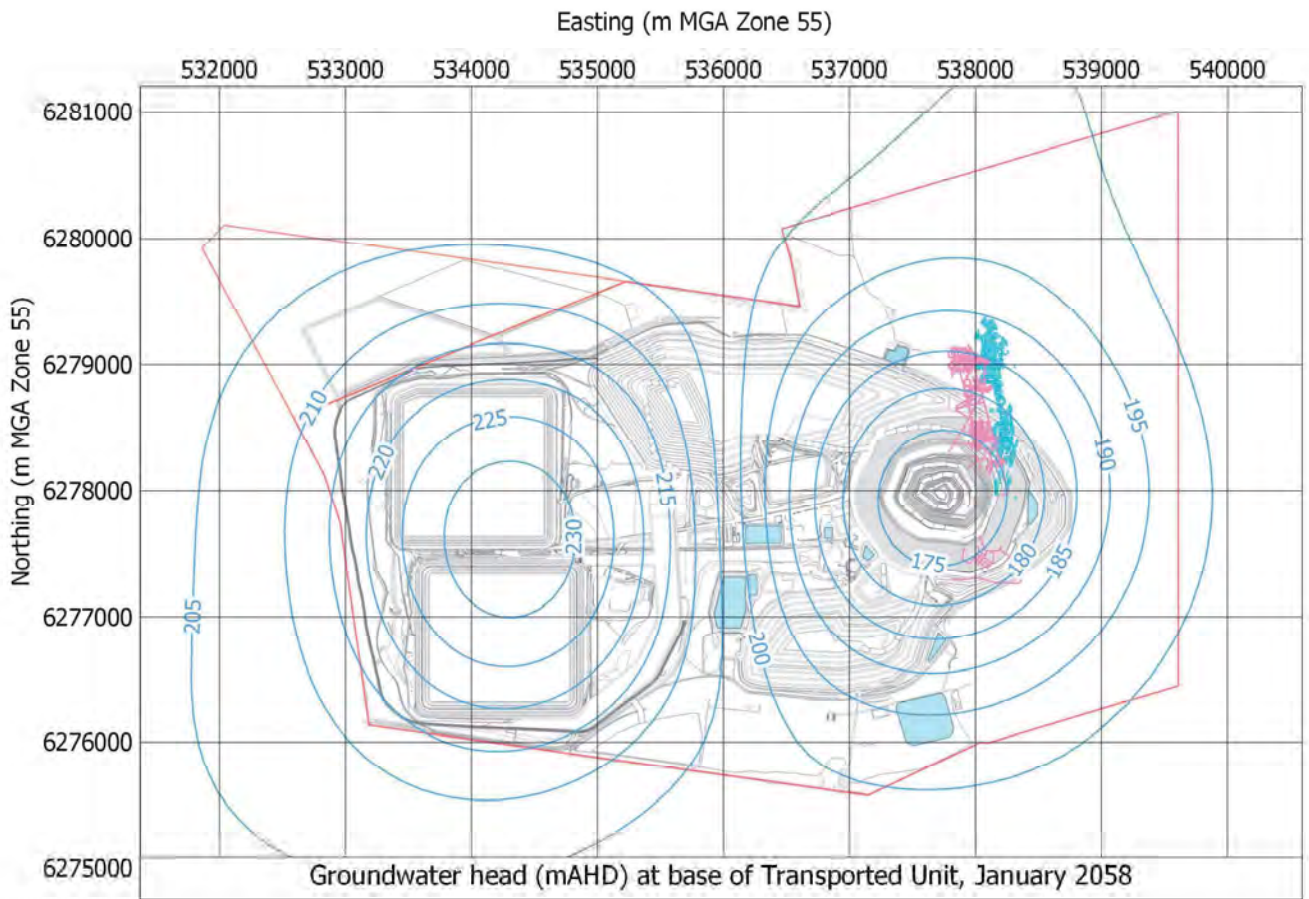

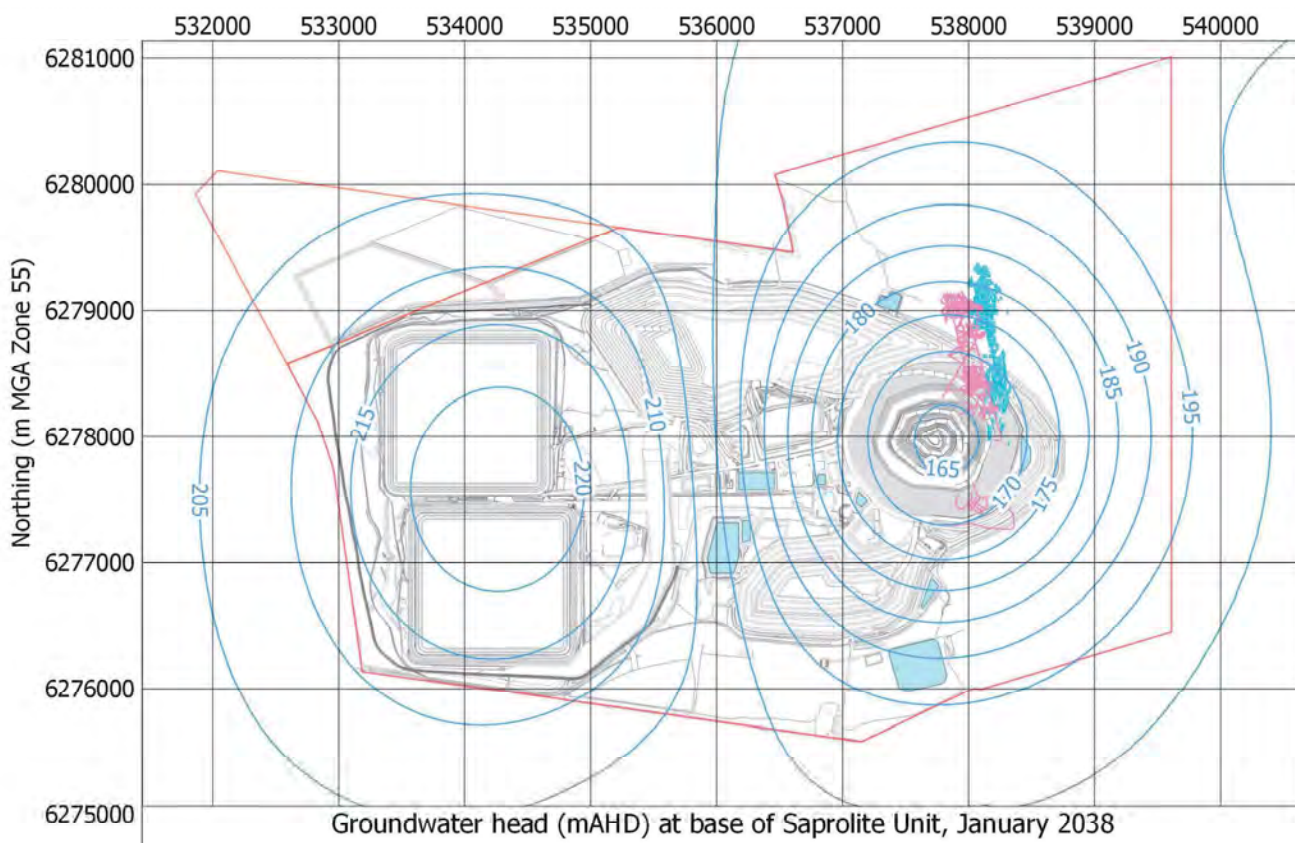
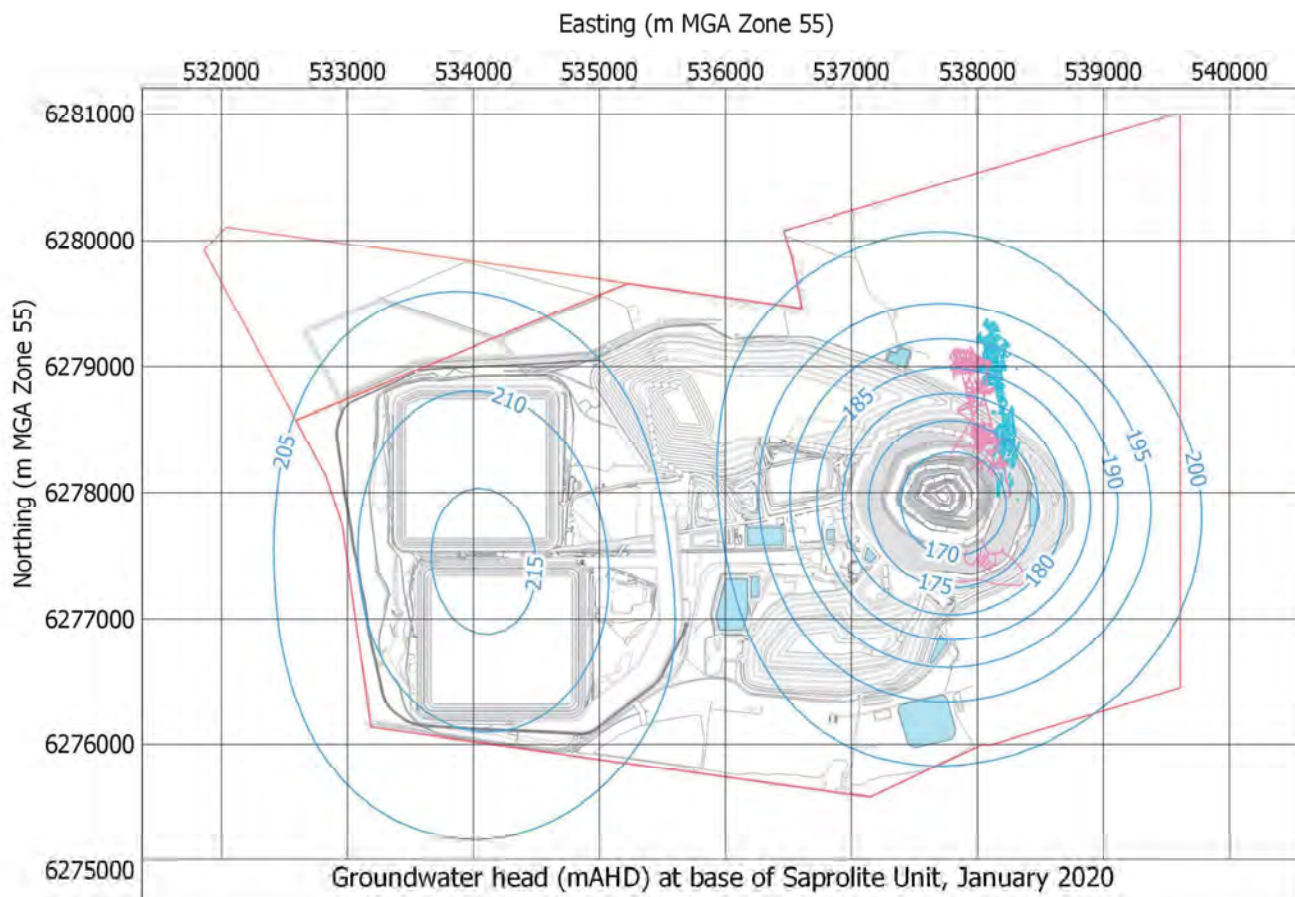

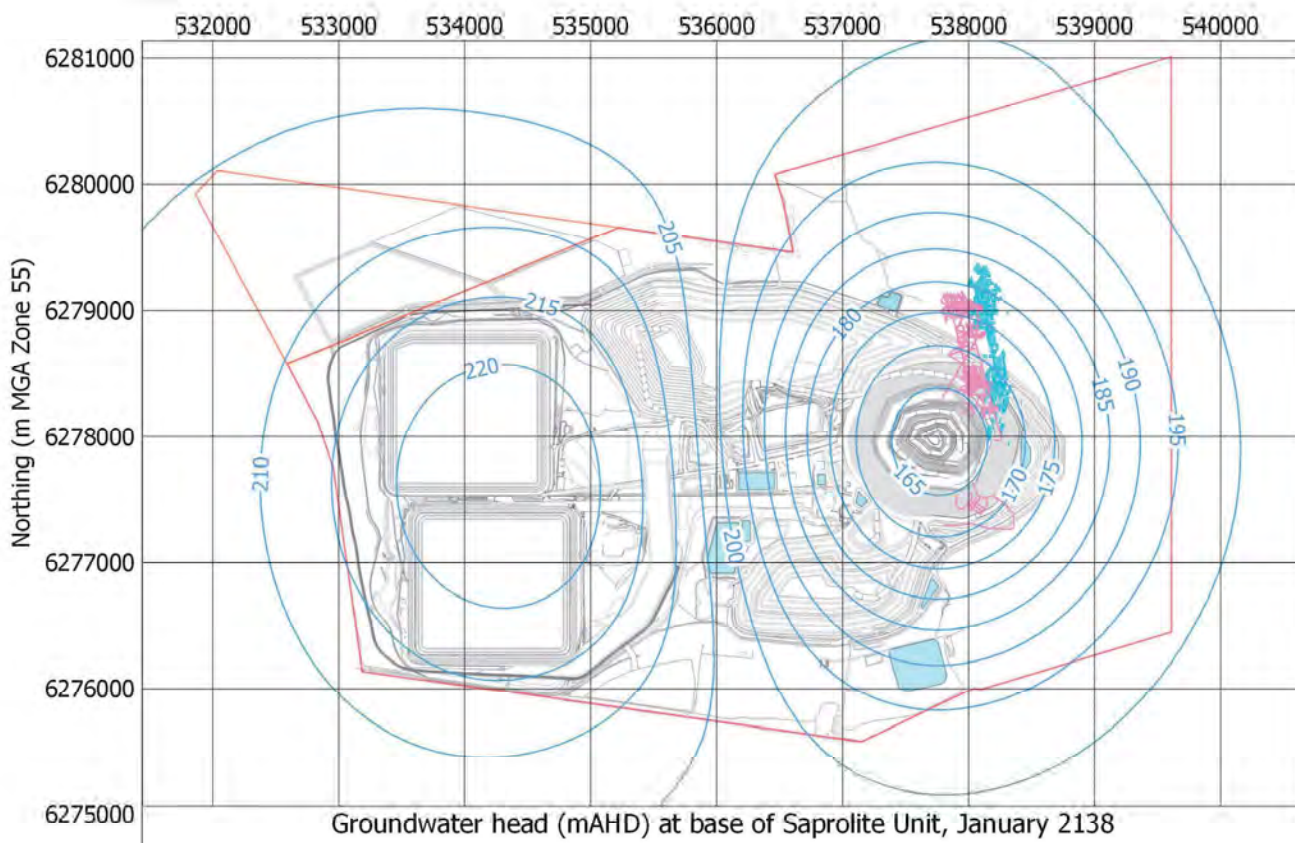
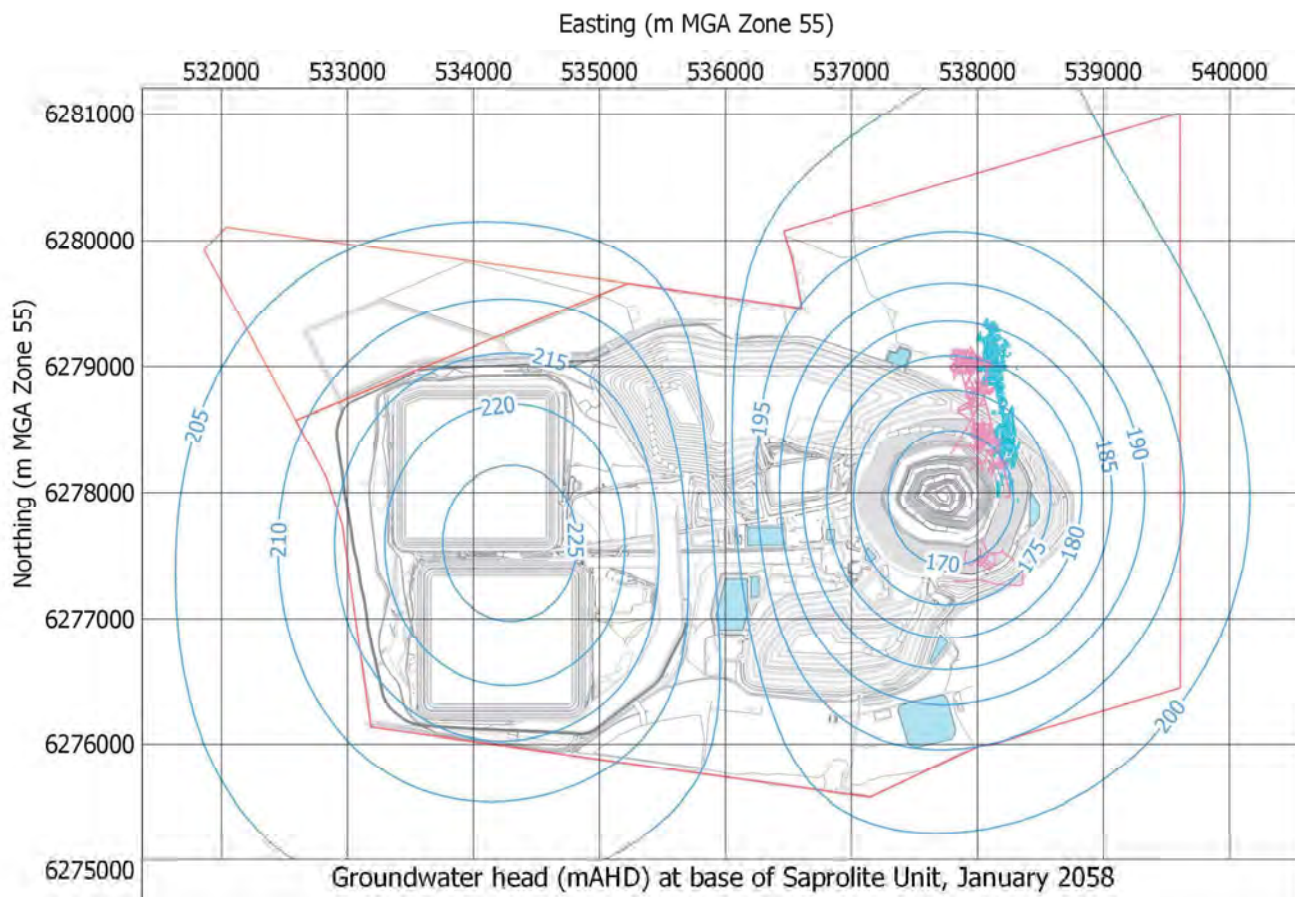

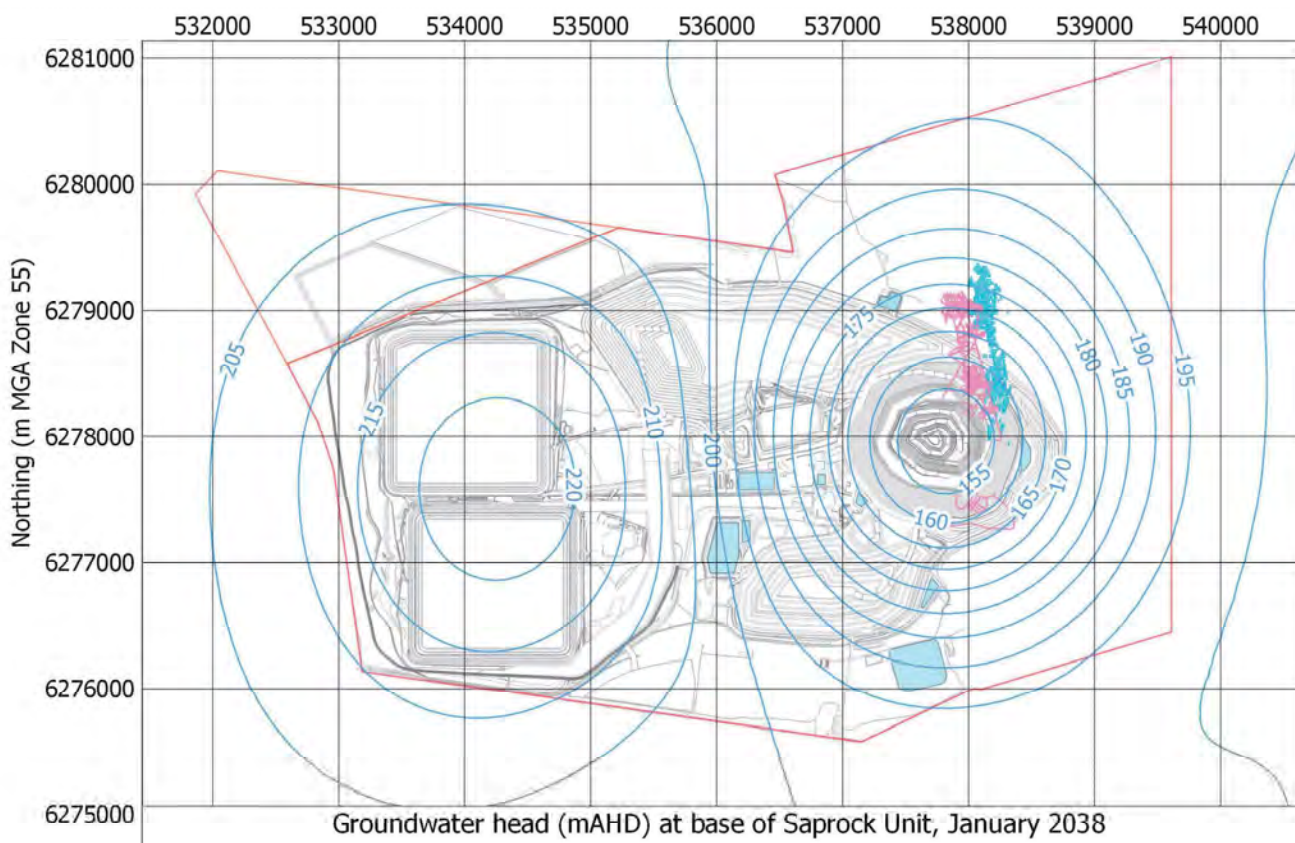
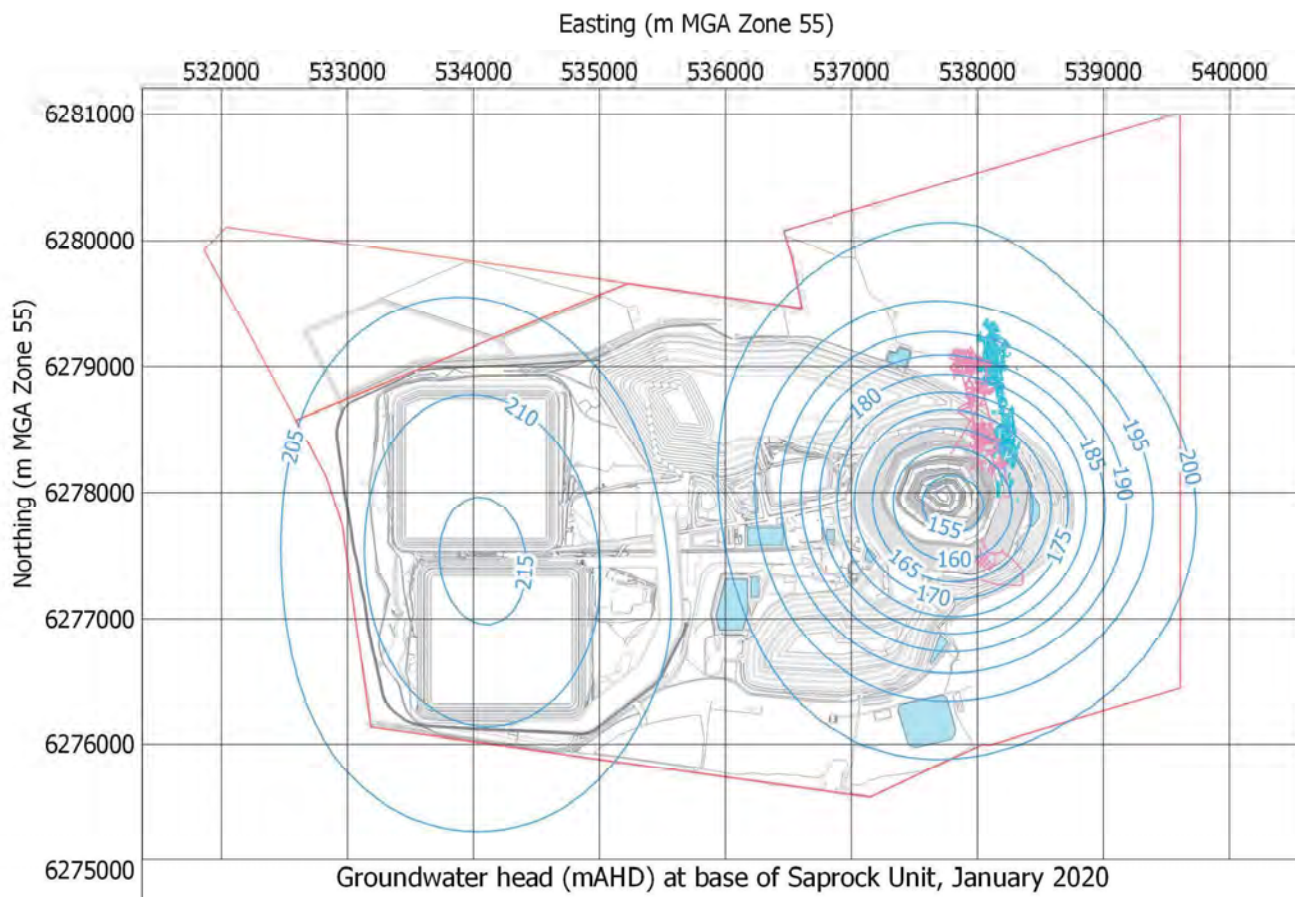

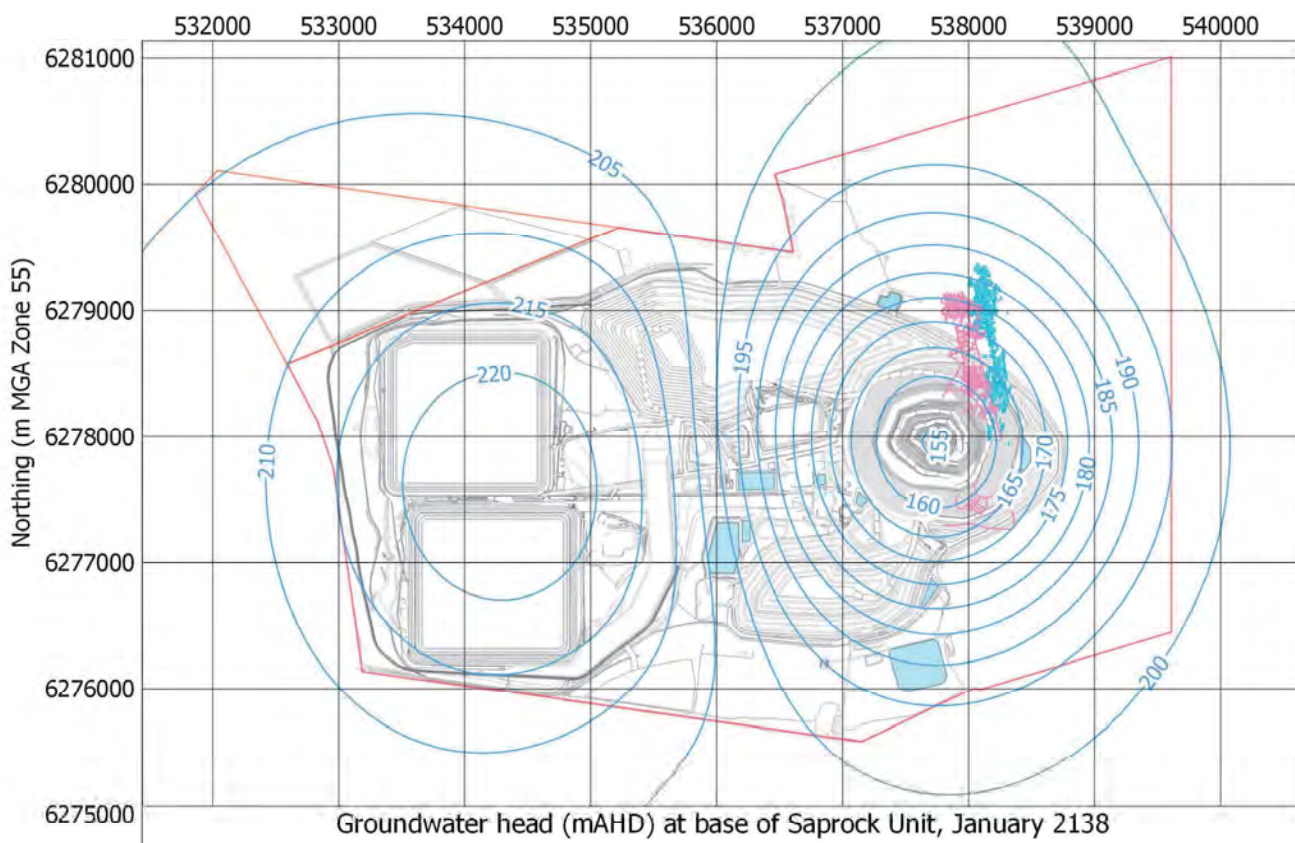
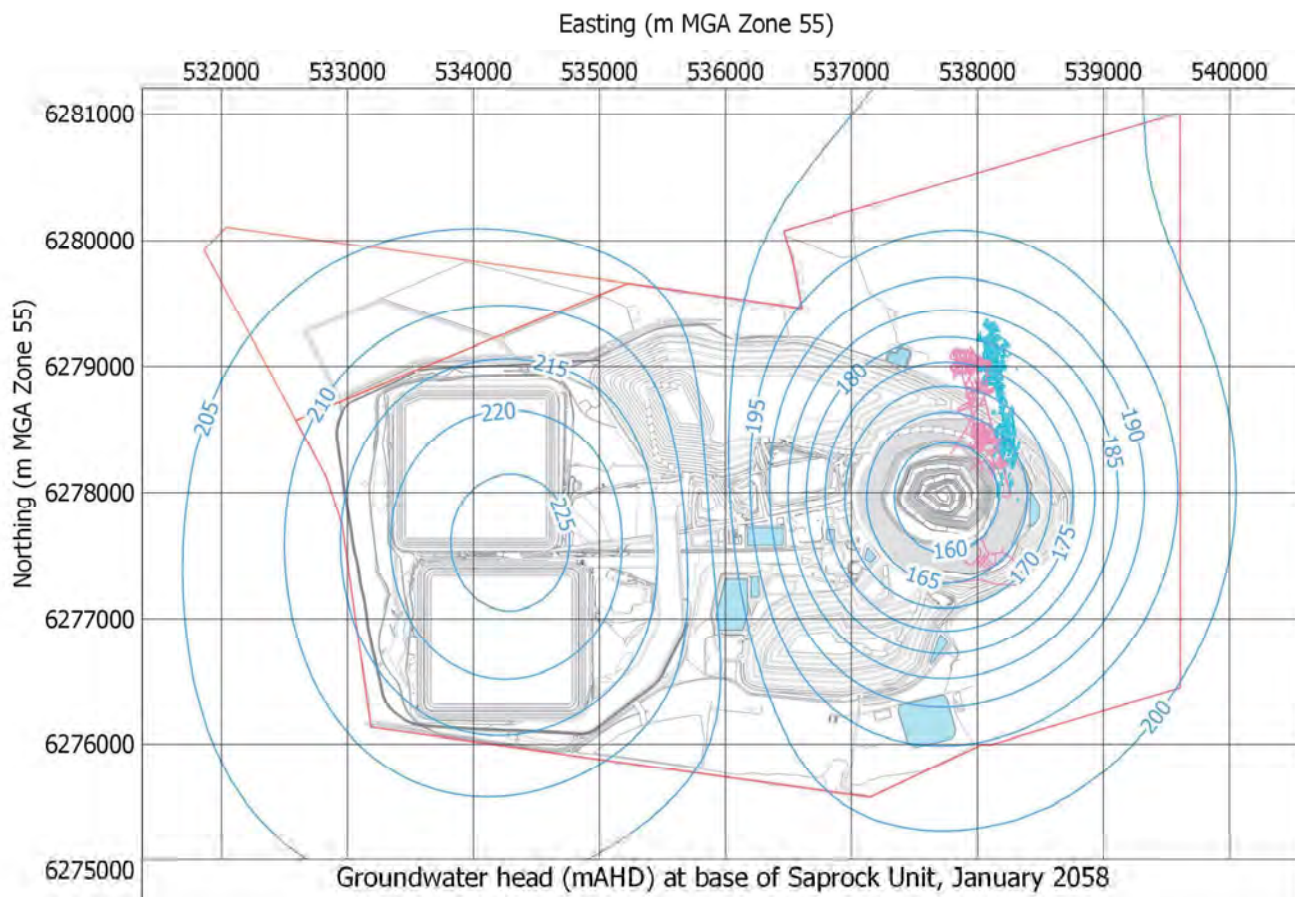

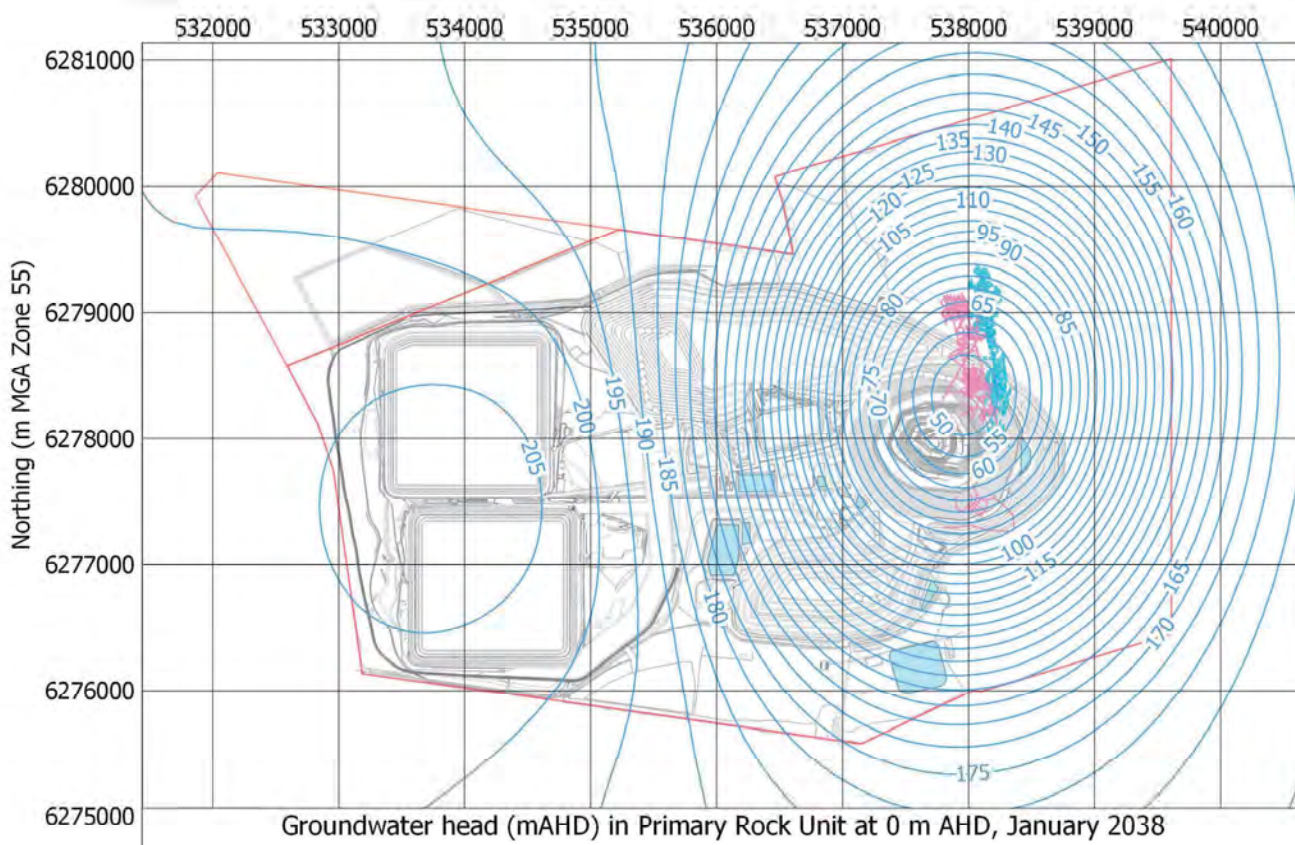
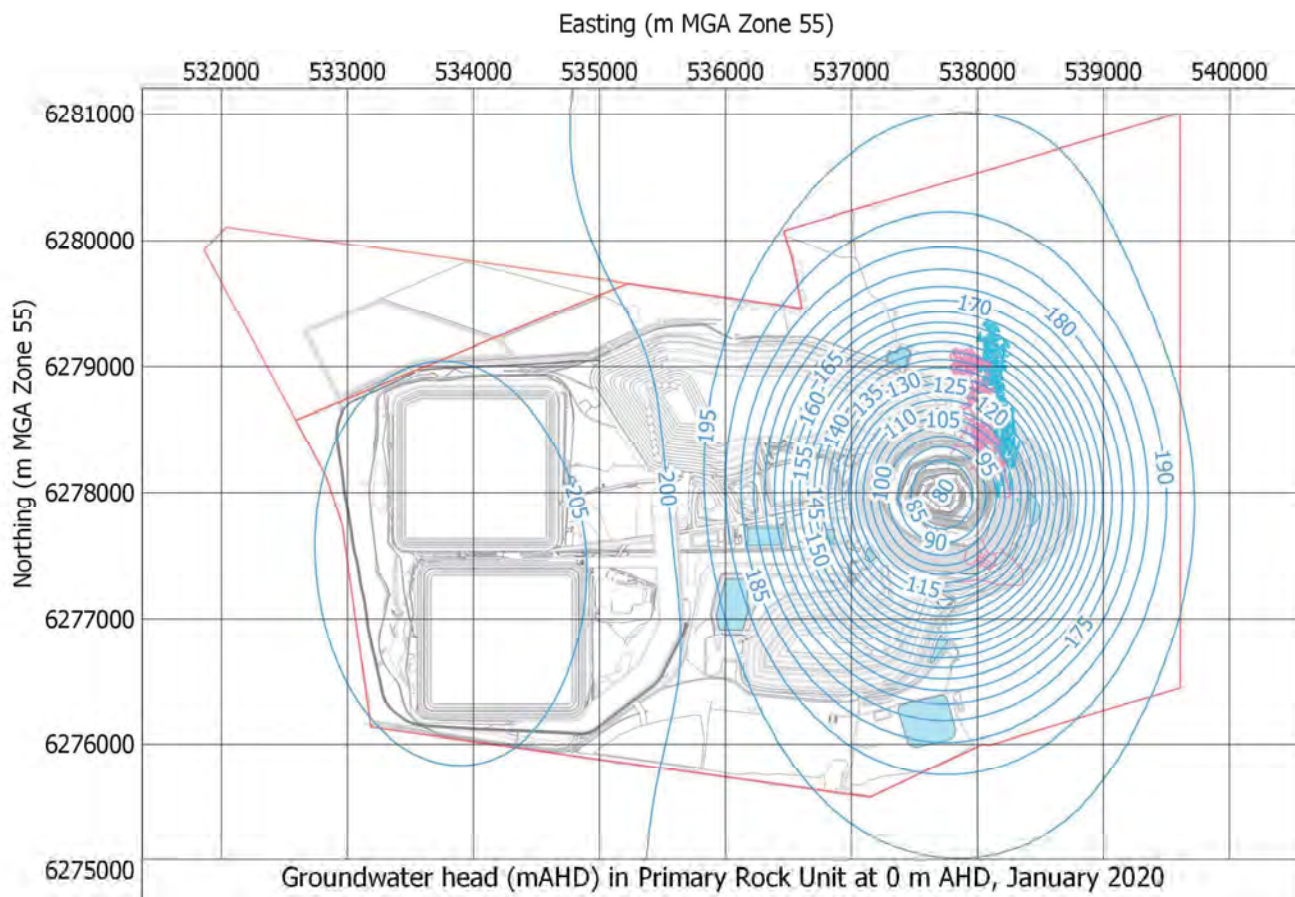

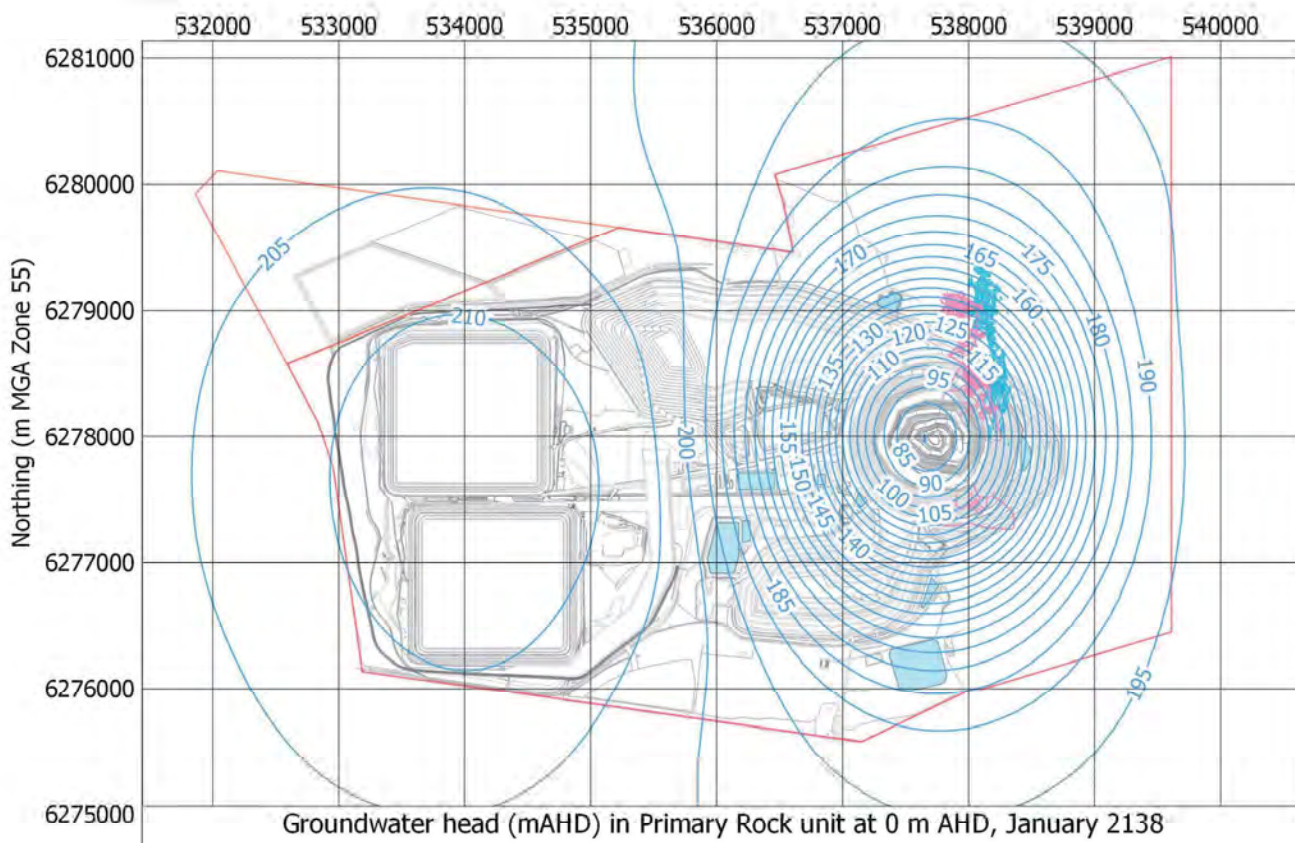
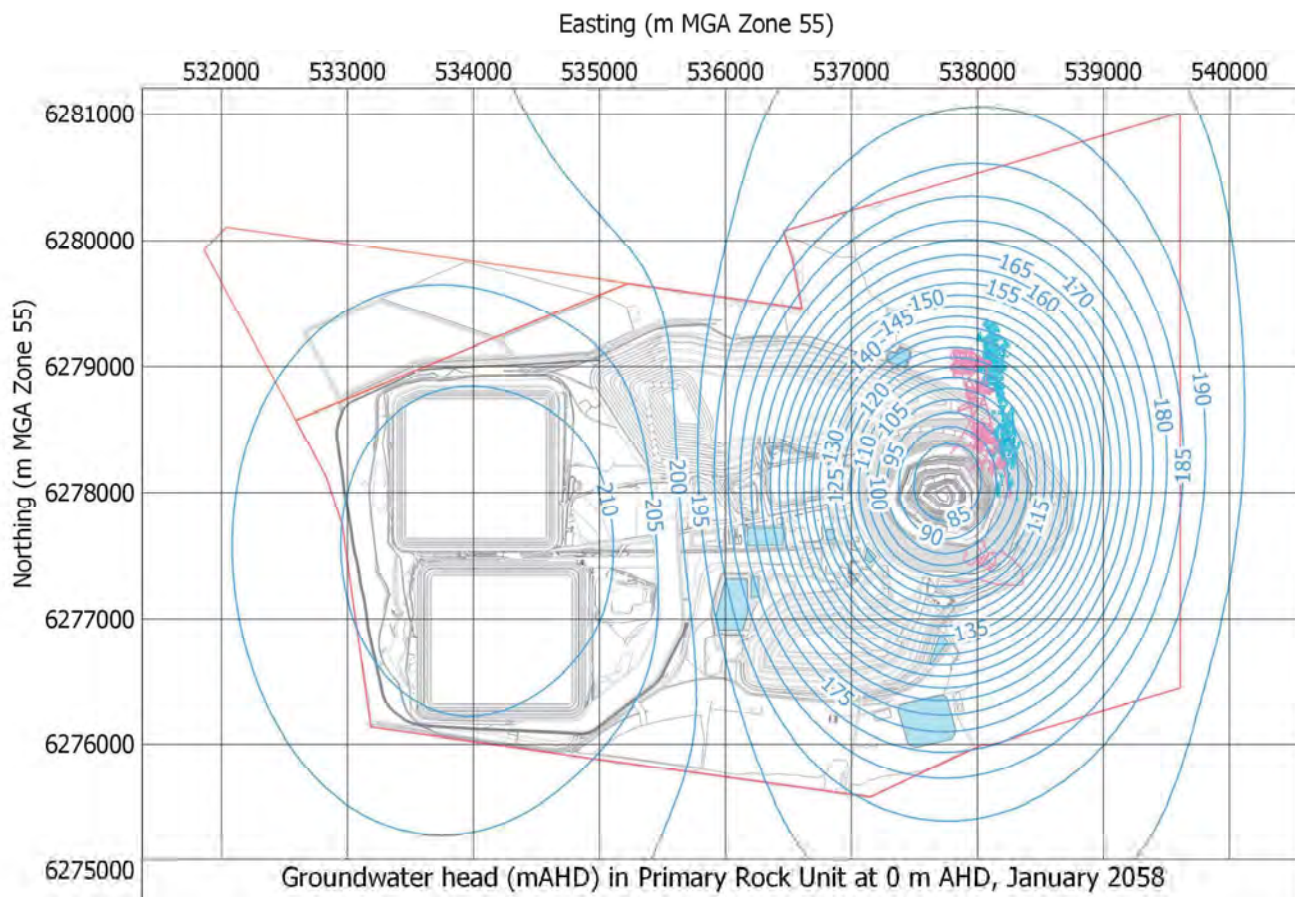

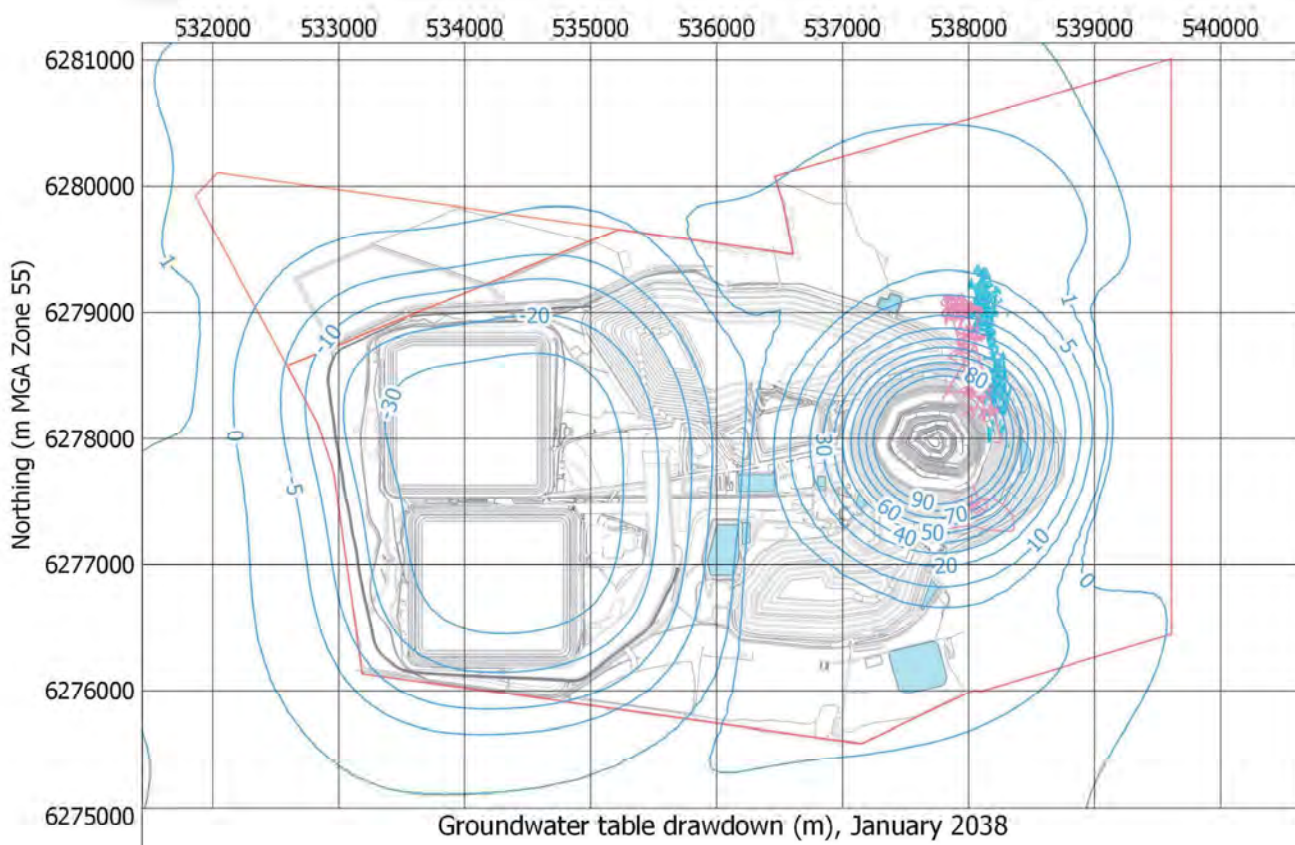
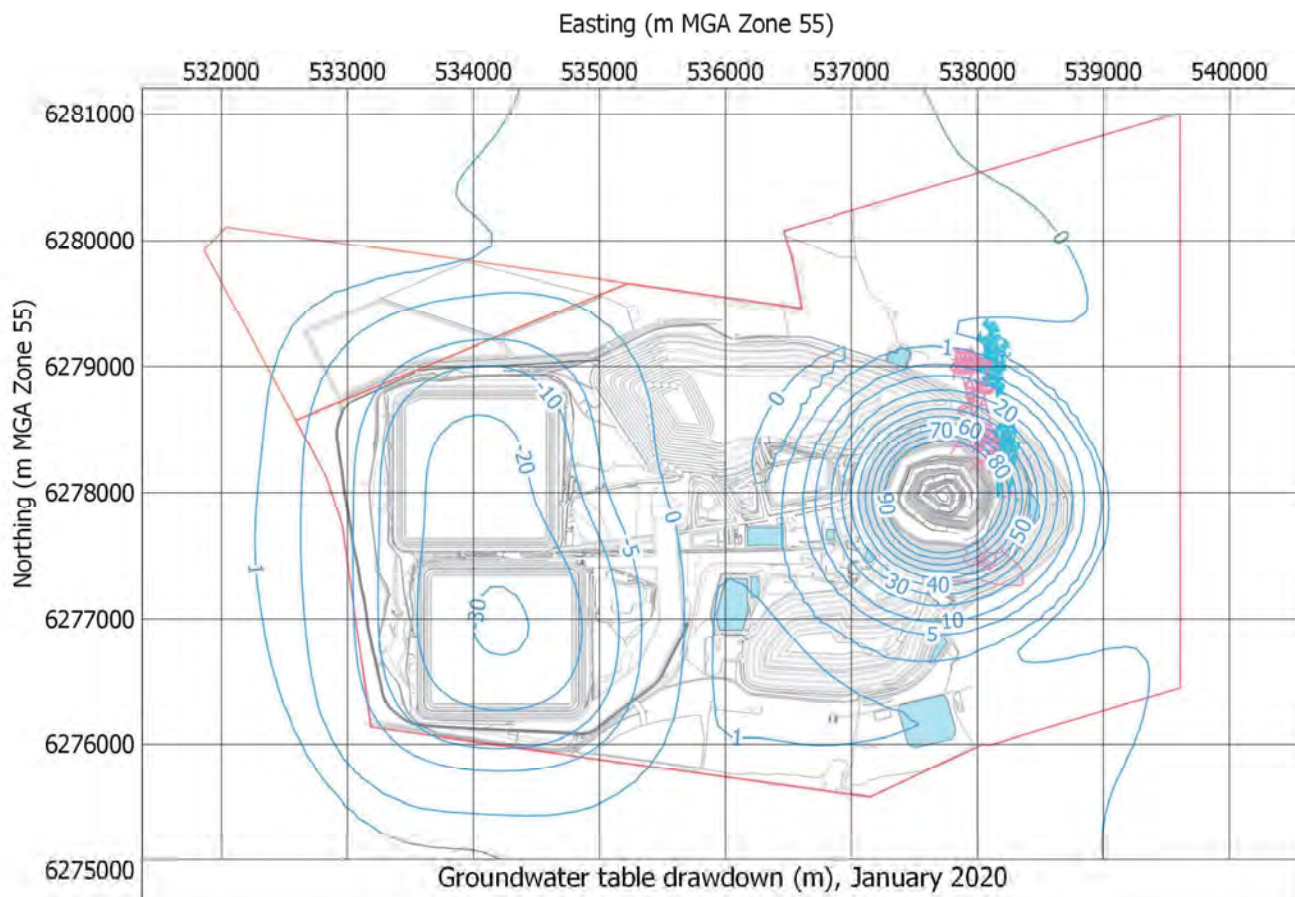

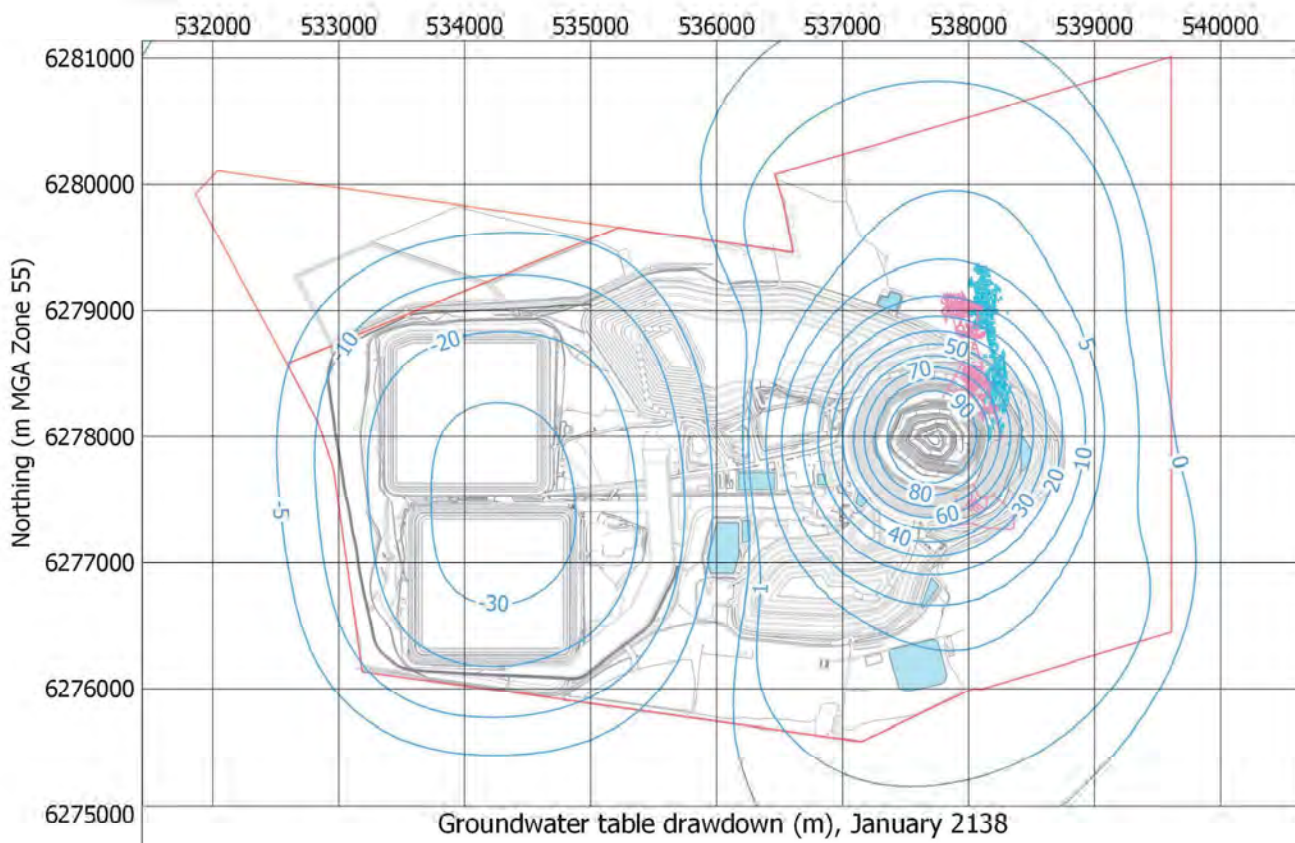
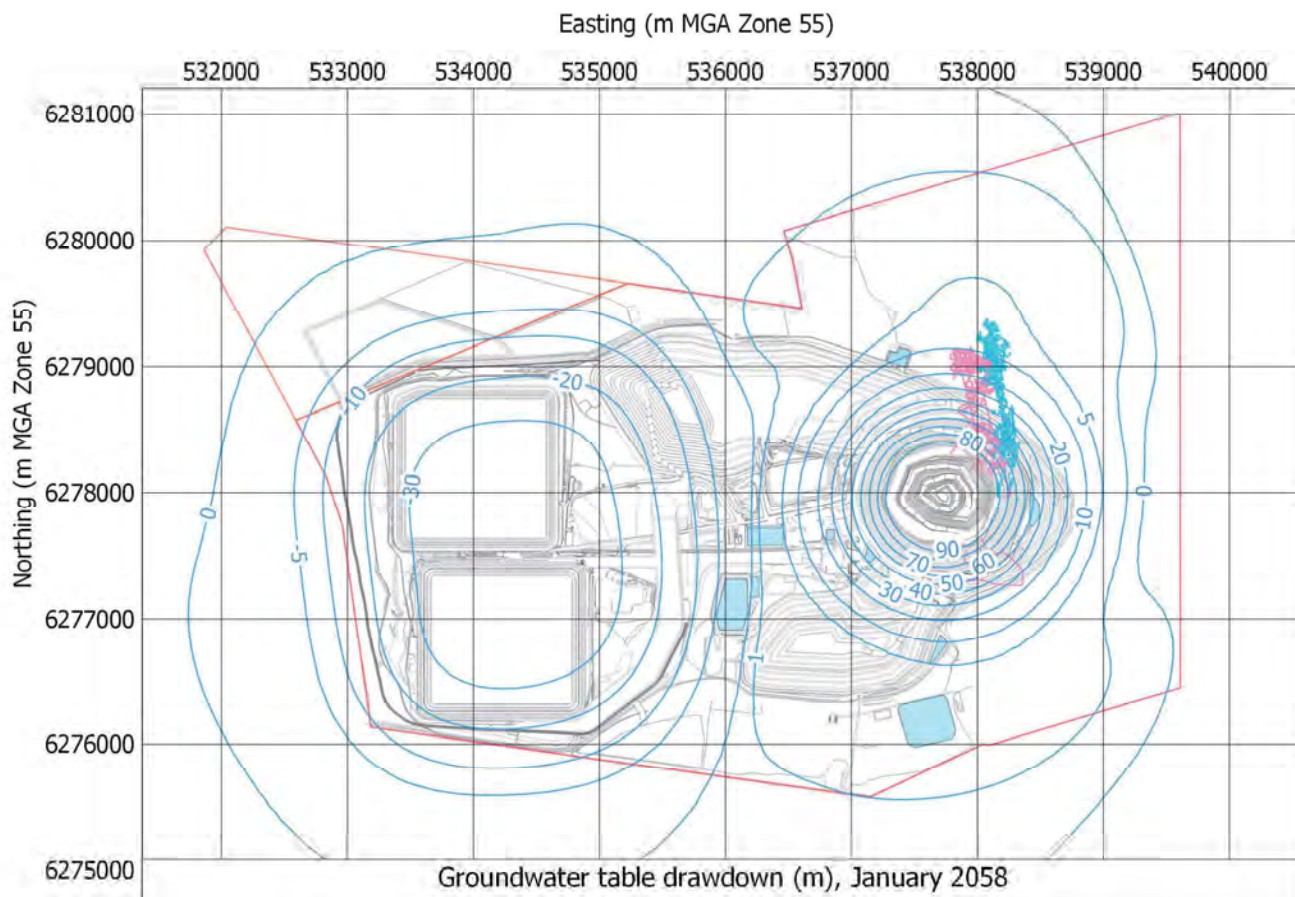

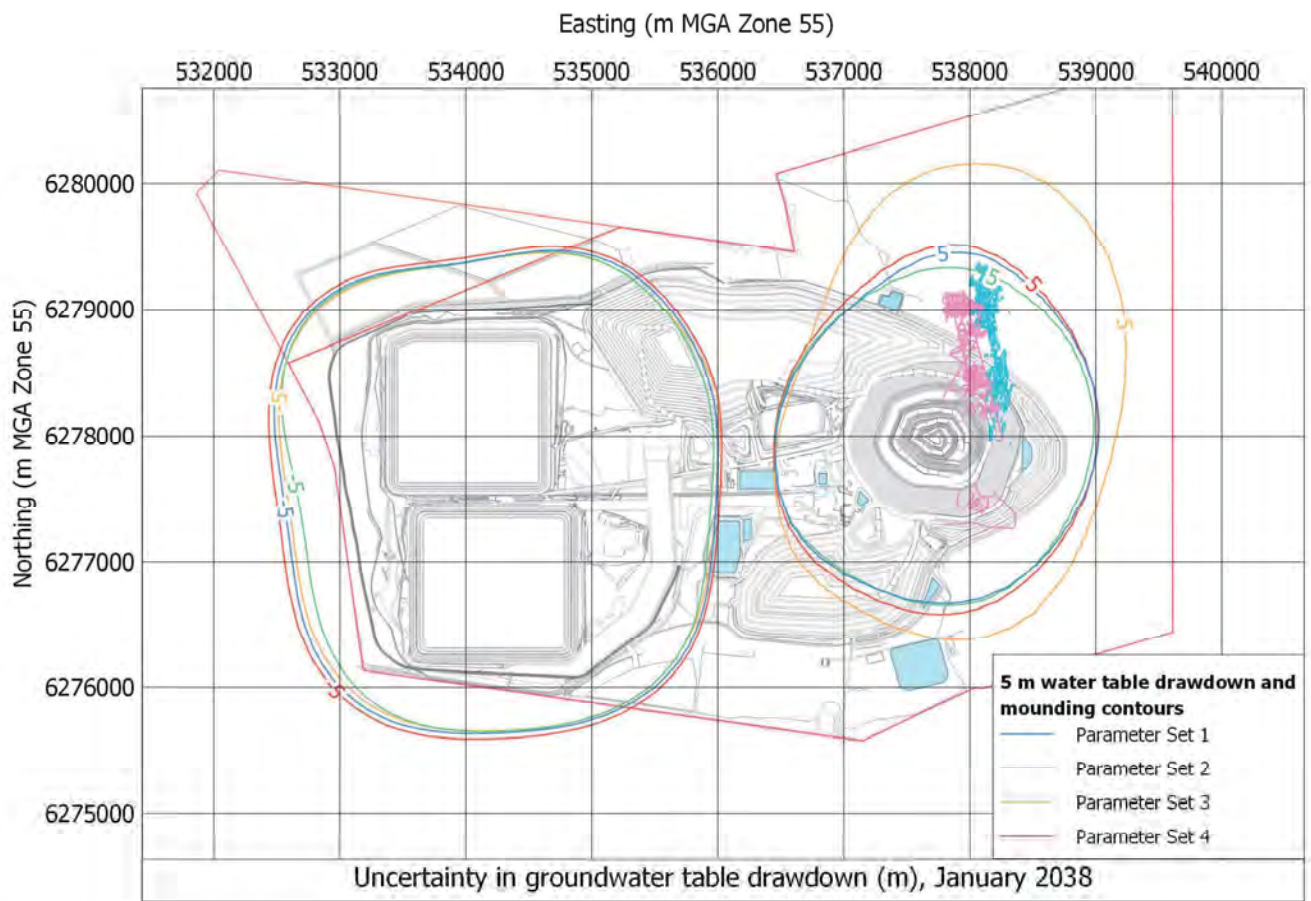

Appendix D - Particle tracking

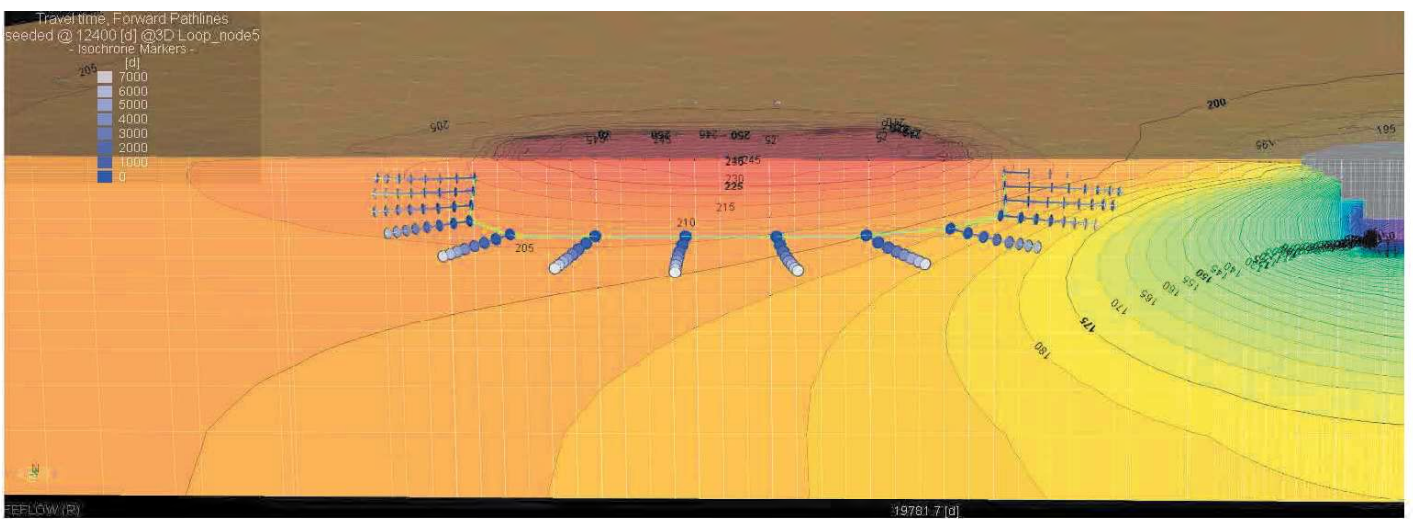
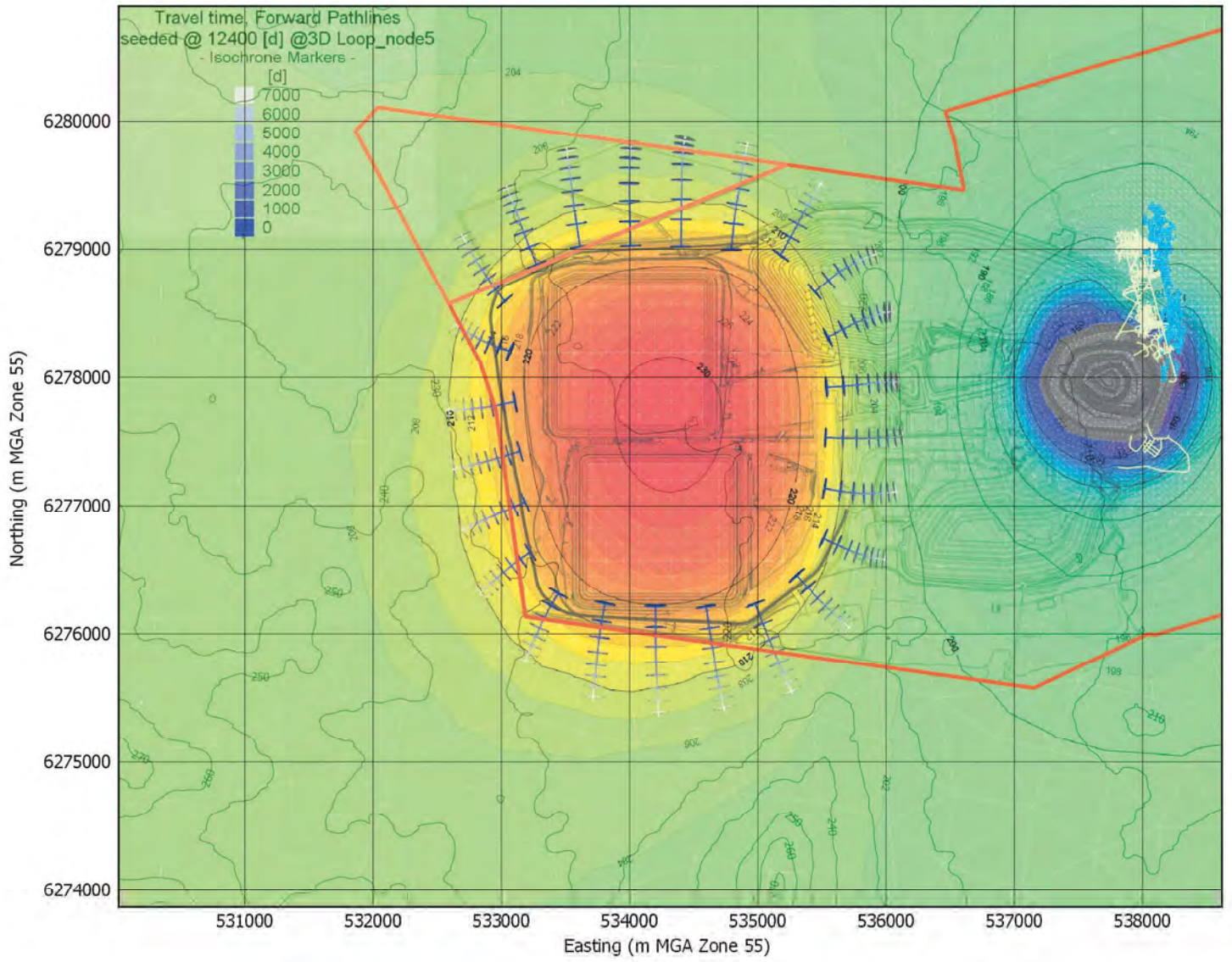

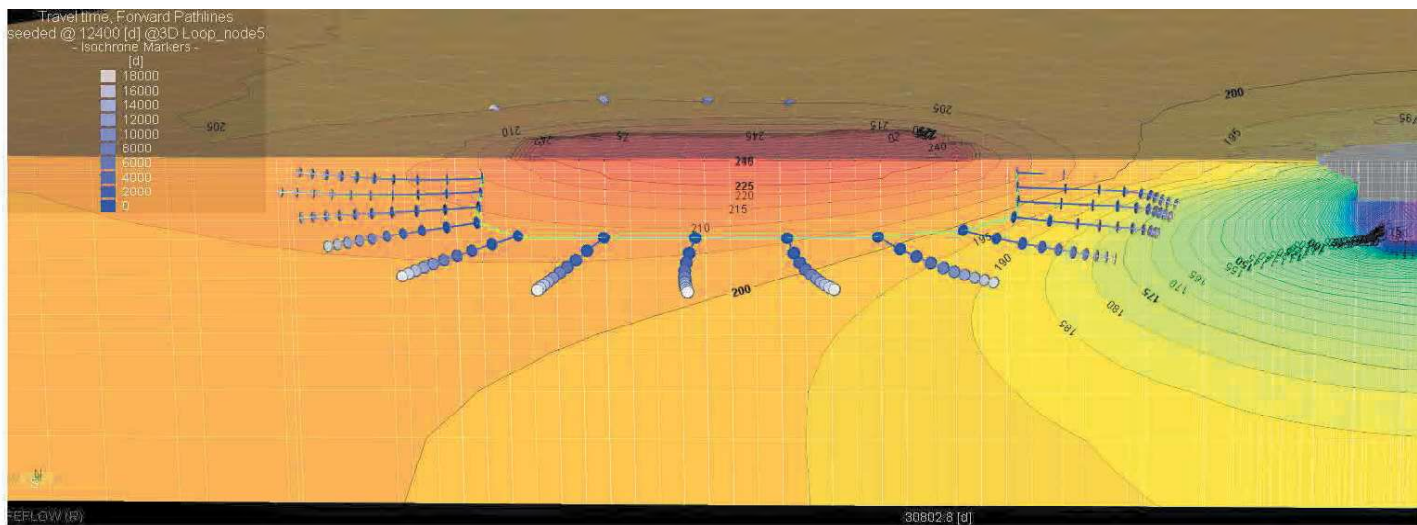
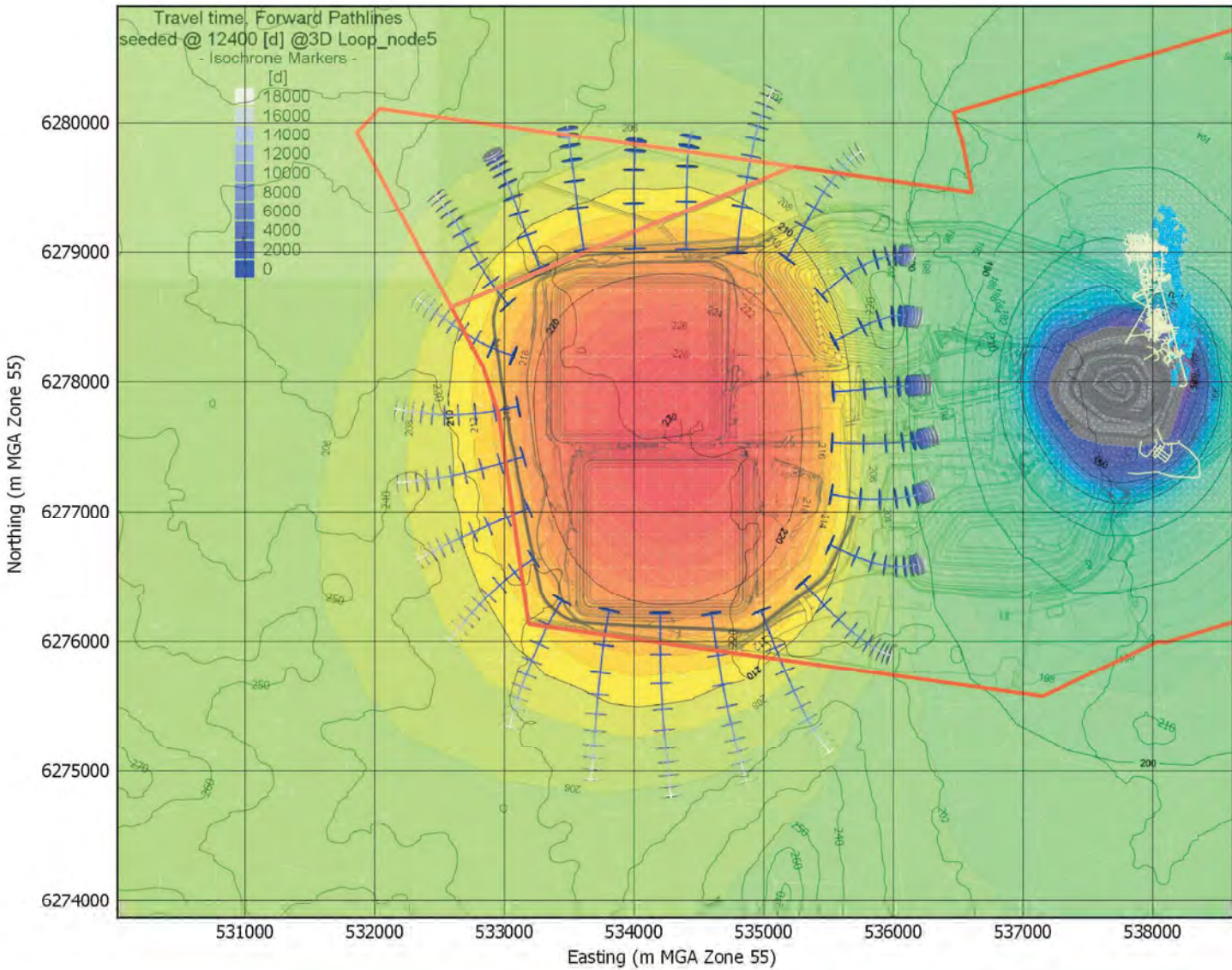

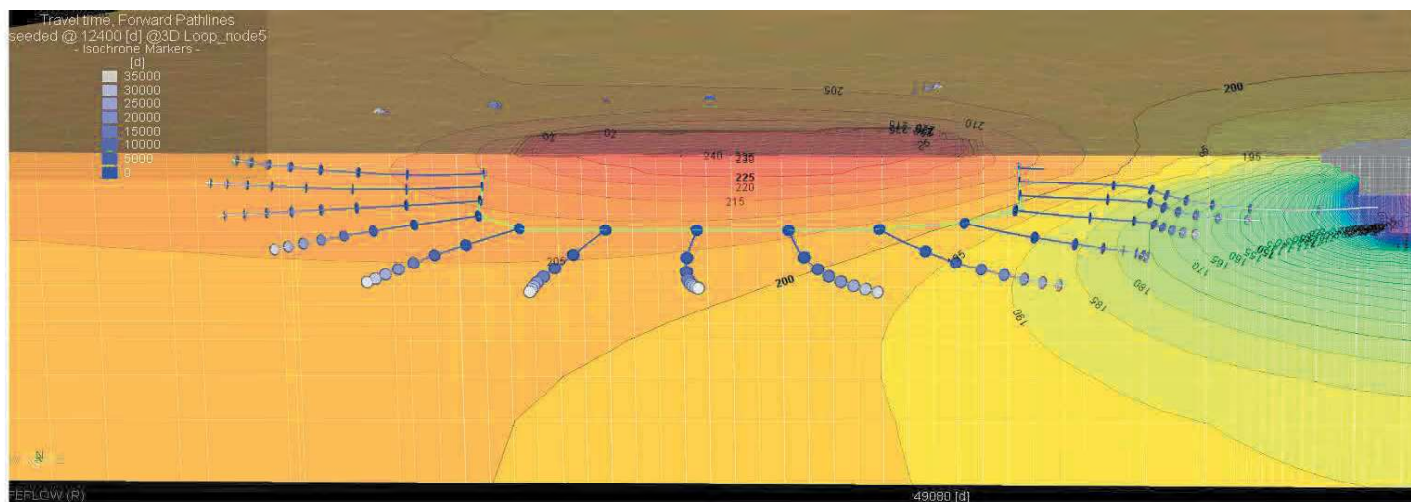
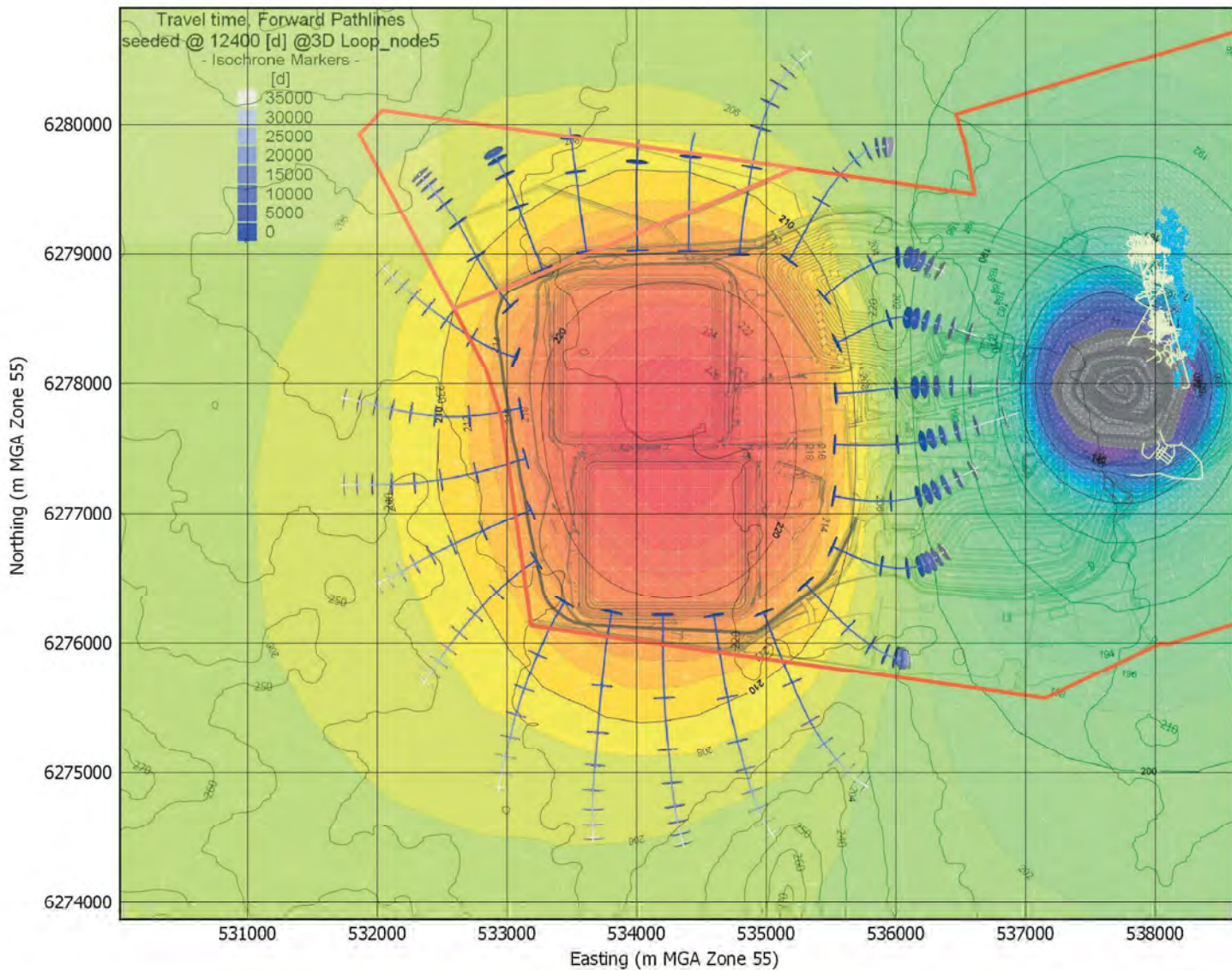

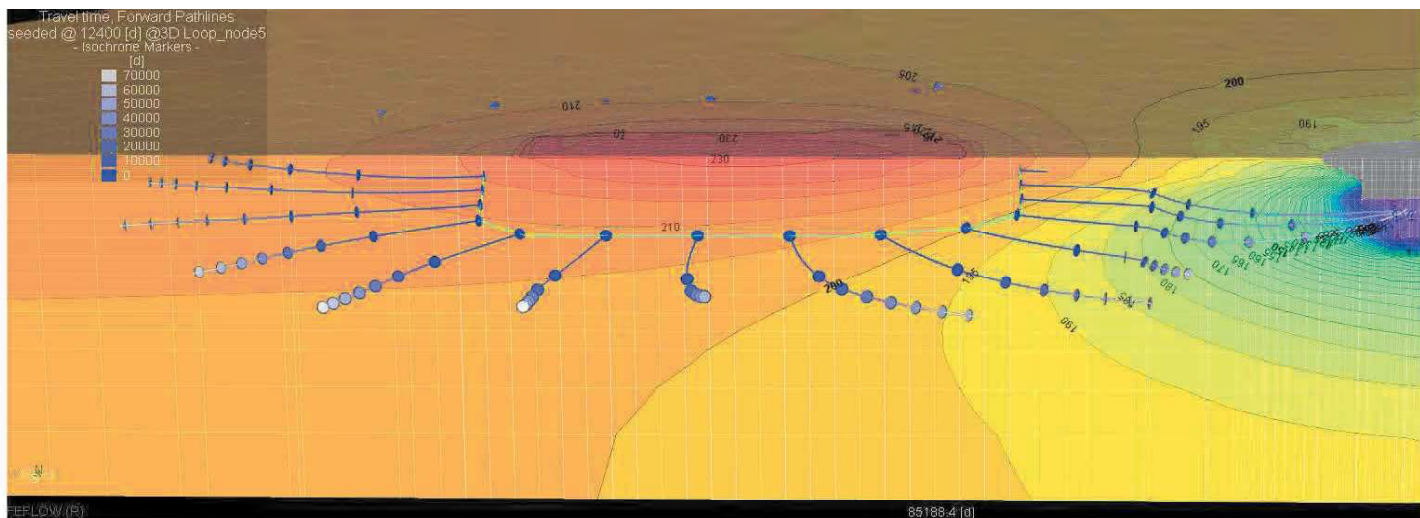
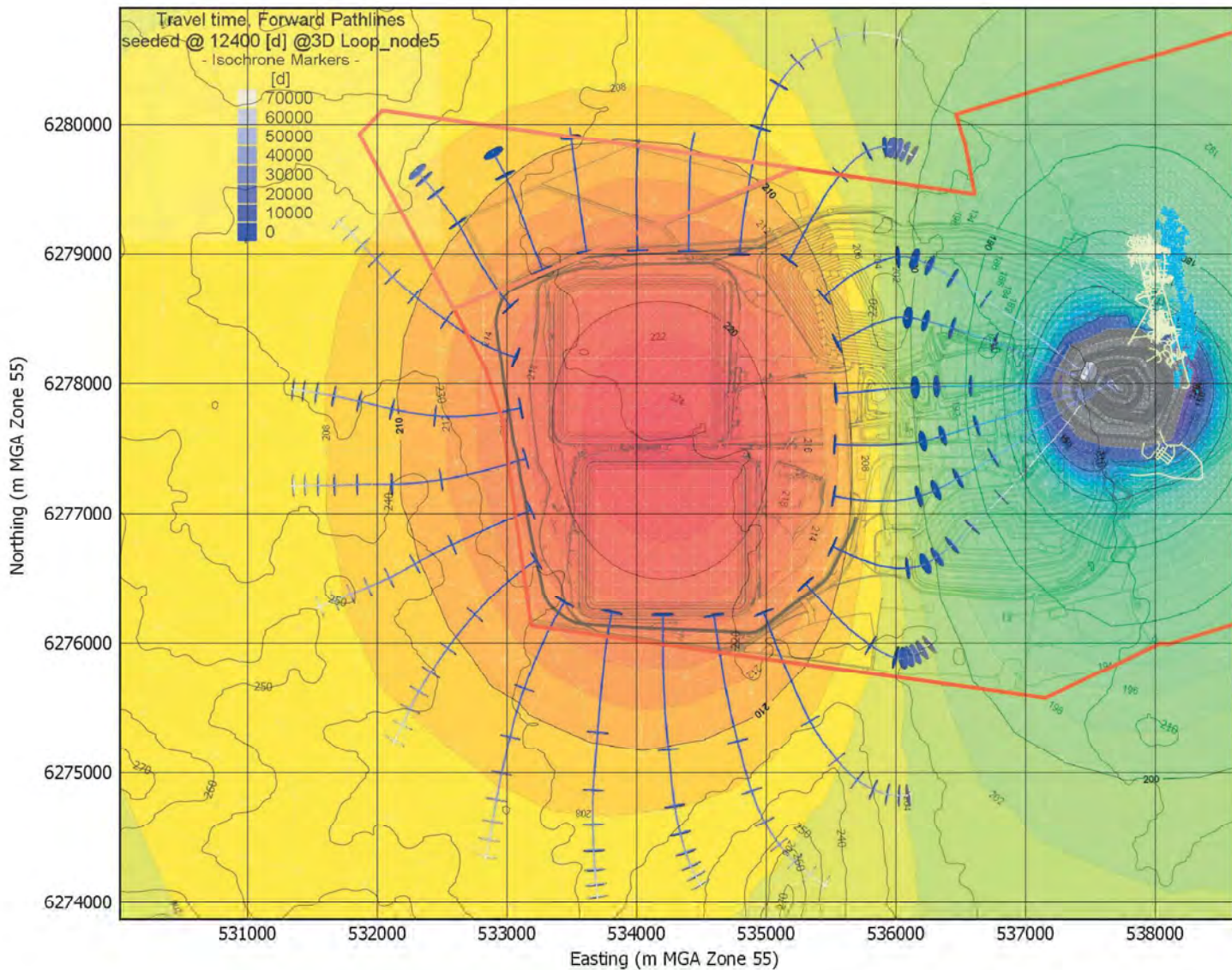

Appendix E - Field investigations report

EMM Consulting Pty Ltd
CGO Underground Development EIS
Groundwater site investigations report

6 April 2020

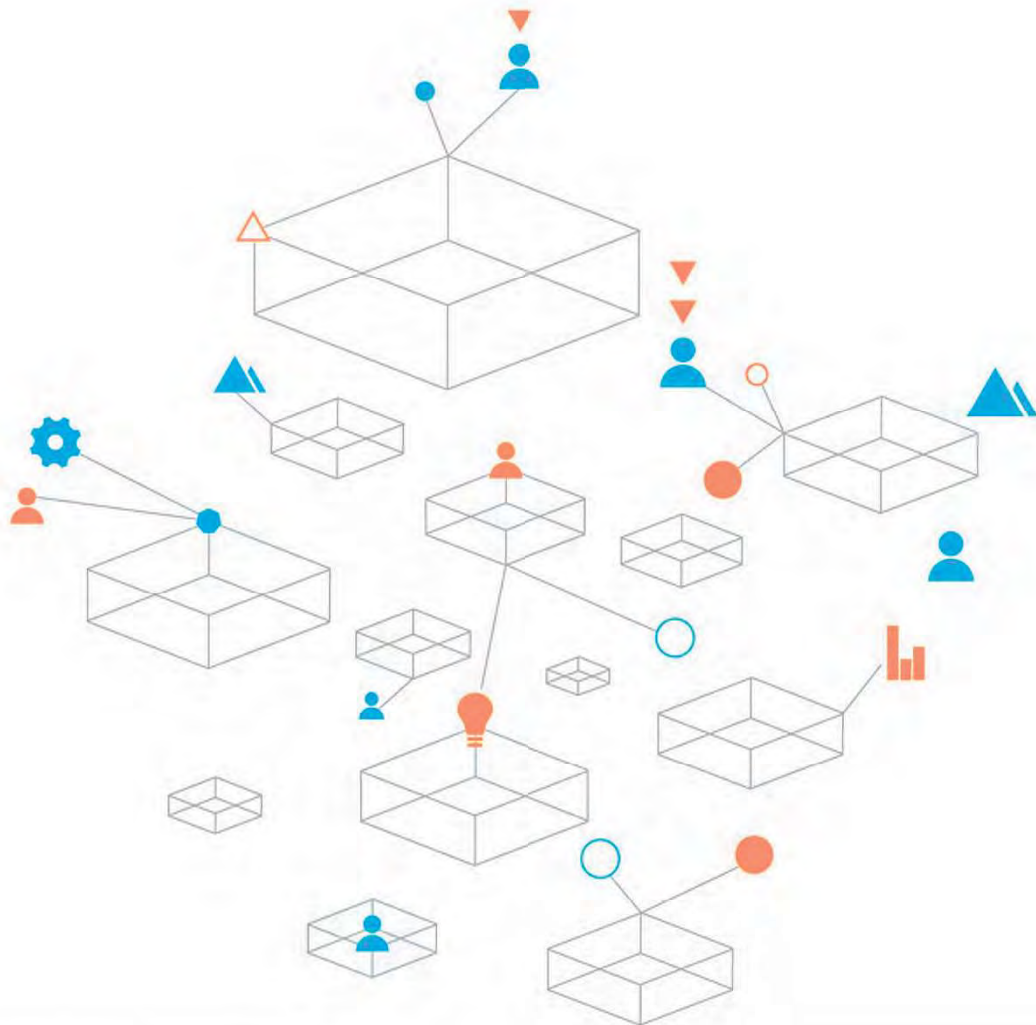

Trust is the
cornerstone
of all our
projects

This page has been left intentionally blank

CGO Underground Development EIS

Prepared for
EMM Consulting Pty Ltd

Prepared by
Coffey Services Australia Pty Ltd
Level 19, Tower B, Citadel Tower, 799 Pacific Highway
Chatswood
NSW 2067 Australia
t: +61 2 9406 1000 f: +61 2 9415 1678
ABN 55 139 460 521

6 April 2020

Groundwater site investigations report

SYDGE206418-3-AJ

Quality information

Revision history

Revision	Description	Date	Originator	Reviewer	Approver
Issued	Issued	27 March 2020	AO	RJB	RJB
Rev 1	Revised following EMM comment	6 April 2020	AO	RJB	RJB

Distribution

Report Status	No. of copies	Format	Distributed to	Date
Issued	1	PDF	Alex Newton	27 March 2020
Rev 1	1	PDF	Alex Newton	6 April 2020

Table of contents

1. Background	1
2. Regional geology	2
3. Hydrogeology	4
3.1. Regional hydrogeology	4
3.2. Mine site hydrogeology	5
4. Fieldwork	6
4.1. Surface borehole drilling	6
4.1.1. Observed geological conditions	8
4.2. Geophysics – Natural gamma logging	8
4.3. Packer testing.....	9
4.4. Installation of piezometers	10
4.4.1. Allowance for flooding of Lake Cowal	10
4.5. Piezometer installation in exploration decline	12
4.6. Mapping of seepage into exploration decline.....	12
5. Discussion of results.....	13
5.1. Aquifer parameters.....	13
5.1.1. Seepage into the exploration decline	13
5.2. Geophysics - Natural gamma logging	14
5.3. Exploration boreholes	15
5.4. Geophysics - gravity survey interpretation	16
5.5. Groundwater levels	18
5.6. Groundwater levels adjacent to the exploration decline	20
6. Summary	22
7. References	24

Tables

Table 1: Land borehole details

Table 2: Ground conditions

Table 3: Packer testing results

Table 4: Piezometer elevations

Table 5: Observed seepage in exploration decline (27 February 2020)

Table 6: Existing piezometers near the proposed underground development

Figures

- Figure 1: Mine site (Aerial imagery provided by Evolution Mining)
- Figure 2: Quaternary and Tertiary geology (Source: Seamless Geology of NSW)
- Figure 3: Devonian and Ordovician geology (Source: Seamless Geology of NSW)
- Figure 4: Conceptual hydrogeological model
- Figure 5: Location plan
- Figure 6: Natural gamma logging setup
- Figure 7: Telemetry installation
- Figure 8: Packer test results
- Figure 9: UG-BH-02 core photo showing Lake Sediments (13.0 m - 18.9 m)
- Figure 10: Depth to the base of Lake Sediments and Saprolite units as interpreted from exploration boreholes
- Figure 11: Elevation of the base of the Lake Sediments from gravity survey interpretation
- Figure 12: Thickness of the Lake Sediments from gravity survey interpretation
- Figure 13: Observed and modelled groundwater head at new piezometers (base of column shows sensor elevation, top of column shows groundwater heads)
- Figure 14: Observed and modelled groundwater head at existing piezometers (base of column shows sensor elevation, top of column shows groundwater heads)
- Figure 15: Groundwater pressures at UG-DHBH-01
- Figure 16: Groundwater pressures at UG-DHBH-02
- Figure 17: Groundwater pressures at UG-DHBH-03

Appendices

- Appendix A – Borehole logs
- Appendix B – Natural gamma logging
- Appendix C – Packer test results
- Appendix D – Seepage into exploration decline
- Appendix E – Piezometer details and groundwater monitoring hydrographs

1. Background

Cowal Gold Operations (CGO) is an existing open cut mine site, which has been operational since commencement in 2005, located adjacent to the ephemeral lake, Lake Cowal. The mine is owned and operated by Evolution Mining (Cowal) Pty Limited (Evolution Mining). Evolution Mining seeks to extend mining operations at the CGO by way of an underground development, which would be wholly contained within Mining Lease (ML) 1535. The Underground Development proposal seeks to introduce an underground mine using stope mining practices, in addition to the existing open cut mine, to exploit an identified ore deposit.

The CGO Underground Development includes the development of an underground mining operation beneath Lake Cowal via underground stope mining methods (this would be non-subsiding and no surface expressions of subsidence are anticipated). An exploration decline, GRE46, was constructed by Evolution Mining to explore conditions adjacent to the proposed underground operation. Figure 1 shows the proposed location of the underground operation and exploration decline GRE46 in relation to the existing open cut mine.

A hydrogeological assessment was undertaken by Coffey Services Australia Pty Ltd (Coffey) to assess potential impacts on the groundwater system under the proposed Cowal Gold Operations (CGO) Underground Development (Coffey Report No. SYDGE206418-3-AD, dated 3 February 2020 (Draft)). The assessment employed predictive numerical modelling based on an existing numerical groundwater flow model, taking into account the proposed underground mining to the north of the existing open pit.

To provide evidence in support of groundwater level and hydraulic conductivity assumptions adopted for the hydrogeological assessment, a field investigation program was carried out between 28 January and 29 February 2020. This report presents the results of the field investigations.

The results provide information on:

- Thickness and composition of the lake bed sediments near the proposed CGO Underground Development.
- Groundwater levels to the north of the existing open pit within Lake Cowal.
- Hydraulic properties of the bedrock.
- An assessment of groundwater levels near the exploration decline.
- An assessment of the change in permeability (and extent of the zone of altered permeability) due to stress changes in the rock caused by the tunnelling.

Figure 1 shows the mine site including the proposed CGO Underground Development and the exploration decline to the north east of the open pit.

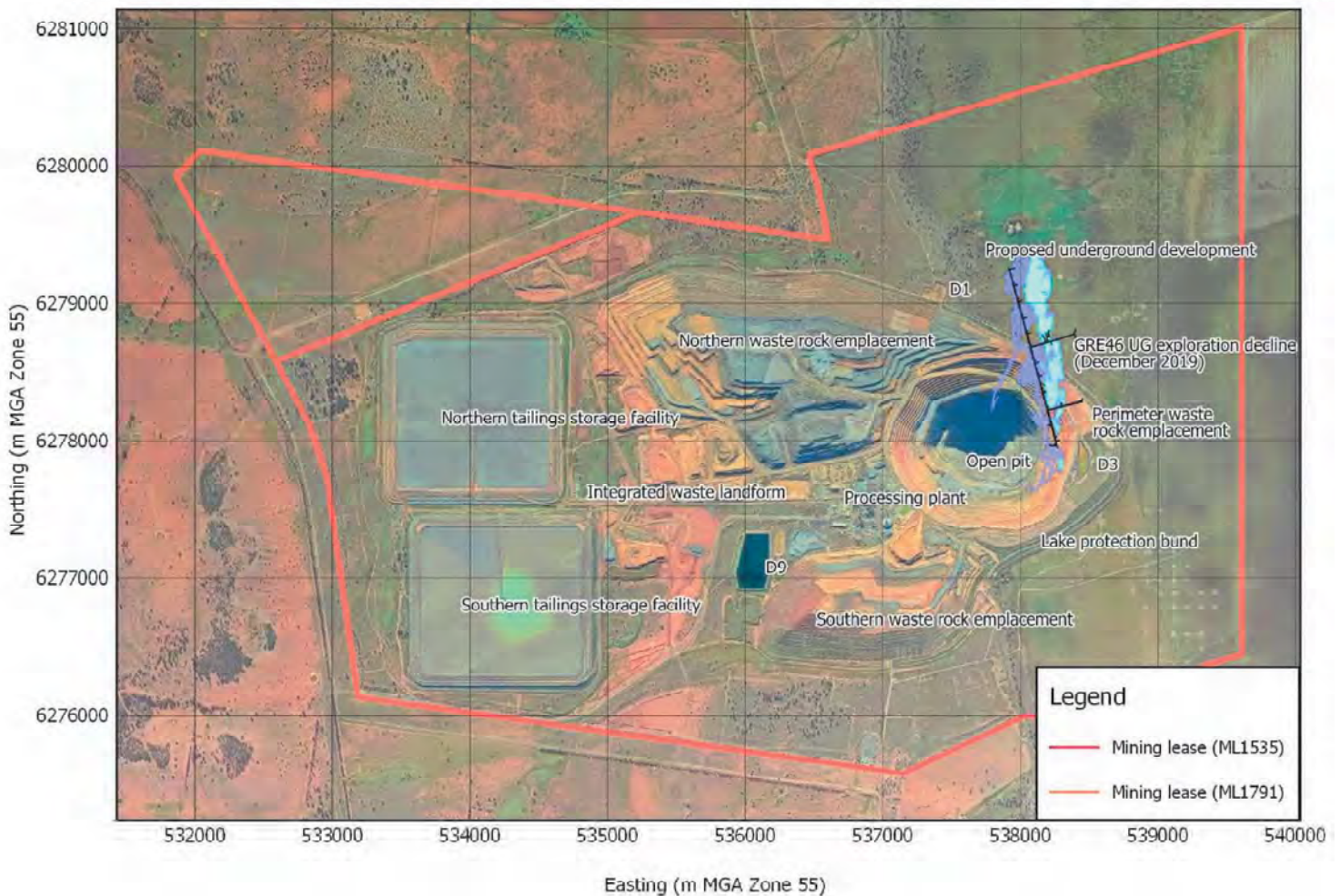

Figure 1: Mine site (Aerial imagery provided by Evolution Mining)

2. Regional geology

The Forbes 1:250,000 Geological Map shows that the regional geological setting is dominated by the Gilmore Fault Zone also called the Gilmore Suture, a structurally and lithologically complex feature that trends north-south through ML1535, approximately 500 m west of the CGO open pit.

The fault separates a Late Ordovician volcanoclastic sequence (referred to as the Lake Cowal Volcanic Complex) from the Siluro Devonian sedimentary basement to the west. Siluro Devonian sedimentary rocks also occur east of the Lake Cowal Volcanic Complex on the eastern side of Lake Cowal, where the basement has been deeply incised and hosts palaeochannel deposits of the Bland Creek unit.

The region is covered by varying thicknesses of Tertiary and Quaternary regolith deposits. The Bland Creek Palaeochannel Plain was formed by the infilling of the Lachlan and Bland Creek Palaeochannels, located to the north and east of Lake Cowal, respectively, with sediments of the Lachlan and Cowra Formations. The depth of these sediments is over 100 m. Locally, Pleistocene Cowra alluvium overlies ML1535 and thick Quaternary lacustrine sediments underlie Lake Cowal.

The geology of the CGO site and surrounds is illustrated in Figure 2 and Figure 3.

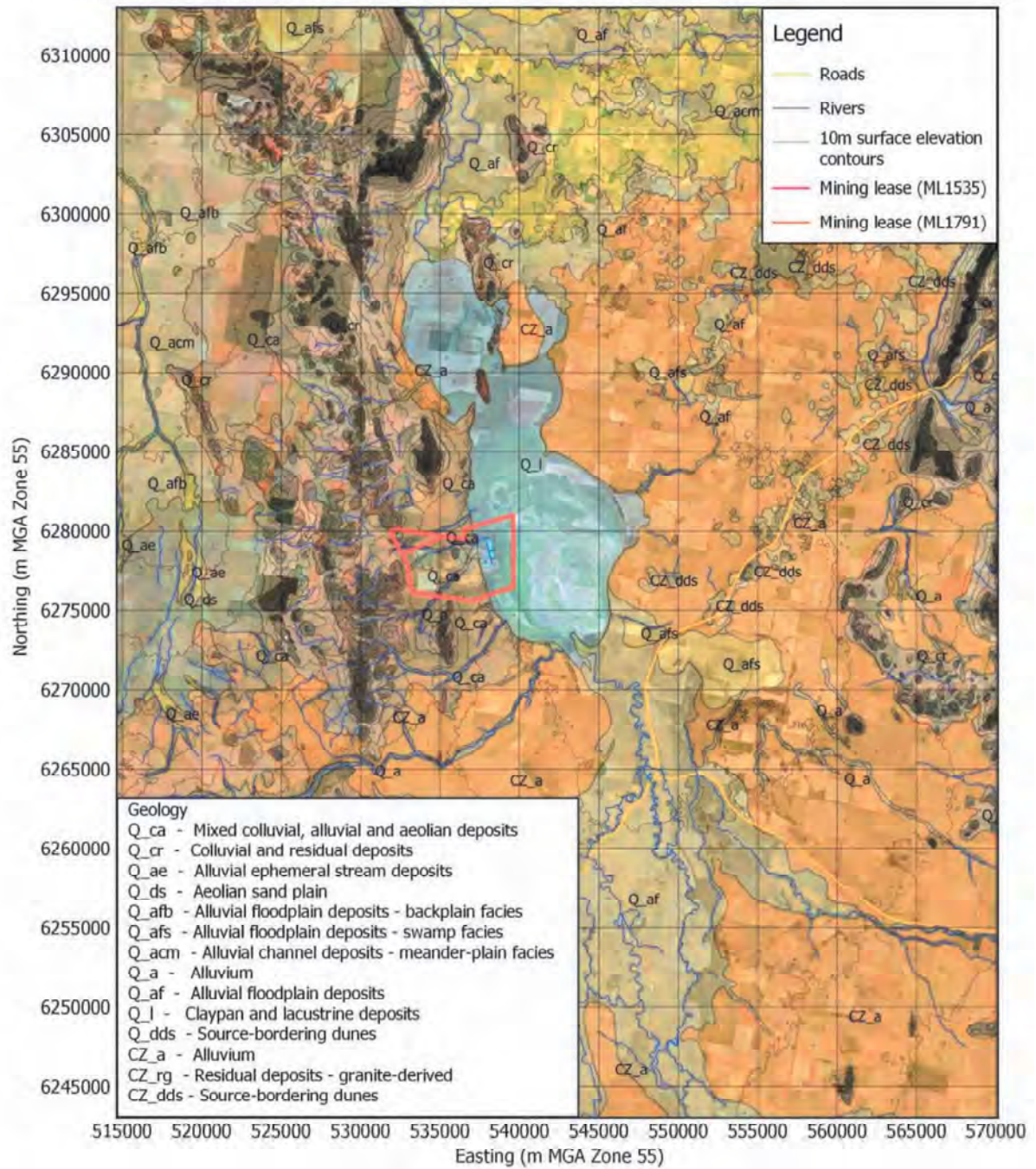

Figure 2: Quaternary and Tertiary geology (Source: Seamless Geology of NSW)

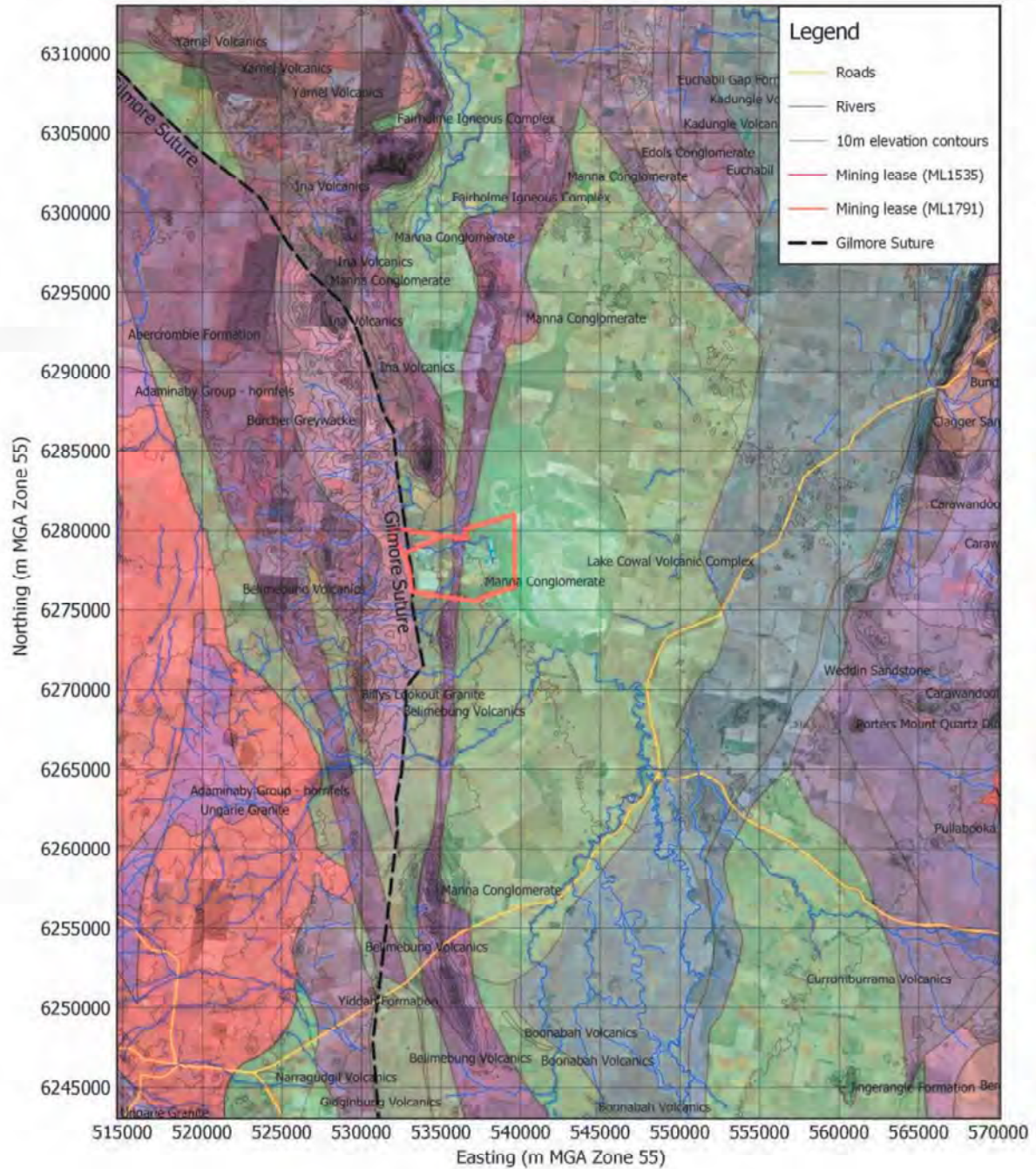

Figure 3: Devonian and Ordovician geology (Source: Seamless Geology of NSW)

3. Hydrogeology

3.1. Regional hydrogeology

Regionally, groundwater resources are present in the Bland Creek Palaeochannel, and include the following two geological formations:

- Cowra Formation: comprises isolated sand and gravel lenses in predominantly silt and clay alluvial deposits, with groundwater of generally higher salinity; and

- Lachlan Formation: comprises quartz gravel with groundwater of generally low salinity.

Three distinct alluvial sequences were interpreted to be present, based on the distribution of hydraulic conductivity with depth assessed by Coffey (2006). These are as follows:

- Upper Cowra Formation: this sequence generally occurs from ground surface to a depth of up to approximately 50 m. It is present over most of the CGO site and surrounding area. The average depth to groundwater is approximately 7 m, giving an average saturated thickness of just over 40 m (Coffey, 2006). The data suggest the Upper Cowra sequence generally shows decreasing hydraulic conductivity with depth and greater stratification than that found in deeper layers.
- Lower Cowra Formation: this sequence generally occurs over an average depth interval of approximately 50 m to 90 m over most of the CGO site and surrounding area. This layer appears to have lower horizontal hydraulic conductivity values than the Upper Cowra Formation.
- Lachlan Formation: this sequence generally occurs over an average depth interval of around 90 m to 120 m in the Bland Creek Palaeochannel. Within this formation there were assessed to be two distinct sequences, including:
 - High permeability sands and minor gravels close to, and within, the deeper parts of the palaeochannel.
 - Lower permeability sediments that generally occur further away from the deeper parts of the palaeochannel and surround the high permeability sands and minor gravels. The average hydraulic conductivity of this sequence appears similar to the Lower Cowra Formation.

Coffey (2006) interpreted that the western limit of the Cowra Formation extends within the eastern boundary of ML1535, but that the Lachlan Formation did not extend into ML1535. Pre-mining groundwater flow within ML1535 was generally from east to west under a hydraulic gradient of approximately 0.1%, increasing to 0.3% further west.

Geological data available from the Bland Creek Palaeochannel Borefield to the north-east of the CGO site and from the Bland Creek system to the south-east of the CGO site have also been used in characterising the regional hydrogeology.

3.2. Mine site hydrogeology

Locally, at the CGO site, four hydrogeological units have been identified:

- The Lake Sediments or Transported unit: Comprises alluvium (thick clay sequences and more permeable zones of gravel within a sandy clay matrix) of the Quaternary-aged Cowra Formation. The Cowra Formation is laterally equivalent to the Transported unit (Barrick Australia Limited, 2010).
- The Saprolite unit: Underlies the Transported unit and is of relatively low hydraulic conductivity. The unit comprises extremely weathered rock, often weathered to clay.
- The Saprock unit: Underlies the Saprolite unit and occurs in the weathered fractured surface of the Lake Cowal Volcanics. The unit comprises highly to moderately weathered rock with some zones of clay.
- The Primary Rock unit: Consists of the slightly weathered to fresh rock underlying the Saprock unit. This unit is generally considered to be less fractured and less permeable than the Saprock.

Note that the boundaries between the weathered rock units are gradational and weathering profiles may extend over 50 m or more.

Figure 4 presents a conceptual hydrogeological model of the mine site.

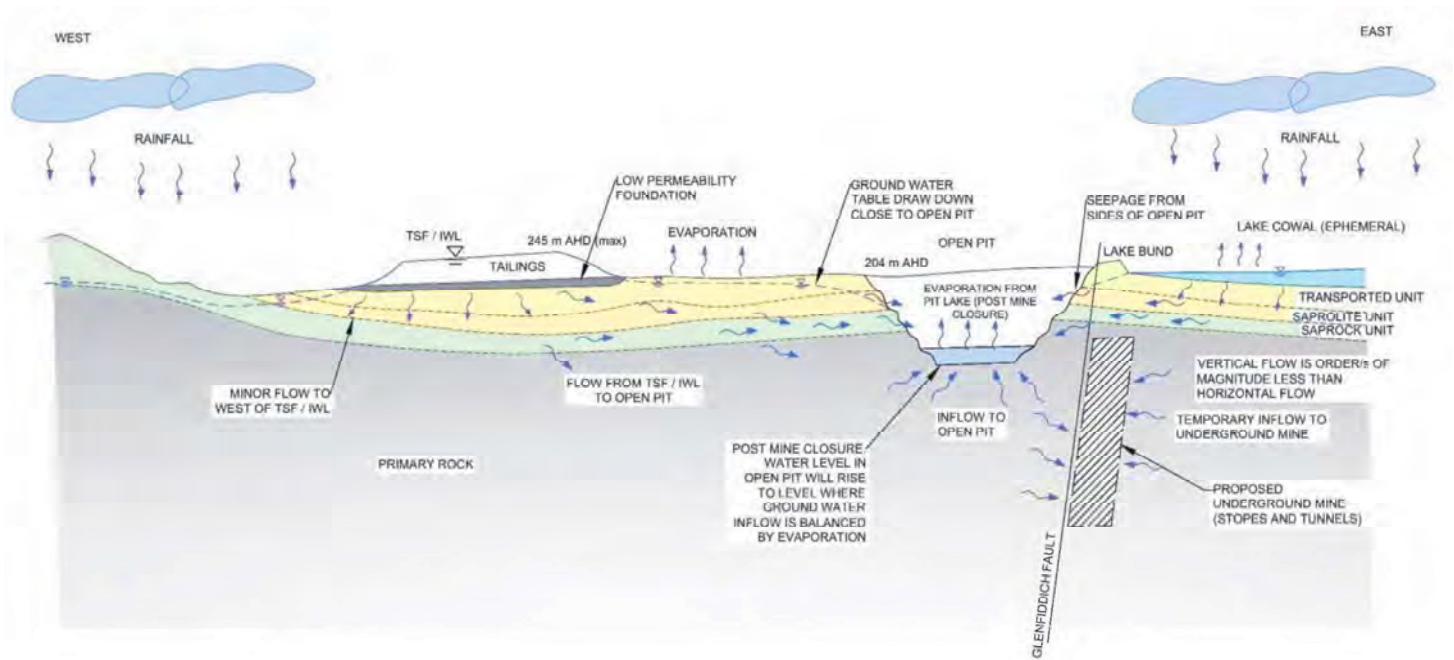

Figure 4: Conceptual hydrogeological model

4. Fieldwork

To provide evidence in support of groundwater level and hydraulic conductivity assumptions adopted for the CGO Underground Development EIS, a field investigation program was carried out between 28 January and 29 February 2020. Coffey field engineers attended the CGO mine site from 28 January 2020 to 29 February 2020 to supervise drilling and testing and to complete the piezometer installations associated with the field investigations.

Four vertical boreholes (UG-BH-01, UG-BH-02, UG-BH-03 and UG-BH-04) were drilled on the surface of Lake Cowal. Lake Cowal was dry during the fieldwork and at the time of writing this report (March 2020). Two boreholes were drilled to 70 m and two boreholes were drilled to 100 m depth. Coffey field engineers performed geophysical natural gamma logging. Borehole water pressure (packer) testing was carried out by the drillers at locations nominated by Coffey on selected boreholes. After testing was completed, three strain gauge piezometers were installed in each borehole at varying depths and the boreholes were then backfilled with a bentonite grout mix.

12 sub-horizontal boreholes were drilled in the GRE46 underground exploration decline at three locations, with four boreholes of lengths of 2 m, 4 m, 6 m and 10 m at each location. A strain gauge piezometer was installed at the base of each of these boreholes and the boreholes were then backfilled with a bentonite grout mix. The piezometers were activated one week after grouting and the monitoring data was collected three weeks later.

To provide additional information on the hydraulic conductivity of the bedrock, a Coffey field engineer conducted site observations of the underground decline, mapping observable water inflows and providing an estimate of inflow rates where practicable.

Figure 5 shows the location of the new boreholes, the exploration decline and the location of nearby existing monitoring wells.

4.1. Surface borehole drilling

Borehole drilling was conducted by the DDH Drilling company. Drilling was advanced using tungsten carbide bit augers to approximately 5.5m depth, followed by HQ coring to final depth. Table 1

provides the details of the surface (land) boreholes. Horizontal coordinates were surveyed using RTK GPS. Elevations were derived from a topographic survey provided by Evolution Mining.

Table 1: Land borehole details

Borehole	Easting (m MGA zone 55)	Northing (m MGA zone 55)	Elevation (m AHD)	Inclination	End of hole depth (m)
UG-BH-01	537751.6	6278843.8	204.1	Vertical	72.0
UG-BH-02	538180.0	6279593.8	203.8	Vertical	102.8
UG-BH-03	538019.1	6278883.0	203.9	Vertical	72.0
UG-BH-04	538169.0	6278916.0	203.8	Vertical	102.0

Borehole logs and core photos are provided in Appendix A. Note that the core boxes for UG-BH-04 were labelled as UG-BH-05 on site by the drillers.

The borehole logs provided in Appendix A are included for information only are not intended for use in engineering design. For this reason, the borehole logs are marked as DRAFT.

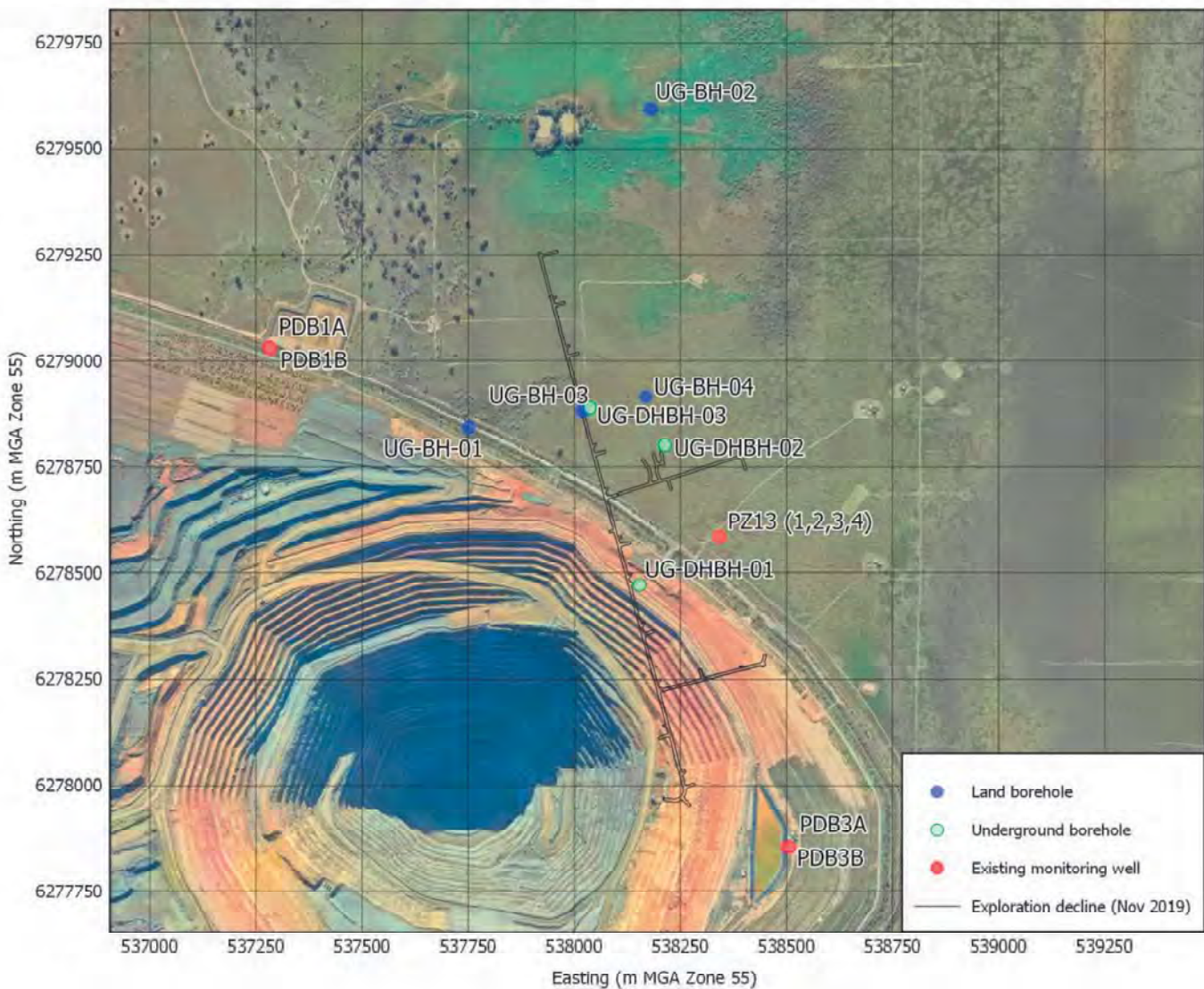

Figure 5: Location plan

4.1.1. Observed geological conditions

The following materials were encountered during borehole drilling:

- Lake Sediments: Comprising clays to sandy clays with minor sand layers, overlying;
- Residual soil (Saprolite): Comprising silty to sandy clays, overlying;
- Highly to moderately weathered bedrock (Saprock): Comprising mudstones or andesite, overlying;
- Slightly weathered to fresh bedrock (Primary Rock): Comprising mudstones or andesite.

Table 2 summarises the ground conditions encountered in the boreholes.

Table 2: Ground conditions

Borehole ID	Lake Sediments	Saprolite	Saprock	Primary Rock
UG-BH-01	0 – 18.9 m	18.9 – 37.1 m	37.1 – 72.0 m	Not observed
UG-BH-02	0 – 20.5 m	20.5 – 45.1 m	45.1 – 102.8 m	Not observed
UG-BH-03	0 – 17.3 m	17.3 – 19.0 m	19.0 – 72.0 m	Not observed
UG-BH-04	0 – 10.6 m	10.6 – 15.7 m	15.7 – 66.7 m	66.7 – 102.2 m

4.2. Geophysics – Natural gamma logging

Natural gamma logging was carried out at boreholes UG-BH-01, UG-BH-02 and UG-BH-04. The location of these boreholes is shown in Figure 5.

Natural gamma logging is a non-destructive, borehole logging methodology that characterises the subsurface material based upon its radioactive signature. In a lithology, the decay products of thorium, uranium and potassium emit gamma rays (Belknap et al., 1959) and natural gamma logging takes advantage of these naturally occurring circumstances by measuring gamma emission intensity at different depth levels. Radioactive elements that emit gamma radiation (K, U, Th) tend to be associated with clay and shale materials and not sand materials, therefore the natural gamma method can be used to estimate layers of higher sand content where decreases in gamma emission are detected.

Figure 6 shows the typical field setup used which comprised a Mount Sopris manufactured Gamma Ray sonde (1.28m), winch, wireline cable, tripod, and top-side 'Matrix' logger system with a laptop computer to control all components.



Figure 6: Natural gamma logging setup

Natural gamma logging was conducted to a depth of 50 m in UG-BH-01, UG-BH-02 and UG-BH-04. Due to technical issues with the natural gamma logging equipment during night drilling, UG-BH-03 was not tested.

The results of the natural gamma logging are provided in Appendix B and discussed in Section 5.2.

4.3. Packer testing

Following completion of borehole drilling, borehole water pressure testing (packer testing) was conducted to provide information about the hydraulic conductivity of the bedrock. Packer testing involved the insertion into the borehole of a straddle packer (two inflatable balloons or 'packers') which isolated a section of rock, typically 5 m in length. Water was pumped into this section of rock, pressure was applied and held constant for a given time. The rate of water flow from the borehole into the surrounding rock was then monitored using a flow meter.

Each packer test involved five test stages, each at a specified test pressure. The test results were interpreted using the method shown by Burgess (1983). Packer tests results are usually reported in Lugeon values, with one Lugeon being defined as a water loss of 1 L per minute, per metre of rock at 1000 kPa driving pressure. One Lugeon is approximately equivalent to a hydraulic conductivity of 1×10^{-7} m/s

A summary of the packer test results is shown in Table 3. Packer tests were not conducted at UG-BH-01 as a suitable section of non-fractured core to seat the packers was not identified.

The packer test results are provided in Appendix C and discussed in Section 5.1.

Table 3: Packer testing results

Borehole	Depth (m)	Unit	Lugeon value	Hydraulic conductivity (m/s)
UG-BH-02	97.0 – 103.0	Saprock	0.03	3×10^{-9}
UG-BH-03	60.0 – 64.0	Saprock	0.01	1×10^{-9}
UG-BH-03	65.0 – 72.0	Saprock	0.01	1×10^{-9}
UG-BH-04	54.0 – 59.0	Saprock	1.1	1.1×10^{-7}
UG-BH-04	63.0 – 68.0	Saprock	0.04	4×10^{-9}
UG-BH-04	72.0 – 77.0	Primary Rock	1.2	1.2×10^{-7}
UG-BH-04	91.0 – 102.0	Primary Rock	< 0.01	$< 1 \times 10^{-9}$

4.4. Installation of piezometers

Following drilling of each surface borehole, three strain gauge piezometers were installed in the borehole at varying depths to monitor groundwater pressures at 6 hr intervals. The boreholes were backfilled with a bentonite grout mix using an approximate ratio (by weight) of 0.3 bentonite to 1 cement to 3 water. The piezometers were connected to telemetry data loggers which enable remote monitoring of the groundwater pressure. Table 4 shows the elevation and hydrogeological unit in which each of each of the piezometers is located. The piezometers are labelled as SG1, SG2 or SG3 in each borehole.

Table 4: Piezometer elevations

Borehole	Piezometer SG1 elevation (m AHD)	Unit	Piezometer SG2 elevation (m AHD)	Unit	Piezometer SG3 elevation (m AHD)	Unit
UG-BH-01	189.1	Lake Sediments	174.1	Lake Sediments	134.1	Saprock
UG-BH-02	190.8	Lake Sediments	160.8	Saprolite	103.8	Primary Rock ¹
UG-BH-03	188.9	Lake Sediments	173.9	Saprolite	133.9	Primary Rock ¹
UG-BH-04	188.8	Lake Sediments	158.8	Saprock	102.3	Primary Rock

1. Piezometer located approximately at the top of primary rock unit

4.4.1. Allowance for flooding of Lake Cowal

The telemetry data loggers for the piezometers were installed on poles approximately 1.9 m high. In the event of flooding of Lake Cowal, flood water level is likely to rise above the top of the pole. For this reason, the mounting for the telemetry data loggers has been designed to be easily removable and a tether is provided for attachment to a floatable raft (designed by others), as explained below.

A marine grade stainless steel wire tether has been secured to the top of each post. This may be attached to a floatable raft to allow temporary floating of the data loggers during flooding of Lake Cowal. The data loggers have been mounted onto weather resistant plywood, which can be cut, drilled, screwed or modified as needed to attach to the raft when required. The plywood is mounted onto the pole by two U-bolts, which can be removed with a spanner.

Care was taken when installing the telemetry boxes to ensure that the readout unit was watertight. It should be noted however that it is not designed to be submerged. Figure 7 shows details of the telemetry installation.



Figure 7: Telemetry installation

In the event that Lake Cowal floods, the following steps will need to be taken to ensure that the piezometers continue to function and are not damaged:

1. Cable ties securing wire coils to mounting hooks to be cut to free the cables.
2. Telemetry data logger and plywood backing to be removed from pole by undoing the two large U-bolts with a spanner and then attached to a floatable raft (designed by others).
3. Stainless steel tether to be attached to floatable raft by the eyelet found at the end of the tether.
4. Piezometer cables to be secured to the top of the pole at the D-shackle using a cable tie or similar. This is to reduce the risk of the piezometer cables wrapping around the pole as the floatable raft moves in the water.

After completing the steps above there should be approximately 2 to 3 m of stainless steel wire tether and approximately 3 to 4 m of piezometer cables between the top of the pole and the floatable raft. The stainless steel tether is shorter than the piezometer cables to ensure that the piezometer cables do not carry the load of anchoring the floatable raft.

4.5. Piezometer installation in exploration decline

12 strain gauge piezometers were installed in the exploration decline to gain an understanding of the effect of tunnelling induced stress changes on permeability in the surrounding rock. Three locations were chosen for piezometer installation at different depths in the exploration decline; one in the 1017 arm (17 m AHD), one in the 985 arm (-15 m AHD) and one in the 951 arm (-49 m AHD). These locations are named UG-DHBH-01, UG-DHBH-02 and UG-DHBH-03 respectively. The locations are shown in Figure 5.

At each location, four boreholes were drilled into the surrounding walls of the tunnel at an angle of 20 degrees below horizontal. A Coffey field engineer was not present for the drilling of these boreholes and did not observe any recovered core. The boreholes were drilled to depths of 2 m, 4 m, 6 m and 10 m at each location.

A strain gauge piezometer was placed in the base of each borehole before grouting to the surface using an approximate bentonite grout mix ratio (by weight) of 0.25 bentonite to 1 cement to 2.5 water. One week after grouting, the piezometers were connected to data loggers. This data was downloaded by a Coffey field engineer after three weeks of monitoring.

4.6. Mapping of seepage into exploration decline

A Coffey field engineer conducted a site walkover and drive through the exploration decline on 27 February and 28 February 2020. Observed areas of seepage or dampness of the exposed tunnel face were recorded. Where possible, the rate of seepage was assessed by timing the rate of filling up of a bucket. The entire decline was observed except for a small area where drilling was in progress at the eastern end of the 985 arm. The floor of the decline was not observed as it was not practicable to obtain a clear view due to the presence of disturbed ground, mud or water.

A map showing observed seepage is provided in Appendix D and discussed in Section 5.1.1.

5. Discussion of results

5.1. Aquifer parameters

The field methodology for packer testing was described in Section 4.3. Packer test results are plotted against depth in Figure 8.

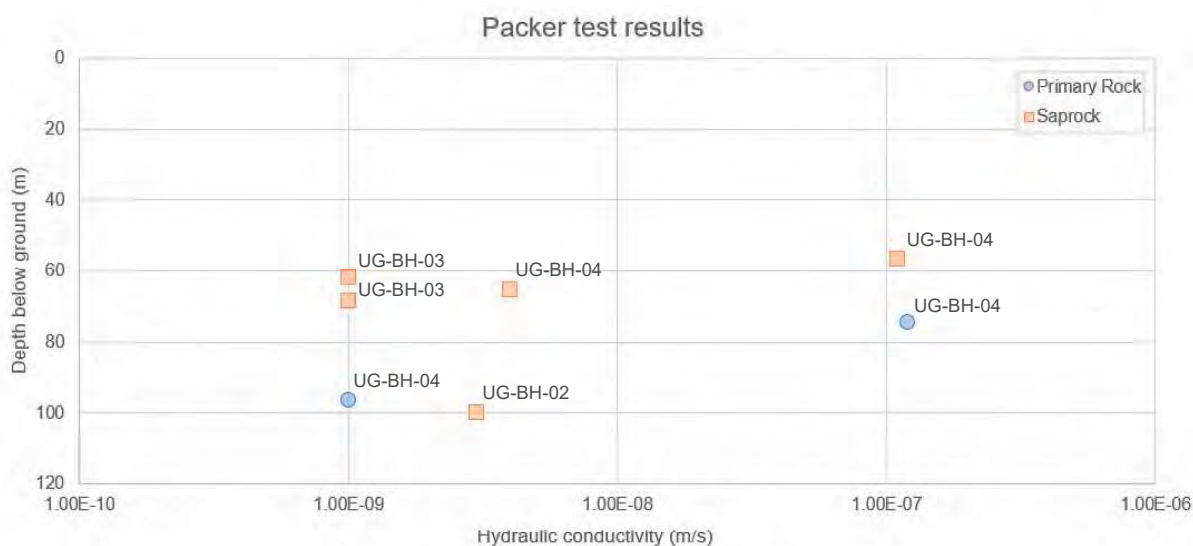

Figure 8: Packer test results

It can be seen from the figure that the majority of packer test results showed hydraulic conductivities below 1×10^{-8} m/s. Three tests showed negligible to no flow and a value of 1×10^{-9} m/s was ascribed to these as a practical minimum level of detection.

5.1.1. Seepage into the exploration decline

Seepage into the exploration decline was mapped by a Coffey field engineer, as described in Section 4.6. The observed seepage and estimated inflows are shown in Table 5. A map showing observed seepage is provided in Appendix D.

Table 5: Observed seepage in exploration decline (27 February 2020)

Category	Approximate flow rate (L/min)	Number observed	Total flow (L/min)	Total flow (L/s)
VVH	25	1	25.0	0.42
VH	7.5	3	22.5	0.38
H	3	6	18.0	0.30
L	1.5	7	10.5	0.18
M	0.2	47	9.4	0.16
TOTAL			85.4	1.42

The seepage inflow rate classifications listed in Table 5 were adopted for this project to cover the range of inflows observed. Even the highest observed inflow rate is considered modest. The total aggregate observed flow into the decline is approximately 1.4 L/s. Doubling this value, to account for areas where seepage could not be observed due to mud and water and for approximations in

assessing flow rates, results in an estimated groundwater inflow rate of 2.8 L/s into the whole exploration decline on 27 February 2020.

An assessment of the hydraulic conductivity required to produce this flow rate was carried out. This was done by assuming an equivalent length tunnel in uniform rock with the same approximate groundwater heads and tunnel elevation profile. The resulting hydraulic conductivity was found to be close to 5.5×10^{-9} m/s. This result is similar to the median of the packer testing results (3.5×10^{-9} m/s) which are shown in Table 3 and Figure 8.

Note that this method of assessing hydraulic conductivity is approximate, however groundwater inflow rates into the exploration decline serve as an excellent guide to expected groundwater into other excavations nearby such as the proposed stopes and access tunnels for the CGO Underground Development.

Details of the hydraulic conductivity assessment are provided in Appendix D.

Influence of faults

The Glenfiddich fault was observed to cross the exploration decline near its southern portal. The fault zone consists of slightly more fractured rock compared to the surrounding rock and is up to approximately 8 m wide. Some areas of higher inflow were found adjacent to the fault. However, many other areas of higher inflow were found in joints not apparently connected to the Glenfiddich fault or other faults. The widespread and intersecting nature of jointing and faulting observed inside the decline makes it impractical to describe the effect of individual faults on the groundwater flow regime.

It does not appear that the Glenfiddich fault is providing a significant preferential conduit for groundwater when it is considered amongst the surrounding fractured rock at the scale of the CGO Underground Development.

5.2. Geophysics - Natural gamma logging

Natural gamma logging was conducted to assess the variability in the Lake Sediments. The fieldwork methodology was discussed in Section 4.2.

The results of the natural gamma logging are provided in Appendix B. The charts in Appendix B show measured gamma ray emissions from the soil and/or rock versus depth. To assist in interpreting the results, drilling core loss percentages have been plotted as logged in the field. Areas of higher drilling core loss are likely to be areas where the materials contain higher sand content and are often associated with lower GR (natural gamma radiation rate) values. Overall, depths with GR values lower than 80 are interpreted to be likely to contain higher levels of sand.

The following summarises the depths where GR values less than 80 were observed in the Lake Sediments:

- UG-BH-01 (Lake Sediments 0.0 m – 18.9 m):
 - 8.0 m – 8.5 m
 - 15.2 m – 15.8 m
 - 17.0 m – 18.4 m

2.5 m out of 18.9 m (13 %) thickness of Lake Sediments at UG-BH-01 observed to have GR values less than 80.

- UG-BH-02 (Lake Sediments 0.0 m – 20.5 m):
 - 13.0 m – 20.5 m

7.5 m out of 20.5 m (37 %) thickness of Lake Sediments at UG-BH-02 observed to have GR values less than 80.

- UG-BH-04 (Lake Sediments 0.0 m – 10.6 m):

0.0 m out of 10.6 m (0 %) thickness of Lake Sediments at UG-BH-04 observed to have GR values less than 80.

It should be noted that these areas are likely to have a higher sand content than other parts of the Lake Sediments, although the material is likely to still be predominantly a clay. Figure 9 shows a core photo from UG-BH-02. The core run from 14.7 m – 17.8 m, shown in the lower half of the core box, was in a zone where natural gamma GR values were approximately 65 on average. Despite this, the material is still predominantly clay.

Clean sands or gravels were not found in the Lake Sediments in any of the four boreholes.



Figure 9: UG-BH-02 core photo showing Lake Sediments (13.0 m - 18.9 m)

The natural gamma logging, along with the borehole logs, show the Lake Sediments to be predominantly a sandy clay with occasional zones or bands of higher sand content. No obviously high permeability zones (such as clean sands or gravels) were identified in either the borehole logs or the natural gamma logging.

Note that, following advice from Evolution Mining, in-situ permeability testing was not undertaken on the Lake Sediments to minimise risk of environmental contamination of the lake bed with testing water or fluid.

5.3. Exploration boreholes

Exploration borehole data was provided in digital format by Evolution Mining. The provided exploration boreholes cover an area of approximately 1.3 km (east-west) by 2.5 km (north-south) above the proposed underground mine. This information was used to obtain elevations for the interfaces between the three hydrogeological units described in Section 3.2. A contouring process (kriging) was used to interpolate between boreholes. Figure 10 shows the interpreted thickness of the Lake Sediments and Saprolite units from the exploration boreholes. The depth below ground refers to the ground surface prior to the open pit being excavated.

In the area above the CGO Underground Development, the thickness of the Lake Sediments can be seen from Figure 10 to be approximately between 15 m and 34 m. It is worth noting that the base of the Lake Sediments can be challenging to identify from borehole drilling. The Saprolite immediately below the base of the Lake Sediments, as observed in UG-BH-01, UG-BH-02, UG-BH-03 and UG-BH-04, often contained sandy clays which appeared very similar to those encountered in the Lake Sediments.

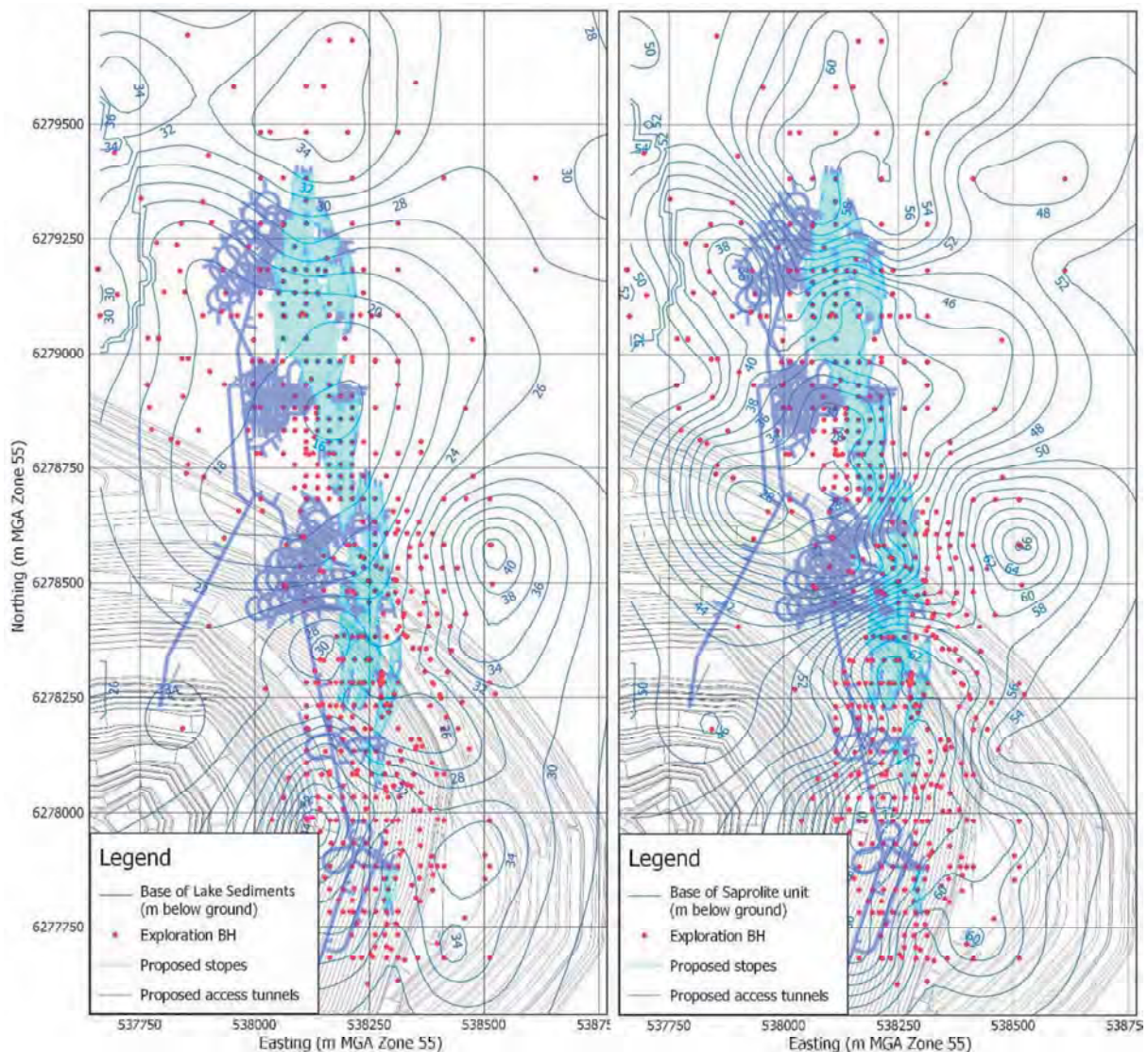

Figure 10: Depth to the base of Lake Sediments and Saprolite units as interpreted from exploration boreholes

5.4. Geophysics - gravity survey interpretation

In April 2019, a detailed geophysical gravity survey commissioned by Evolution Mining was carried out by Haines Surveys Pty Ltd (Haines) and presented in a report (Haines Surveys, 2019).

The gravity survey data was provided to Coffey for further analysis and modelling which was carried out in November 2019. The proprietary software program Potent was used. Potent is a Windows-based application in an interactive framework for 3D modelling of potential field data (i.e. gravity and/or magnetics).

The interpretation of the data was calibrated against exploration borehole data, from which the thickness of the Lake Sediments had been observed directly. The majority of boreholes were clustered over the edge of the central eastern part of the survey area above the proposed underground mine. However, four boreholes were obtained from the National Groundwater Information System (NGIS) public borehole database. These boreholes provide lithology logs showing the base of the Lake Sediments. The boreholes are GW703223, GW703225, GW704031 and GW704252. Their locations are shown in Figure 11. There were a number of other boreholes in the NGIS public borehole database for the area covered by the gravity survey, however these did not

provide lithological logs identifying the base of lake sediments or provided logs which were deemed of lesser accuracy and were excluded.

The exploration and selected publicly available boreholes provide a reasonable constraint of the interpretation out to approximately 3 km east of the open pit. The interpreted levels of the base of the Lake Sediments from the gravity survey data are shown in Figure 11 and the interpreted thickness is shown in Figure 12. Figure 12 shows that the Lake Sediments have a thickness generally ranging between 30 m and 50 m in the area east of the open pit, except for a notable area extending north east of the open pit, where the thickness ranges between approximately 15 m and 25 m .

The gravity survey interpretation for areas outside those shown on Figure 11 did not converge in the analysis and so these areas were excluded from reporting. Note also that the gravity survey interpretation was done prior to the fieldwork covered in this report and did not take into account the results of boreholes UG-BH-01, UG-BH-02, UG-BH-03 and UG-BH-04.

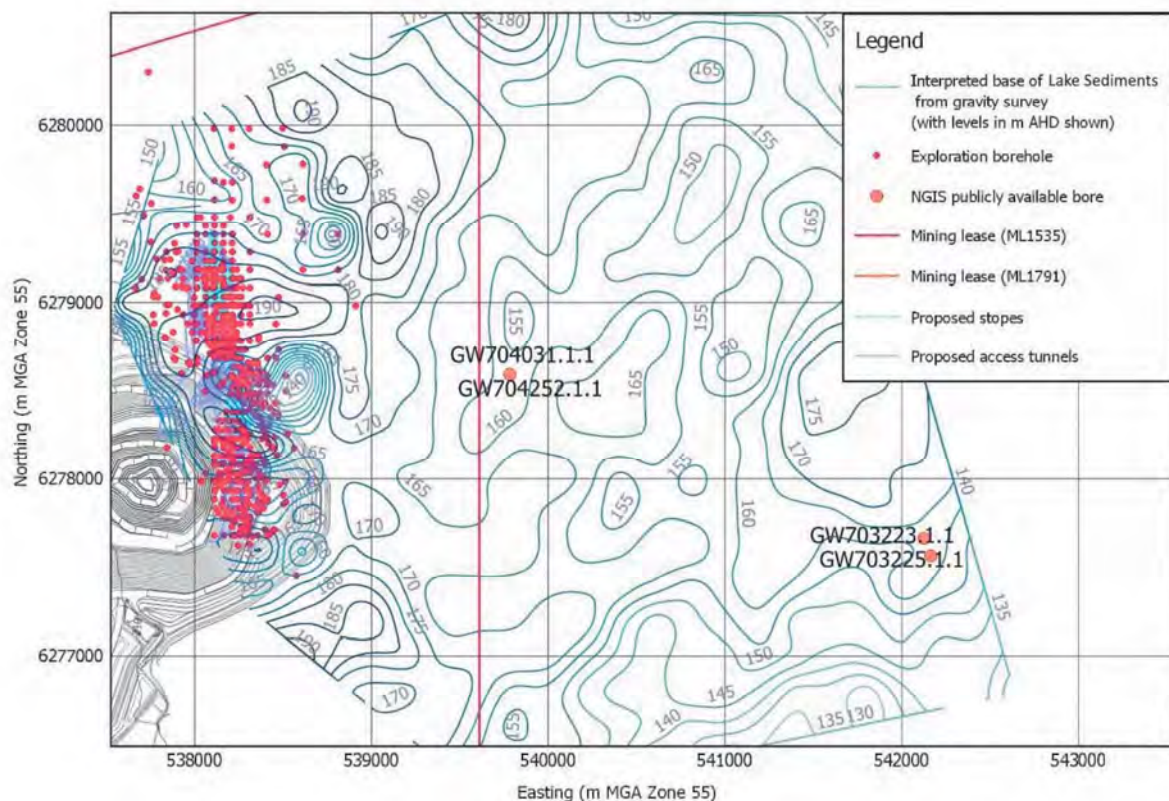

Figure 11: Elevation of the base of the Lake Sediments from gravity survey interpretation

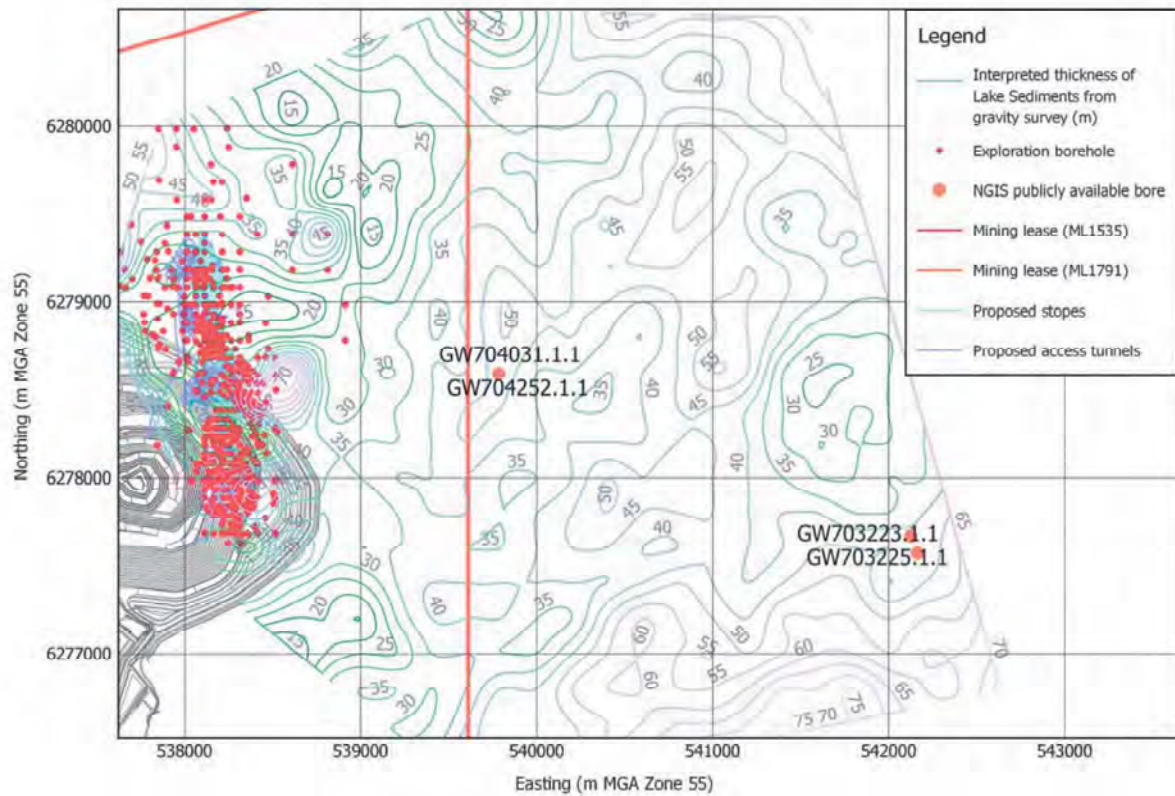

Figure 12: Thickness of the Lake Sediments from gravity survey interpretation

5.5. Groundwater levels

Groundwater monitoring was installed at UG-BH-01, UG-BH-02, UG-BH-03 and UG-BH-04. The locations of these boreholes are shown in Figure 5. At each of these locations, three strain gauge piezometers were installed at different depths, as discussed in Section 4.4 and shown in Table 4.

In addition, groundwater monitoring data was provided by Evolution Mining for eight existing piezometers located at boreholes PDB1, PZ13 and PDB3. The locations of these boreholes are also shown in Figure 5. The elevations and hydrogeological units in which these piezometers are screened or located in are shown in Table 6.

Table 6: Existing piezometers near the proposed underground development

Borehole	Piezometer elevation (m AHD)	Unit
PDB1A	126.3	Saprock
PDB1B	194.3	Lake Sediments
PZ13-1	83.8	Primary Rock
PZ13-2	128.8	Saprock
PZ13-3	143.8	Saprock
PZ13-4	171.8	Saprolite
PDB3A	110.3	Saprock
PDB3B	181.2	Lake Sediments

A hydrogeological assessment was undertaken by Coffey to assess potential impacts on the groundwater system under the proposed Cowal Gold Operations (CGO) Underground Development (Coffey Report No. SYDGE206418-3-AD, dated 3 February 2020 (Draft)) (the numerical groundwater model). From the numerical groundwater model, modelled groundwater heads (at January 2020) were extracted at the location of each of the new and existing monitoring locations described above.

The numerical groundwater model did not take into account the exploration decline. Differences between modelled and observed heads may therefore be the result of either effects on groundwater levels associated with the exploration decline and / or may provide an indication of areas where model calibration could be improved.

Modelled and observed groundwater heads at the new and existing groundwater monitoring locations are shown in Figure 13 and Figure 14, respectively. Groundwater heads in the figures are shown for the following dates:

- Modelled groundwater heads are shown for 1 January 2020.
- Observed groundwater heads at UG-BH-01, UG-BH-02, UG-BH-03 and UG-BH-04 are shown for 2 March 2020.
- Observed groundwater heads at PDB1A, PDB1B, PDB3A and PDB3B are shown for 6 December 2020.
- Observed groundwater heads at PZ13 are shown for 1 November 2020.

Groundwater monitoring hydrographs for each of these locations are provided in Appendix E.

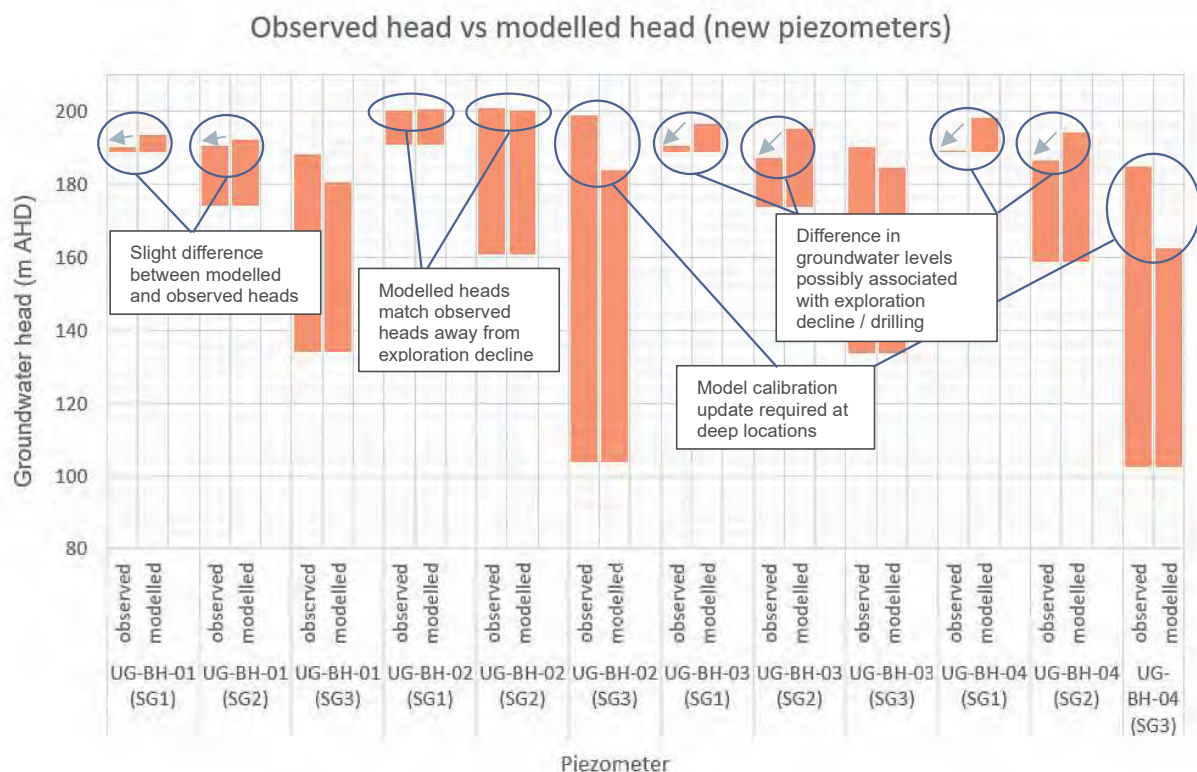

Figure 13: Observed and modelled groundwater head at new piezometers (base of column shows sensor elevation, top of column shows groundwater heads)

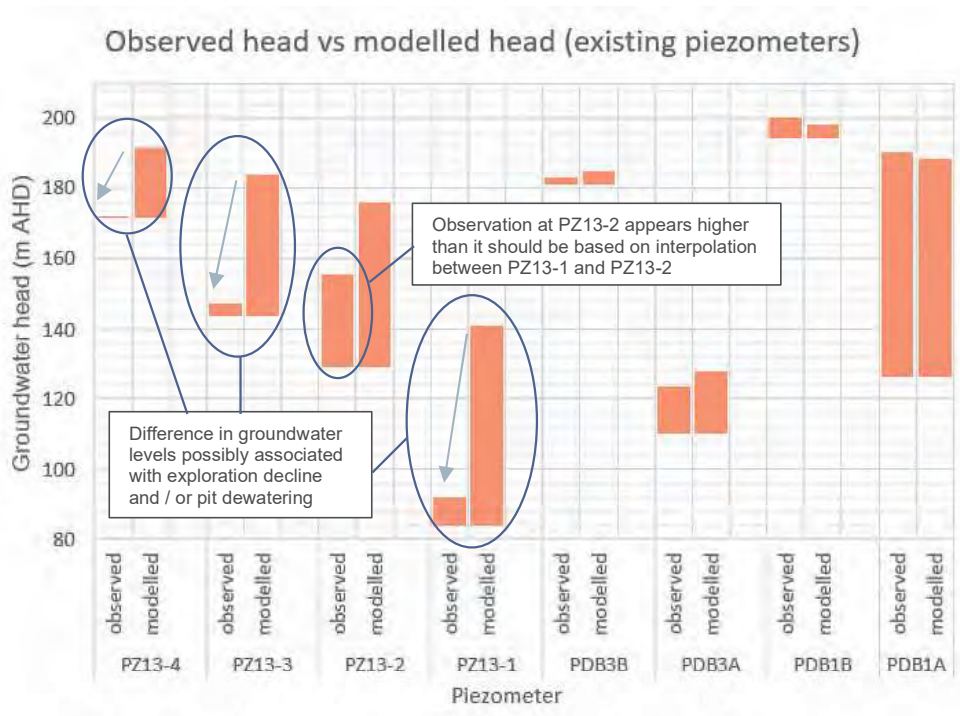

Figure 14: Observed and modelled groundwater head at existing piezometers (base of column shows sensor elevation, top of column shows groundwater heads)

The following observations are made based on the information shown in Figure 7 and Figure 8:

- Groundwater levels away from the decline in the two shallow piezometers at UG-BH-02 provide a close match to predictions from the numerical groundwater model. This indicates that model calibration appears reasonable for the shallower hydrogeological units.
- Groundwater levels for the deeper piezometers observed at all of the new monitoring locations are higher than those predicted by the numerical groundwater model by between 4 m and 10 m. This indicates the potential for improvement to model calibration for the deeper hydrogeological units.
- Groundwater levels observed at UG-BH-03 and UG-BH-04 show that the underground decline and associated exploration drilling may have resulted in groundwater levels in the Lake Sediments and Saprolite being below the modelled values. At UG-BH-01, which is located approximately 250 m west of the exploration decline, differences between modelled and observed heads in the Lake Sediments and Saprolite are less than 2 m.
- Groundwater levels observed at PZ13 are between 10 m and 40 m lower than those predicted by the groundwater model. This large difference might be explained by exploration drilling targeting a shallower zone of potential gold bearing ore in this location and by the higher elevation of the exploration decline in this area. Alternatively, groundwater levels may be affected by rock defects creating preferred pathways towards the open cut mine void.

5.6. Groundwater levels adjacent to the exploration decline

As discussed in Section 4.5, strain gauge piezometers were installed at three locations in the exploration decline to monitor groundwater pressures at 2 m, 4 m, 6 m and 10 m distance into the surrounding rock from the tunnel walls. Groundwater monitoring results at the three locations in the underground decline are shown in Figure 15, Figure 16 and Figure 17. The results are summarised as below:

- At UG-BH-01, all of the piezometers were dry over the monitoring period. Pressures of between approximately -2 kPa and -5 kPa observed over the final two weeks of monitoring, indicating unsaturated conditions.
- At UG-BH-02, the piezometer at 2 m distance was dry, showing atmospheric pressure variation. The piezometers at 4 m, 6 m and 10 m showed relatively stable pressures of approximately 1.0 kPa, 0.8 kPa and 10.6 kPa respectively over the final two weeks of monitoring.
- At UG-BH-03, the piezometers at 2 m and 10 m were showing pressures of -95 kPa over the whole monitoring period, indicating that more time may have been required for stabilisation as nearby air pockets fill with water. Interestingly, the piezometer at 4 m distance was similarly showing pressures of -95 kPa for the first two weeks of monitoring until rising rapidly to a near atmospheric condition, as can be observed over the last two days of monitoring. The piezometer at 6 m distance was approximately constant over the monitoring period at around 7 kPa and showed variability similar to atmospheric conditions.

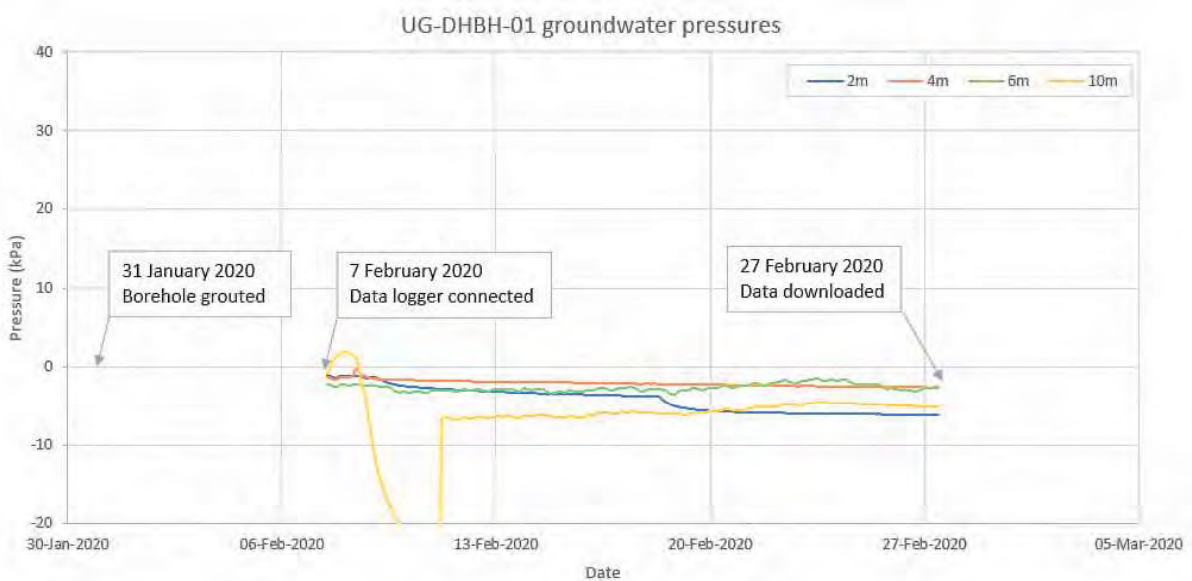

Figure 15: Groundwater pressures at UG-DHBH-01

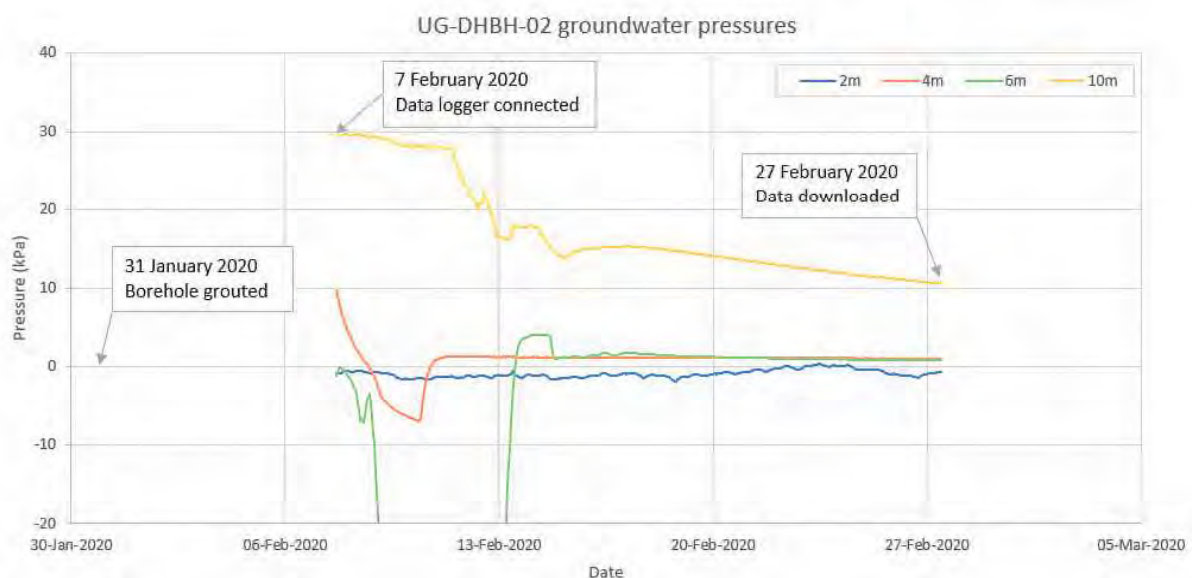

Figure 16: Groundwater pressures at UG-DHBH-02

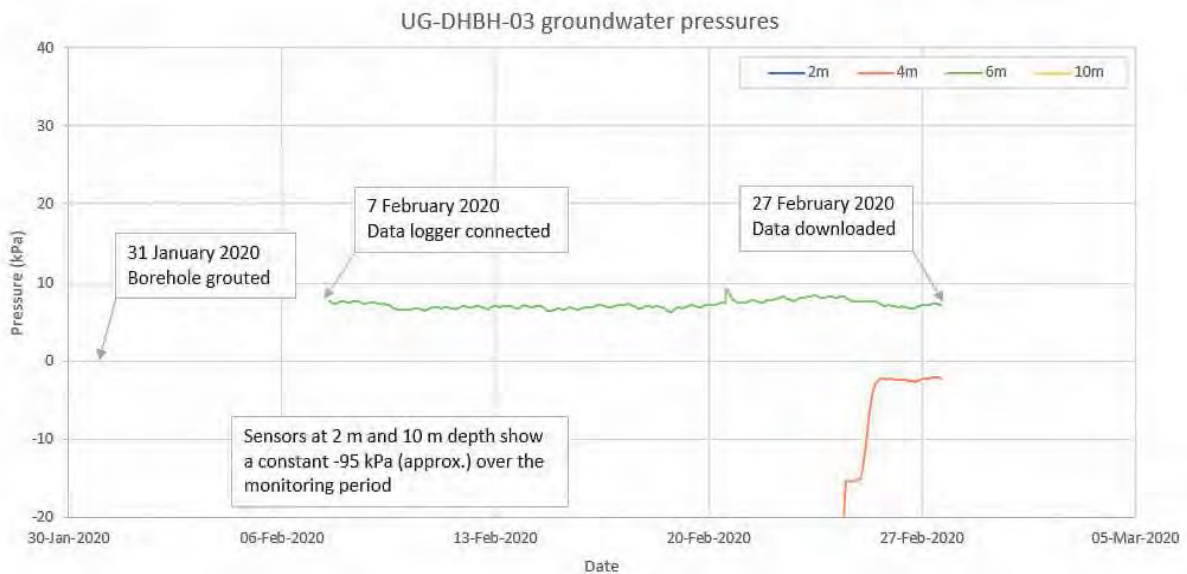

Figure 17: Groundwater pressures at UG-DHBH-03

The results shown in Figure 15, Figure 16 and Figure 17 indicate that groundwater pressures within 10 m from the exploration decline are generally dry or in an unsaturated condition. UG-DHBH-02 is the only location where the majority (three out of four) of piezometers show positive groundwater pressures. At this location, the groundwater pressure at 2m, 4m and 6m is negligible or unsaturated and the groundwater pressure at 10 m is 10 kPa and was falling slowly on 27 February 2020. This may indicate that changes in hydraulic conductivity as a result of stress changes due to tunnelling extend out to somewhere between 6 m and 10 m from the exploration decline at that location. Note however that the drilling of exploration boreholes may have resulted in localised changes to permeability and a lowering of groundwater pressures near the tunnel face in this area and also at UG-DHBH-01 and UG-DHBH-03.

6. Summary

The results of fieldwork, undertaken to improve understanding of groundwater conditions in support of the hydrogeological assessment for the CGO Underground Development EIS, have been presented. These include borehole logs, geophysical testing, permeability testing, seepage mapping in the exploration decline and groundwater level monitoring in the area of the proposed CGO Underground Development. The main results from the fieldwork are summarised below:

- The Lake Sediments in the area near the proposed CGO Underground Development were observed to be between 10.6 m and 20.5 m thick at the four boreholes drilled. The Lake Sediments comprised predominantly clays to sandy clays containing minor bands or layers with higher sand content. No clean sands or gravels were observed.
- Following advice from Evolution Mining, in-situ permeability testing was not undertaken on the Lake Sediments to minimise risk of environmental contamination of the lake bed with testing water / fluid.
- In-situ borehole water pressure testing (packer testing) on the Saprock and Primary Rock units, in combination with seepage observations into the exploration decline, showed the horizontal hydraulic conductivity of these units to be in the order of 1×10^{-9} m/s to 1×10^{-8} m/s.
- 12 piezometers were installed at four locations near the proposed CGO Underground development. Initial monitoring results indicate that:

- Observed groundwater levels at UG-BH-02, located away from the exploration decline, provide a reasonable match to predictions from the numerical groundwater model for piezometers in the Lake Sediments and Saprolite
- Observed groundwater levels at the deepest piezometers in all four locations are higher than those predicted by the numerical groundwater model by between 4 m and 10 m. This indicates the potential for improvement to model calibration for the deeper hydrogeological units. It is recommended to update model calibration in any future revision to the numerical groundwater model
- 12 piezometers were installed at three locations in the exploration decline. Observations at these piezometers indicate that groundwater pressures within 10 m of the excavation decline are generally zero or unsaturated. Results at UG-DHBH-02 which showed groundwater pressure at 10 m distance from the exploration decline and very low to zero pressure at 6 m, 4m and 2m distance suggest that changes to hydraulic conductivity as a result of stress changes due to tunnelling have extended out to somewhere between 6 m and 10 m from the exploration decline at that location.
- Observations of seepage into the exploration decline showed some areas of higher inflow associated with the Glenfiddich fault. Many other areas of higher inflow were found in joints not necessarily connected to faults. The widespread and intersecting nature of jointing and faulting observed inside the decline makes it impractical to describe the impact of individual faults on the groundwater flow regime.

7. References

Barrick Australia Limited (2010). Saline Groundwater Assessment – Cowra Aquifer, Cowal Gold Mine, West Wyalong, NSW, Final Report, Project No. BARR010, October 2010.

Belknap, W.B., Dewan, J.T., Kirkpatrick, C.V., Motts, W.E., Peason, A.J., Rabson, W.R., 1959. API calibration facility for nuclear logs, in: Drilling and Production Practice. American Petroleum Institution, pp. 289-316.

Burgess, P.J. (1983) In-situ permeability testing in soil and rock, in: In-situ Testing for Geotechnical Investigations. Balkema, Rotterdam.

Coffey Services Australia Pty Ltd (2006). Cowal Gold Mine, Groundwater Supply Modelling Study, Model Calibration. Report No. S21910/2AK, 15 September 2006.

Haines Surveys (2019), Lake Cowal 3 Gravity Survey, Evolution Mining Ltd, April - May 2019, Job No. 1906.

Appendix A – Borehole logs

Engineering Log - Borehole

client: **EMM CONSULTING PTY LTD**
 principal: **Evolution Mining**
 project: **CGO UNDERGROUND DEVELOPMENT EIS**
 location: **COWAL GOLD OPERATIONS**

Borehole ID: **UG-BH-01**
 sheet: 1 of 9
 project no. **754-SYDGE206418-3**
 date started: **29 Jan 2020**
 date completed: **01 Feb 2020**
 logged by: **TBM**
 checked by: **PLV**

position: Not Specified surface elevation: Not Specified angle from horizontal: -90°
 drill model: Sandvik DE840, Truck mounted drilling fluid: PAK-R casing diameter: PVC150/PW

drilling information				material substance								
method & support	penetration	water	samples & field tests	RL (m)	depth (m)	graphic log	soil group symbol	material description	moisture condition	consistency / relative density	hand penetrometer (kPa)	structure and additional observations
AD/T	150-RPM (As Screwing)	Not Observable			0.0			Sandy GRAVEL: fine to coarse grained, sub-angular to angular, red/brown, sand is fine to coarse grained, with cobbles and boulders up to 300mm.			100 200 300 400	Outer bund wall
					1.0			Soil not observed from 1.0m to 5.8m due to drilling schedule and method				
					5.7			Start of coring at 5.7m				LACUSTRINE SOIL Core Run (5.7-5.9 m): 100% recovery Core Run (5.9-7.7 m): 100% recovery
					6.0			Sandy CLAY: high plasticity, pale grey mottled orange and red/brown, with fine to coarse grained, sub-angular gravel.				
					7.7			CORE LOSS 1.4M.				Core Run (7.7-9.3 m): 13% recovery

method AD auger drilling* AS auger screwing* HA hand auger W washbore * bit shown by suffix e.g. AD/T B blank bit T TC bit V V bit	support M mud N nil C casing penetration no resistance ranging to refusal water 10-Oct-12 water level on date shown water inflow water outflow	samples & field tests B bulk disturbed sample D disturbed sample E environmental sample SS split spoon sample U## undisturbed sample ##mm diameter HP hand penetrometer (kPa) N standard penetration test (SPT) N* SPT - sample recovered Nc SPT with solid cone VS vane shear; peak/remoulded (kPa) R refusal HB hammer bouncing	soil group symbol & soil description based on AS 1726:2017 moisture condition D dry M moist W wet Wp plastic limit WI liquid limit	consistency / relative density VS very soft S soft F firm St stiff VSt very stiff H hard Fb friable VL very loose L loose MD medium dense D dense VD very dense
--	--	--	---	--

CDF_0_9_07_LIBRARY.GLB rev:AU Log_COF_BOREHOLE: NON CORED 754-SYDGE206418-3.GPJ <<DrawingFile>> 27/03/2020 10:48

Engineering Log - Borehole

client: **EMM CONSULTING PTY LTD**
principal: **Evolution Mining**
project: **CGO UNDERGROUND DEVELOPMENT EIS**
location: **COWAL GOLD OPERATIONS**

Borehole ID: **UG-BH-01**
sheet: 2 of 9
project no: **754-SYDGE206418-3**
date started: **29 Jan 2020**
date completed: **01 Feb 2020**
logged by: **TBM**
checked by: **PLV**

position: Not Specified surface elevation: Not Specified angle from horizontal: -90°
drill model: Sandvik DE840, Truck mounted drilling fluid: PAK-R casing diameter: PVC150/PW

drilling information				material substance								
method & support	penetration	water	samples & field tests	RL (m)	depth (m)	graphic log	soil group symbol	material description	moisture condition	consistency / relative density	hand penetrometer (kPa)	structure and additional observations
								CORE LOSS 1.4M. (continued)				LACUSTRINE SOIL
					9.0			Sandy CLAY: high plasticity, pale grey mottled orange and red/brown, with fine to coarse grained, sub-angular gravel.				Core Run (9.3-9.7 m): 75% recovery
					10.0			Gravelly CLAY: high plasticity, pale grey mottled red/brown, gravel is fine to coarse grained and sub-angular, with fine to coarse grained sand.				Core Run (9.7-12.2 m): 44% recovery
								CORE LOSS 1.4M.				
					11.0			Sandy CLAY: high plasticity, pale grey, sand is fine to coarse grained, with fine to medium grained, sub-angular to sub-rounded gravel.				
					12.0			11.7 m: lenses of clayey SAND, fine to medium grained, red/brown appearing				
								CLAYEY SAND: fine to medium grained, red/brown.				Core Run (12.2-12.8 m): 83% recovery
					13.0			Sandy CLAY: high plasticity, pale grey mottled red/brown, sand is fine to coarse grained, trace fine to medium grained, sub-angular to sub-rounded gravel.				Core Run (12.8-13.4 m): 100% recovery
					14.0			14.5 m: becoming red/brown mottled pale grey				Core Run (13.4-14.4 m): 100% recovery
					15.0			CORE LOSS 0.9M.				Core Run (14.4-14.8 m): 100% recovery
												Core Run (14.8-15.3 m): 100% recovery
												Core Run (15.3-16.6 m): 31% recovery

method AD auger drilling* AS auger screwing* HA hand auger W washbore * bit shown by suffix e.g. AD/T B blank bit T TC bit V V bit	support M mud C casing N nil penetration  no resistance ranging to refusal water 10-Oct-12 water level on date shown water inflow water outflow	samples & field tests B bulk disturbed sample D disturbed sample E environmental sample SS split spoon sample U## undisturbed sample ##mm diameter HP hand penetrometer (kPa) N standard penetration test (SPT) N* SPT - sample recovered Nc SPT with solid cone VS vane shear; peak/remoulded (kPa) R refusal HB hammer bouncing	soil group symbol & soil description based on AS 1726:2017 moisture condition D dry M moist W wet Wp plastic limit WI liquid limit	consistency / relative density VS very soft S soft F firm St stiff VSt very stiff H hard Fb friable VL very loose L loose MD medium dense D dense VD very dense
---	---	--	---	--

CDF_0_9_07_LIBRARY.GLB rev:AU Log COF BOREHOLE: NON CORED 754-SYDGE206418-3.GPJ <<DrawingFile>> 27/03/2020 10:48

Engineering Log - Borehole

client: **EMM CONSULTING PTY LTD**
principal: **Evolution Mining**
project: **CGO UNDERGROUND DEVELOPMENT EIS**
location: **COWAL GOLD OPERATIONS**

Borehole ID: **UG-BH-01**
sheet: 3 of 9
project no. **754-SYDGE206418-3**
date started: **29 Jan 2020**
date completed: **01 Feb 2020**
logged by: **TBM**
checked by: **PLV**

position: Not Specified surface elevation: Not Specified angle from horizontal: -90°
drill model: Sandvik DE840, Truck mounted drilling fluid: PAK-R casing diameter: PVC150/PW

drilling information				material substance								
method & support	penetration	water	samples & field tests	RL (m)	depth (m)	graphic log	soil group symbol	material description	moisture condition	consistency / relative density	hand penetrometer (kPa)	structure and additional observations
								CORE LOSS 0.9M. (continued)				LACUSTRINE SOIL
					17.0			Sandy CLAY: high plasticity, pale grey mottled red/brown, sand is fine to coarse grained, trace fine to medium grained, sub-angular to sub-rounded gravel.				
					18.0			CORE LOSS 2.3M.				Core Run (17.2-17.7 m): 0% recovery
					18.0							Core Run (17.7-18.1 m): 0% recovery
					19.0			caved in material recovered from above 18.9m suggests core loss is likely in a layer of gravelly SAND, fine to coarse grained, red/br. gravel is sub-angular to sub-rounded, fine to coarse grained, with clay				Core Run (18.1-18.2 m): 0% recovery Core Run (18.2-18.5 m): 0% recovery
					19.0			Sandy CLAY: high plasticity, red/brown mottled pale grey and orange, trace fine to medium grained, sub-angular gravel.				Core Run (18.5-18.6 m): 100% recovery Core Run (18.6-18.9 m): 100% recovery
					20.0			19.5 m: becoming pale grey mottled red/brown				RESIDUAL SOIL
					20.0			19.7 m: pockets of extremely weathered, iron staining, fine to coarse grained, sub-angular gravel appearing				Core Run (18.9-19.4 m): 100% recovery Core Run (19.4-20.7 m): 100% recovery
					21.0							Core Run (20.7-21.3 m): 100% recovery
					22.0							Core Run (21.3-23.1 m): 100% recovery
					23.0							Core Run (23.1-25.1 m): 100% recovery
					23.0			23.1 m: pockets of red/brown iron stained clay becoming larger and more frequent				

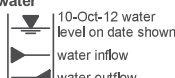
method AD auger drilling* AS auger screwing* HA hand auger W washbore * bit shown by suffix e.g. AD/T B blank bit T TC bit V V bit	support M mud C casing penetration  no resistance ranging to refusal water  10-Oct-12 water level on date shown water inflow water outflow	samples & field tests B bulk disturbed sample D disturbed sample E environmental sample SS split spoon sample U## undisturbed sample ##mm diameter HP hand penetrometer (kPa) N standard penetration test (SPT) N* SPT - sample recovered Nc SPT with solid cone VS vane shear, peak/remoulded (kPa) R refusal HB hammer bouncing	soil group symbol & soil description based on AS 1726:2017 moisture condition D dry M moist W wet Wp plastic limit WI liquid limit	consistency / relative density VS very soft S soft F firm St stiff VSt very stiff H hard Fb friable VL very loose L loose MD medium dense D dense VD very dense
--	---	--	---	--

CDF_0_9_07_LIBRARY.GLB rev:AU Log COF BOREHOLE: NON CORED 754-SYDGE206418-3.GPJ <<DrawingFile>> 27/03/2020 10:48

Engineering Log - Borehole

DRAFT

Borehole ID. **UG-BH-01**
 sheet: 4 of 9
 project no. **754-SYDGE206418-3**
 date started: **29 Jan 2020**
 date completed: **01 Feb 2020**
 logged by: **TBM**
 checked by: **PLV**

client: **EMM CONSULTING PTY LTD**
 principal: **Evolution Mining**
 project: **CGO UNDERGROUND DEVELOPMENT EIS**
 location: **COWAL GOLD OPERATIONS**

position: Not Specified surface elevation: Not Specified angle from horizontal: -90°
 drill model: Sandvik DE840, Truck mounted drilling fluid: PAK-R casing diameter: PVC150/PW

drilling information				material substance								
method & support	penetration	water	samples & field tests	RL (m)	depth (m)	graphic log	soil group symbol	material description	moisture condition	consistency / relative density	hand penetrometer (kPa)	structure and additional observations
HQ C		Not Observable			25.0 26.0 27.0 28.0 29.0 30.0 31.0			Sandy CLAY: high plasticity, red/brown mottled pale grey and orange, trace fine to medium grained, sub-angular gravel. <i>(continued)</i> 27.5 m: becoming red/brown with pockets of pale grey			100 200 300 400	RESIDUAL SOIL Core Run (25.1-27.3 m): 100% recovery Core Run (27.3-30.3 m): 100% recovery Core Run (30.3-31.6 m): 100% recovery Core Run (31.6-33.3 m): 100% recovery

CDF_0_9_07_LIBRARY.GLB rev:AU Log COF BOREHOLE: NON CORED 754-SYDGE206418-3.GPJ <<DrawingFile>> 27/03/2020 10:48

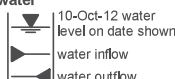
method AD auger drilling* AS auger screwing* HA hand auger W washbore * bit shown by suffix e.g. AD/T B blank bit T TC bit V V bit	support M mud N nil C casing penetration  no resistance ranging to refusal water  10-Oct-12 water level on date shown water inflow water outflow	samples & field tests B bulk disturbed sample D disturbed sample E environmental sample SS split spoon sample U## undisturbed sample ##mm diameter HP hand penetrometer (kPa) N standard penetration test (SPT) N* SPT - sample recovered Nc SPT with solid cone VS vane shear; peak/remoulded (kPa) R refusal HB hammer bouncing	soil group symbol & soil description based on AS 1726:2017 moisture condition D dry M moist W wet Wp plastic limit WI liquid limit	consistency / relative density VS very soft S soft F firm St stiff VSt very stiff H hard Fb friable VL very loose L loose MD medium dense D dense VD very dense
--	--	--	---	--

Engineering Log - Borehole

DRAFT

Borehole ID: **UG-BH-01**
 sheet: 5 of 9
 project no: **754-SYDGE206418-3**
 date started: **29 Jan 2020**
 date completed: **01 Feb 2020**
 logged by: **TBM**
 checked by: **PLV**

client: **EMM CONSULTING PTY LTD**
 principal: **Evolution Mining**
 project: **CGO UNDERGROUND DEVELOPMENT EIS**
 location: **COWAL GOLD OPERATIONS**

position: Not Specified surface elevation: Not Specified angle from horizontal: -90°
 drill model: Sandvik DE840, Truck mounted drilling fluid: PAK-R casing diameter: PVC150/PW

drilling information				material substance								
method & support	penetration	water	samples & field tests	RL (m)	depth (m)	graphic log	soil group symbol	material description	moisture condition	consistency / relative density	hand penetrometer (kPa)	structure and additional observations
AD	1				33.0			Sandy CLAY: high plasticity, red/brown mottled pale grey and orange, trace fine to medium grained, sub-angular gravel. <i>(continued)</i>				RESIDUAL SOIL Core Run (33.3-35.1 m): 100% recovery Core Run (35.1-37.3 m): 100% recovery Core Run (37.3-39.3 m): 100% recovery
	2				34.0							
	3				35.0							
					36.0			Gravelly CLAY: high plasticity, pale grey mottled red/brown and orange, gravel is fine to coarse grained and angular, with fine to coarse grained sand (Extremely to highly weathered rock, very low to low strength, indistinct bedding/foliation at 70°-80°, minor pockets of ironstone/iron-enriched rock).				EXTREMELY WEATHERED ROCK Core Run (39.3-42.0 m): 100% recovery
					37.0							
					38.0							
					39.0							

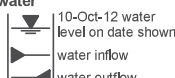
method AD auger drilling* AS auger screwing* HA hand auger W washbore	support M mud N nil C casing penetration  water 	samples & field tests B bulk disturbed sample D disturbed sample E environmental sample SS split spoon sample U## undisturbed sample ##mm diameter HP hand penetrometer (kPa) N standard penetration test (SPT) N* SPT - sample recovered Nc SPT with solid cone VS vane shear, peak/remoulded (kPa) R refusal HB hammer bouncing	soil symbol & soil description based on AS 1726:2017 moisture condition D dry M moist W wet Wp plastic limit WI liquid limit	consistency / relative density VS very soft S soft F firm St stiff VSt very stiff H hard Fb friable VL very loose L loose MD medium dense D dense VD very dense
--	--	--	---	--

CDF_0_9_07_LIBRARY.GLB rev:AU Log_COF_BOREHOLE: NON CORED 754-SYDGE206418-3.GPJ <<DrawingFile>> 27/03/2020 10:48

Engineering Log - Borehole

DRAFT

Borehole ID. **UG-BH-01**
 sheet: 6 of 9
 project no. **754-SYDGE206418-3**
 date started: **29 Jan 2020**
 date completed: **01 Feb 2020**
 logged by: **TBM**
 checked by: **PLV**

client: **EMM CONSULTING PTY LTD**
 principal: **Evolution Mining**
 project: **CGO UNDERGROUND DEVELOPMENT EIS**
 location: **COWAL GOLD OPERATIONS**

position: Not Specified surface elevation: Not Specified angle from horizontal: -90°
 drill model: Sandvik DE840, Truck mounted drilling fluid: PAK-R casing diameter: PVC150/PW

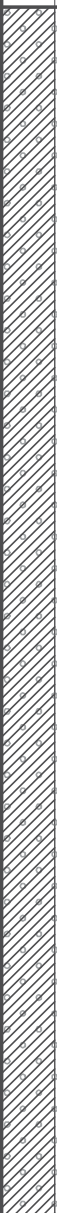
drilling information				material substance								
method & support	penetration	water	samples & field tests	RL (m)	depth (m)	graphic log	soil group symbol	material description	moisture condition	consistency / relative density	hand penetrometer (kPa)	structure and additional observations
HQ C Not Observable					41.0 42.0 43.0 44.0 45.0 46.0 47.0			Gravelly CLAY: high plasticity, pale grey mottled red/brown and orange, gravel is fine to coarse grained and angular, with fine to coarse grained sand (Extremely to highly weathered rock, very low to low strength, indistinct bedding/foliation at 70°-80°, minor pockets of ironstone/iron-enriched rock). <i>(continued)</i> 45.1 m: bands of highly weathered, very low strength, red/brown rock appearing			100 200 300 400	EXTREMELY WEATHERED ROCK Core Run (42.0-45.0 m): 100% recovery Core Run (45.0-48.1 m): 100% recovery

CDF_0_9_07_LIBRARY.GLB rev:AU Log COF BOREHOLE: NON CORED 754-SYDGE206418-3.GPJ <<DrawingFile>> 27/03/2020 10:48

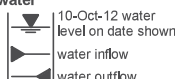
method AD auger drilling* AS auger screwing* HA hand auger W washbore * bit shown by suffix e.g. AD/T B blank bit T TC bit V V bit	support M mud N nil C casing penetration  no resistance ranging to refusal water  10-Oct-12 water level on date shown water inflow water outflow	samples & field tests B bulk disturbed sample D disturbed sample E environmental sample SS split spoon sample U## undisturbed sample ##mm diameter HP hand penetrometer (kPa) N standard penetration test (SPT) N* SPT - sample recovered Nc SPT with solid cone VS vane shear; peak/remoulded (kPa) R refusal HB hammer bouncing	soil group symbol & soil description based on AS 1726:2017 moisture condition D dry M moist W wet Wp plastic limit WI liquid limit	consistency / relative density VS very soft S soft F firm St stiff VSt very stiff H hard Fb friable VL very loose L loose MD medium dense D dense VD very dense
--	--	--	---	--



Engineering Log - Borehole

DRAFT

Borehole ID: **UG-BH-01**
 sheet: 7 of 9
 project no: **754-SYDGE206418-3**
 date started: **29 Jan 2020**
 date completed: **01 Feb 2020**
 logged by: **TBM**
 checked by: **PLV**

client: **EMM CONSULTING PTY LTD**
 principal: **Evolution Mining**
 project: **CGO UNDERGROUND DEVELOPMENT EIS**
 location: **COWAL GOLD OPERATIONS**

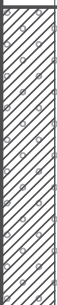
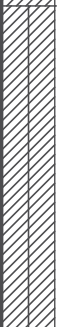
position: Not Specified surface elevation: Not Specified angle from horizontal: -90°
 drill model: Sandvik DE840, Truck mounted drilling fluid: PAK-R casing diameter: PVC150/PW

drilling information				material substance								
method & support	penetration	water	samples & field tests	RL (m)	depth (m)	graphic log	soil group symbol	material description	moisture condition	consistency / relative density	hand penetrometer (kPa)	structure and additional observations
AD	1				49.0			Gravelly CLAY: high plasticity, pale grey mottled red/brown and orange, gravel is fine to coarse grained and angular, with fine to coarse grained sand (Extremely to highly weathered rock, very low to low strength, indistinct bedding/foliation at 70°-80°, minor pockets of ironstone/iron-enriched rock). <i>(continued)</i>				EXTREMELY WEATHERED ROCK Core Run (48.1-51.2 m): 100% recovery
					50.0			Silty CLAY: high plasticity, red/brown mottled pale grey and pale brown, with fine to medium grain sand, trace fine to coarse grained, sub-angular gravel (Highly weathered, low strength rock, massive, pale grey & pale brown).				HIGHLY WEATHERED ROCK Core Run (51.2-54.0 m): 100% recovery
					52.0			52.2 m: becoming pale brown mottled pale grey and red/brown				
					53.0							
					54.0			ANDESITE: fine to medium grained, pale brown/pale grey, highly weathered, low strength, micro-fractures throughout minor bands of very low strength rock.				HIGHLY WEATHERED IGNEOUS ROCK - POSSIBLY ANDESITE Core Run (54.0-57.0 m): 100% recovery
					55.0							

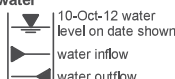
method AD auger drilling* AS auger screwing* HA hand auger W washbore	support M mud N nil C casing penetration  no resistance ranging to refusal water  10-Oct-12 water level on date shown water inflow water outflow	samples & field tests B bulk disturbed sample D disturbed sample E environmental sample SS split spoon sample U## undisturbed sample ##mm diameter HP hand penetrometer (kPa) N standard penetration test (SPT) N* SPT - sample recovered Nc SPT with solid cone VS vane shear, peak/remoulded (kPa) R refusal HB hammer bouncing	soil group symbol & soil description based on AS 1726:2017 moisture condition D dry M moist W wet Wp plastic limit WI liquid limit	consistency / relative density VS very soft S soft F firm St stiff VSt very stiff H hard Fb friable VL very loose L loose MD medium dense D dense VD very dense
--	--	--	---	--

CDF_0_9_07_LIBRARY.GLB rev:AU Log COF BOREHOLE: NON CORED 754-SYDGE206418-3.GPJ <<DrawingFile>> 27/03/2020 10:48

Engineering Log - Borehole

client: **EMM CONSULTING PTY LTD**
principal: **Evolution Mining**
project: **CGO UNDERGROUND DEVELOPMENT EIS**
location: **COWAL GOLD OPERATIONS**

Borehole ID: **UG-BH-01**
sheet: 8 of 9
project no: **754-SYDGE206418-3**
date started: **29 Jan 2020**
date completed: **01 Feb 2020**
logged by: **TBM**
checked by: **PLV**

position: Not Specified surface elevation: Not Specified angle from horizontal: -90°
drill model: Sandvik DE840, Truck mounted drilling fluid: PAK-R casing diameter: PVC150/PW

drilling information				material substance								
method & support	penetration	water	samples & field tests	RL (m)	depth (m)	graphic log	soil group symbol	material description	moisture condition	consistency / relative density	hand penetrometer (kPa)	structure and additional observations
HQ	C	Not Observable			57.0			ANDESITE: fine to medium grained, pale brown/pale grey, highly weathered, low strength, micro-fractures throughout minor bands of very low strength rock. <i>(continued)</i>				HIGHLY WEATHERED ROCK
					58.0							Core Run (57.0-58.9 m): 95% recovery
					59.0							Core Run (58.9-60.8 m): 100% recovery
					60.0							Core Run (60.8-62.6 m): 100% recovery
					61.0							Core Run (62.6-63.3 m): 100% recovery
					62.0							Core Run (63.3-66.3 m): 50% recovery
					63.0			CORE LOSS 1.5M.				

method AD auger drilling* AS auger screwing* HA hand auger W washbore * bit shown by suffix e.g. AD/T B blank bit T TC bit V V bit	support M mud C casing penetration no resistance ranging to refusal water 10-Oct-12 water level on date shown water inflow water outflow	samples & field tests B bulk disturbed sample D disturbed sample E environmental sample SS split spoon sample U## undisturbed sample ##mm diameter HP hand penetrometer (kPa) N standard penetration test (SPT) N* SPT - sample recovered Nc SPT with solid cone VS vane shear; peak/remoulded (kPa) R refusal HB hammer bouncing	soil group symbol & soil description based on AS 1726:2017 moisture condition D dry M moist W wet Wp plastic limit WI liquid limit	consistency / relative density VS very soft S soft F firm St stiff VSt very stiff H hard Fb friable VL very loose L loose MD medium dense D dense VD very dense
--	---	--	---	--

CDF_0_9_07_LIBRARY.GLB rev:AU Log COF BOREHOLE: NON CORED 754-SYDGE206418-3.GPJ <<DrawingFile>> 27/03/2020 10:48

Engineering Log - Borehole

client: **EMM CONSULTING PTY LTD**
principal: **Evolution Mining**
project: **CGO UNDERGROUND DEVELOPMENT EIS**
location: **COWAL GOLD OPERATIONS**

Borehole ID: **UG-BH-01**
sheet: 9 of 9
project no: **754-SYDGE206418-3**
date started: **29 Jan 2020**
date completed: **01 Feb 2020**
logged by: **TBM**
checked by: **PLV**

position: Not Specified surface elevation: Not Specified angle from horizontal: -90°
drill model: Sandvik DE840, Truck mounted drilling fluid: PAK-R casing diameter: PVC150/PW

drilling information				material substance								
method & support	penetration	water	samples & field tests	RL (m)	depth (m)	graphic log	soil group symbol	material description	moisture condition	consistency / relative density	hand penetrometer (kPa)	structure and additional observations
								CORE LOSS 1.5M. (continued)				HIGHLY WEATHERED ROCK
					65.0			ANDESITE: fine to medium grained, pale brown/pale grey, highly weathered, low strength, micro-fractures throughout minor bands of very low strength rock.				
					66.0							
					67.0			ANDESITE: medium grained, pale brown, massive, very low to low strength, extremely to highly weathered, micro-fractures throughout.				Core Run (66.3-66.4 m): 100% recovery Core Run (66.4-66.7 m): 100% recovery Core Run (66.7-68.2 m): 100% recovery
					68.0							Core Run (68.2-69.3 m): 100% recovery
					69.0							Core Run (69.3-70.7 m): 100% recovery
					70.0			70.0 m: bands of highly weathered, very low strength rock up to 100mm thick appearing				
					71.0							Core Run (70.7-72.0 m): 100% recovery
Borehole UG-BH-01 terminated at 72.0 m Target depth												

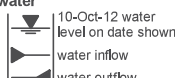
method AD auger drilling* AS auger screwing* HA hand auger W washbore * bit shown by suffix e.g. AD/T B blank bit T TC bit V V bit	support M mud C casing penetration  no resistance ranging to refusal water  10-Oct-12 water level on date shown water inflow water outflow	samples & field tests B bulk disturbed sample D disturbed sample E environmental sample SS split spoon sample U## undisturbed sample ##mm diameter HP hand penetrometer (kPa) N standard penetration test (SPT) N* SPT - sample recovered Nc SPT with solid cone VS vane shear; peak/remoulded (kPa) R refusal HB hammer bouncing	soil group symbol & soil description based on AS 1726:2017 moisture condition D dry M moist W wet Wp plastic limit WI liquid limit	consistency / relative density VS very soft S soft F firm St stiff VSt very stiff H hard Fb friable VL very loose L loose MD medium dense D dense VD very dense
--	---	--	---	--

CDF_0_9_07_LIBRARY.GLB rev:AU Log COF BOREHOLE: NON CORED 754-SYDGE206418-3.GPJ <<DrawingFile>> 27/03/2020 10:48

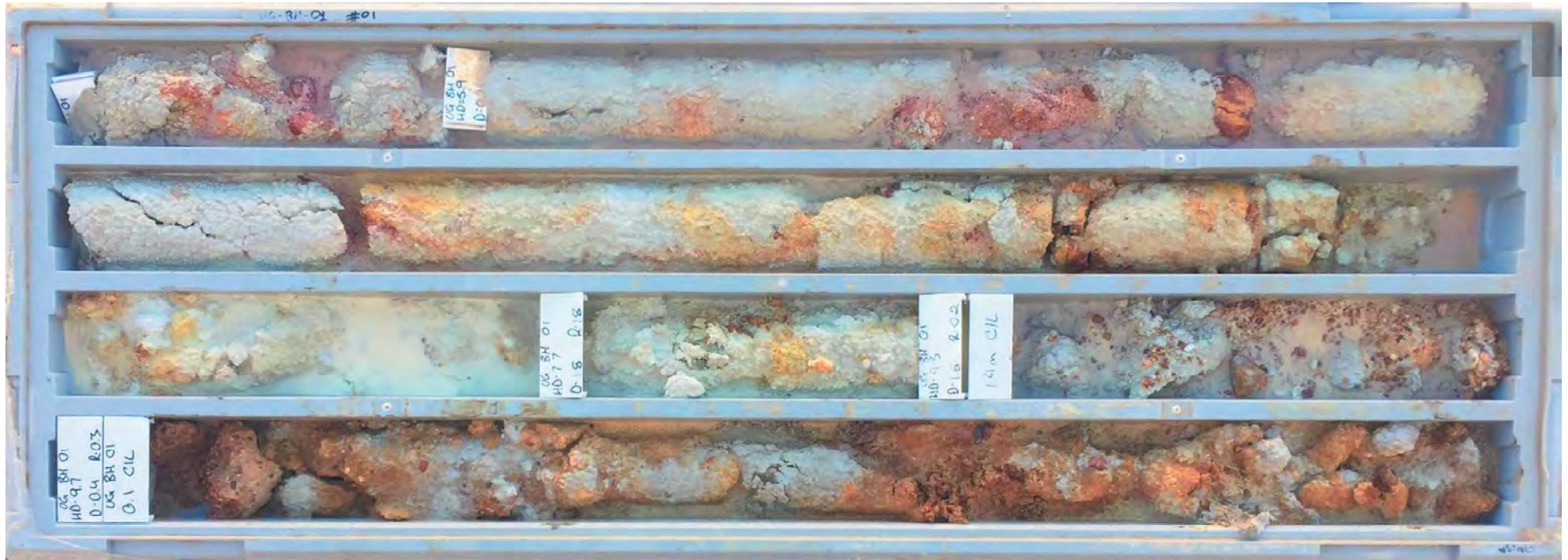

UG-BH-01 5.70 - 12.20 m

drawn	TBM		client:	EMM CONSULTING PTY LTD		
approved	AO		project:	CGO UNDERGROUND DEVELOPMENT EIS COWAL GOLD OPERATIONS		
date	23/03/2020		title:	CORE PHOTOGRAPH UG-BH-01		
scale	N.T.S.		project no:	754-SYDGE206418-3	fig no:	FIGURE 1
original size	A4		rev:	A		



UG-BH-01 12.20 - 18.50 m

drawn	TBM		client: EMM CONSULTING PTY LTD		
approved	AO		project: CGO UNDERGROUND DEVELOPMENT EIS COWAL GOLD OPERATIONS		
date	23/03/2020		title: CORE PHOTOGRAPH UG-BH-01		
scale	N.T.S.		project no: 754-SYDGE206418-3	fig no: FIGURE 2	rev: A
original size	A4				



UG-BH-01 18.50 - 21.40 m

drawn	TBM		client: EMM CONSULTING PTY LTD		
approved	AO		project: CGO UNDERGROUND DEVELOPMENT EIS COWAL GOLD OPERATIONS		
date	23/03/2020		title: CORE PHOTOGRAPH UG-BH-01		
scale	N.T.S.		project no: 754-SYDGE206418-3	fig no: FIGURE 3	rev: A
original size	A4				

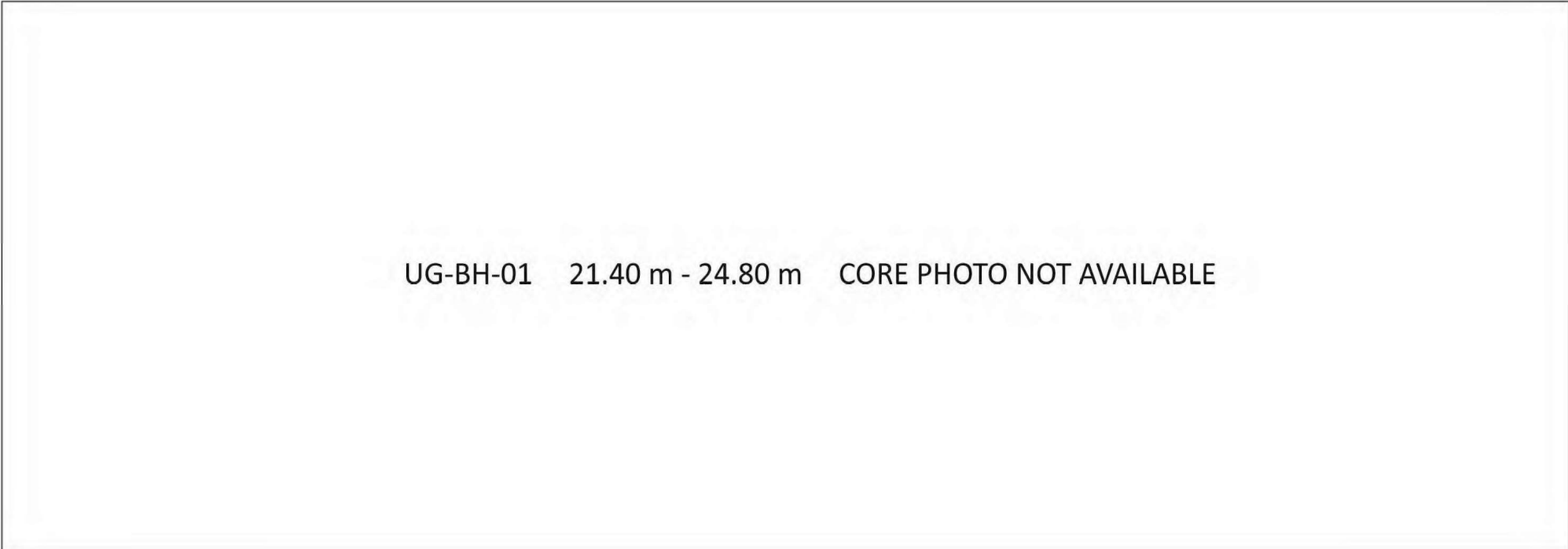

UG-BH-01 21.40 m - 24.80 m CORE PHOTO NOT AVAILABLE

UG-BH-01 21.40 - 24.50 m

drawn	TBM		client:	EMM CONSULTING PTY LTD		
approved	AO		project:	CGO UNDERGROUND DEVELOPMENT EIS COWAL GOLD OPERATIONS		
date	23/03/2020		title:	CORE PHOTOGRAPH UG-BH-01		
scale	N.T.S.		project no:	754-SYDGE206418-3	fig no:	FIGURE 4
original size	A4		rev:	A		



UG-BH-01 24.50 - 28.50 m

drawn	TBM		client:	EMM CONSULTING PTY LTD		
approved	AO		project:	CGO UNDERGROUND DEVELOPMENT EIS COWAL GOLD OPERATIONS		
date	23/03/2020		title:	CORE PHOTOGRAPH UG-BH-01		
scale	N.T.S.		project no:	754-SYDGE206418-3	fig no:	FIGURE 5
original size	A4		rev:	A		



UG-BH-01 28.50 - 31.60 m

drawn	TBM		client:	EMM CONSULTING PTY LTD		
approved	AO		project:	CGO UNDERGROUND DEVELOPMENT EIS COWAL GOLD OPERATIONS		
date	23/03/2020		title:	CORE PHOTOGRAPH UG-BH-01		
scale	N.T.S.		project no:	754-SYDGE206418-3	fig no:	FIGURE 6
original size	A4				rev:	A



UG-BH-01 31.60 - 35.60 m

drawn	TBM		client: EMM CONSULTING PTY LTD		
approved	AO		project: CGO UNDERGROUND DEVELOPMENT EIS COWAL GOLD OPERATIONS		
date	23/03/2020		title: CORE PHOTOGRAPH UG-BH-01		
scale	N.T.S.		project no: 754-SYDGE206418-3	fig no: FIGURE 7	rev: A
original size	A4				



UG-BH-01 35.60 - 39.20 m

drawn	TBM		client:	EMM CONSULTING PTY LTD		
approved	AO		project:	CGO UNDERGROUND DEVELOPMENT EIS COWAL GOLD OPERATIONS		
date	23/03/2020		title:	CORE PHOTOGRAPH UG-BH-01		
scale	N.T.S.		project no:	754-SYDGE206418-3	fig no:	FIGURE 8
original size	A4				rev:	A

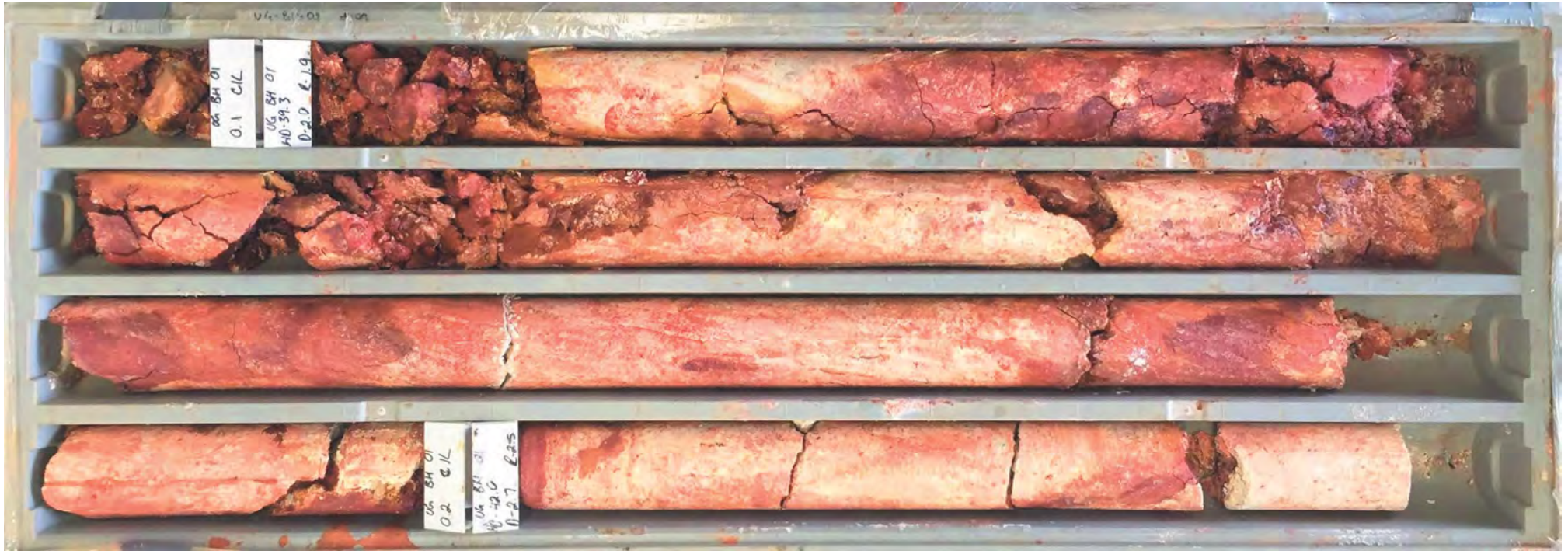

UG-BH-01 39.20 - 42.60 m

drawn	TBM		client:	EMM CONSULTING PTY LTD		
approved	AO		project:	CGO UNDERGROUND DEVELOPMENT EIS COWAL GOLD OPERATIONS		
date	23/03/2020		title:	CORE PHOTOGRAPH UG-BH-01		
scale	N.T.S.		project no:	754-SYDGE206418-3	fig no:	FIGURE 9
original size	A4		rev:	A		

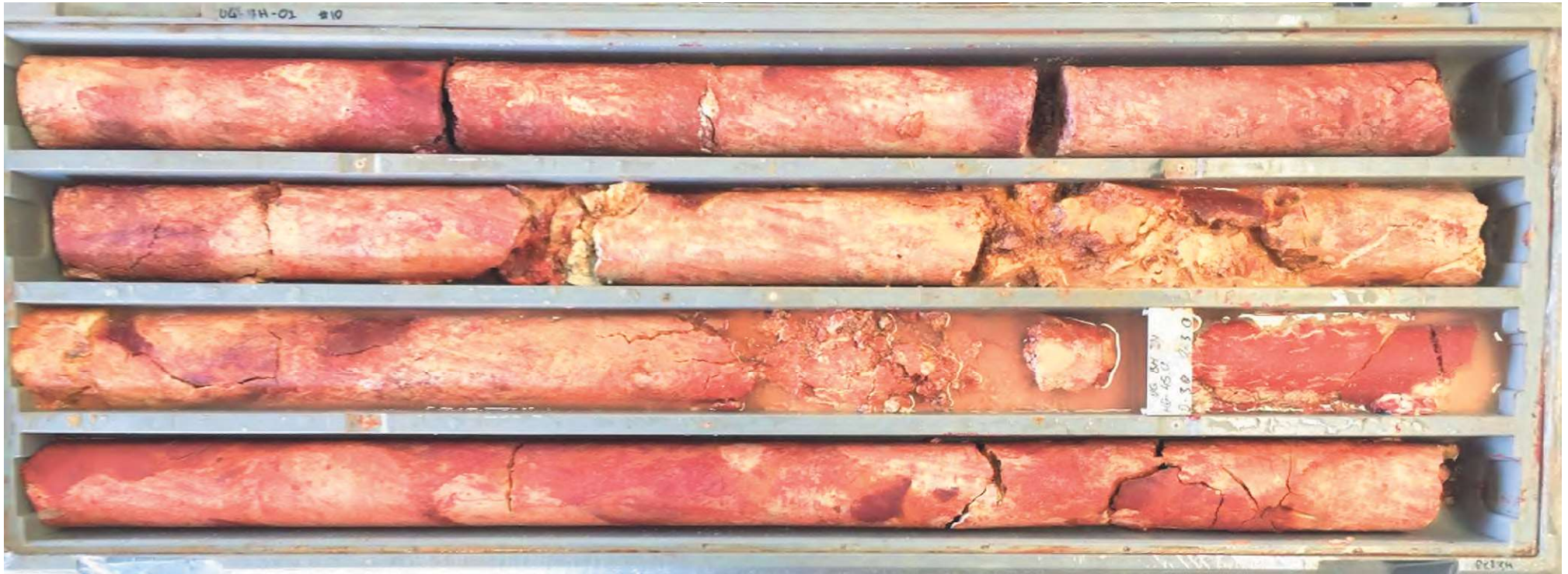

UG-BH-01 42.60 - 45.20 m

drawn	TBM		client:	EMM CONSULTING PTY LTD				
approved	AO		project:	CGO UNDERGROUND DEVELOPMENT EIS COWAL GOLD OPERATIONS				
date	23/03/2020		title:	CORE PHOTOGRAPH UG-BH-01				
scale	N.T.S.		project no:	754-SYDGE206418-3	fig no:	FIGURE 10	rev:	A
original size	A4							

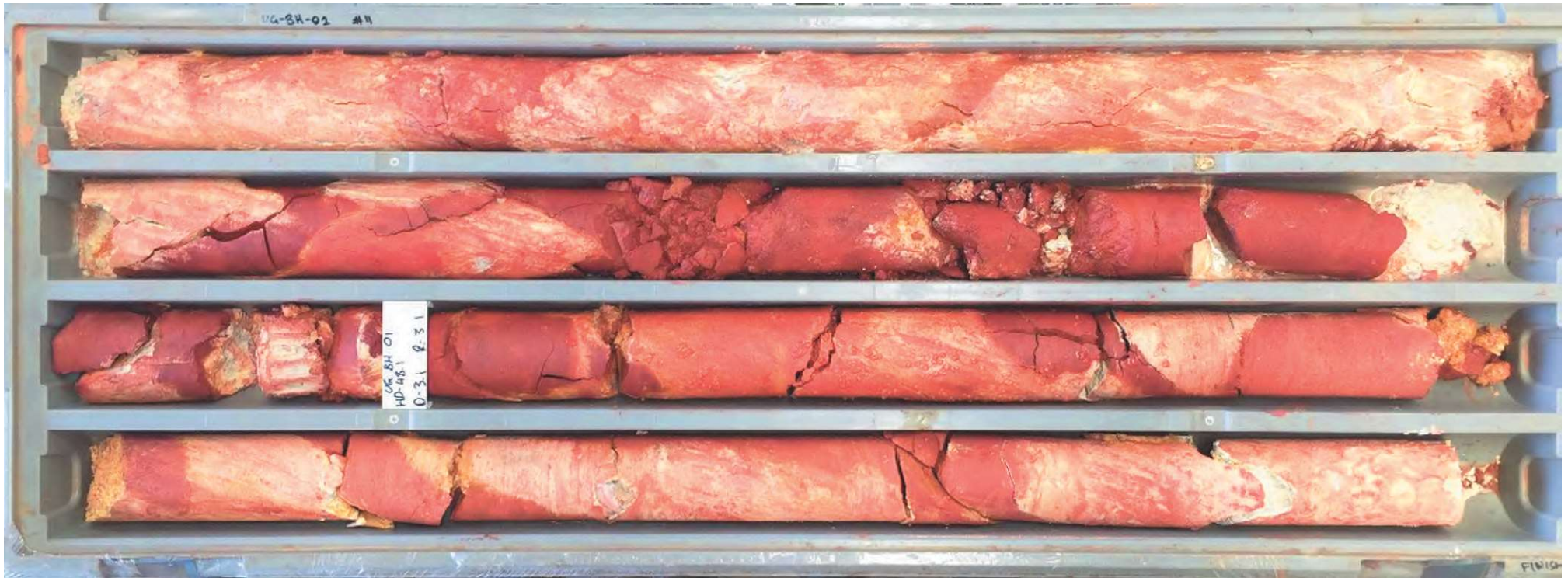

UG-BH-01 45.20 - 49.80 m

drawn	TBM		client:	EMM CONSULTING PTY LTD		
approved	AO		project:	CGO UNDERGROUND DEVELOPMENT EIS COWAL GOLD OPERATIONS		
date	23/03/2020		title:	CORE PHOTOGRAPH UG-BH-01		
scale	N.T.S.		project no:	754-SYDGE206418-3	fig no:	FIGURE 11
original size	A4				rev:	A



UG-BH-01 49.80 - 53.20 m

drawn	TBM		client: EMM CONSULTING PTY LTD		
approved	AO		project: CGO UNDERGROUND DEVELOPMENT EIS COWAL GOLD OPERATIONS		
date	23/03/2020		title: CORE PHOTOGRAPH UG-BH-01		
scale	N.T.S.		project no: 754-SYDGE206418-3	fig no: FIGURE 12	rev: A
original size	A4				



UG-BH-01 53.20 - 56.90 m

drawn	TBM		client: EMM CONSULTING PTY LTD		
approved	AO		project: CGO UNDERGROUND DEVELOPMENT EIS COWAL GOLD OPERATIONS		
date	23/03/2020		title: CORE PHOTOGRAPH UG-BH-01		
scale	N.T.S.		project no: 754-SYDGE206418-3	fig no: FIGURE 13	rev: A
original size	A4				



UG-BH-01 56.90 - 60.20 m

drawn	TBM		client:	EMM CONSULTING PTY LTD		
approved	AO		project:	CGO UNDERGROUND DEVELOPMENT EIS COWAL GOLD OPERATIONS		
date	23/03/2020		title:	CORE PHOTOGRAPH UG-BH-01		
scale	N.T.S.		project no:	754-SYDGE206418-3	fig no:	FIGURE 14
original size	A4		rev:	A		

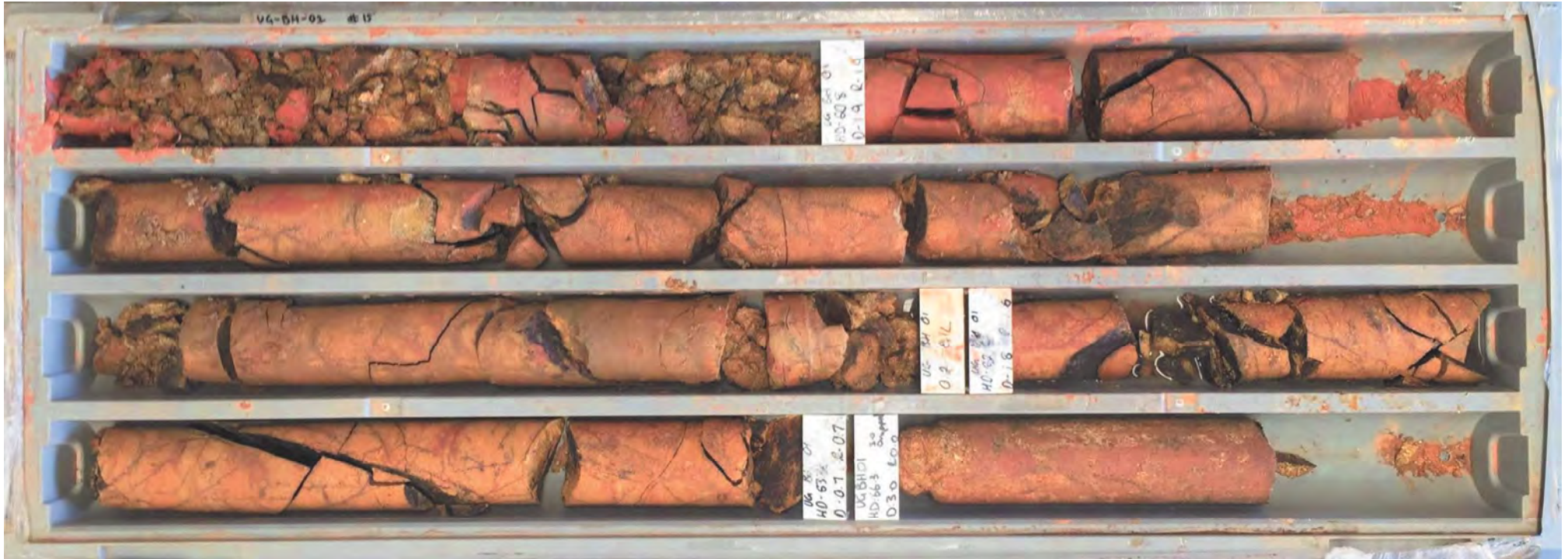

UG-BH-01 60.20 - 63.60 m

drawn	TBM		client:	EMM CONSULTING PTY LTD		
approved	AO		project:	CGO UNDERGROUND DEVELOPMENT EIS COWAL GOLD OPERATIONS		
date	23/03/2020		title:	CORE PHOTOGRAPH UG-BH-01		
scale	N.T.S.		project no:	754-SYDGE206418-3	fig no:	FIGURE 15
original size	A4		rev:	A		



UG-BH-01 63.60 - 68.70 m

drawn	TBM		client:	EMM CONSULTING PTY LTD		
approved	AO		project:	CGO UNDERGROUND DEVELOPMENT EIS COWAL GOLD OPERATIONS		
date	23/03/2020		title:	CORE PHOTOGRAPH UG-BH-01		
scale	N.T.S.		project no:	754-SYDGE206418-3	fig no:	FIGURE 16
original size	A4				rev:	A



UG-BH-01 68.70 - 72.00 m

drawn	TBM		client:	EMM CONSULTING PTY LTD		
approved	AO		project:	CGO UNDERGROUND DEVELOPMENT EIS COWAL GOLD OPERATIONS		
date	23/03/2020		title:	CORE PHOTOGRAPH UG-BH-01		
scale	N.T.S.		project no:	754-SYDGE206418-3	fig no:	FIGURE 17
original size	A4		rev:	A		

Engineering Log - Borehole

client: **EMM CONSULTING PTY LTD**
principal: **Evolution Mining**
project: **CGO UNDERGROUND DEVELOPMENT EIS**
location: **COWAL GOLD OPERATIONS**

Borehole ID: **UG-BH-02**
sheet: 2 of 13
project no: **754-SYDGE206418-3**
date started: **02 Feb 2020**
date completed: **06 Feb 2020**
logged by: **TBM**
checked by: **PLV**

position: Not Specified surface elevation: Not Specified angle from horizontal: -90°
drill model: Sandvik DE840, Truck mounted drilling fluid: PAK-R casing diameter: PVC150/PW

drilling information				material substance								
method & support	penetration	water	samples & field tests	RL (m)	depth (m)	graphic log	soil group symbol	material description	moisture condition	consistency / relative density	hand penetrometer (kPa)	structure and additional observations
								Silty CLAY: high plasticity, grey, with fine to medium grained sand and trace fine to medium grained, sub-angular quartz gravel. <i>(continued)</i>				LACUSTRINE Core Run (9.2-11.6 m): 83% recovery Core Run (11.6-14.7 m): 100% recovery Core Run (14.7-17.8 m): 65% recovery
					9.0			Sandy CLAY: high plasticity, red/brown mottled pale grey, sand is fine to coarse grained, with fine to coarse grained, sub-rounded to sub-angular gravel and silt.				
					10.0			10.9 m: sand content increasing				
					11.0			CORE LOSS 0.4M.				
					12.0			Sandy CLAY: high plasticity, red/brown mottled pale grey, sand is fine to coarse grained, with fine to coarse grained, sub-rounded to sub-angular gravel and silt.				
					13.0			14.2 m: bands of high sand content appearing				
					14.0			CORE LOSS 0.9M.				
					15.0							

method AD auger drilling* AS auger screwing* HA hand auger W washbore * bit shown by suffix e.g. AD/T B blank bit T TC bit V V bit	support M mud C casing N nil penetration  no resistance ranging to refusal water 10-Oct-12 water level on date shown water inflow water outflow	samples & field tests B bulk disturbed sample D disturbed sample E environmental sample SS split spoon sample U## undisturbed sample ##mm diameter HP hand penetrometer (kPa) N standard penetration test (SPT) N* SPT - sample recovered Nc SPT with solid cone VS vane shear, peak/remoulded (kPa) R refusal HB hammer bouncing	soil group symbol & soil description based on AS 1726:2017 moisture condition D dry M moist W wet Wp plastic limit WI liquid limit	consistency / relative density VS very soft S soft F firm St stiff VSt very stiff H hard Fb friable VL very loose L loose MD medium dense D dense VD very dense
--	---	--	---	--

CDF_0_9_07_LIBRARY.GLB rev:AU Log COF BOREHOLE: NON CORED 754-SYDGE206418-3.GPJ <<DrawingFile>> 27/03/2020 10:49

Engineering Log - Borehole

client: **EMM CONSULTING PTY LTD**
principal: **Evolution Mining**
project: **CGO UNDERGROUND DEVELOPMENT EIS**
location: **COWAL GOLD OPERATIONS**

Borehole ID: **UG-BH-02**
sheet: 3 of 13
project no. **754-SYDGE206418-3**
date started: **02 Feb 2020**
date completed: **06 Feb 2020**
logged by: **TBM**
checked by: **PLV**

position: Not Specified surface elevation: Not Specified angle from horizontal: -90°
drill model: Sandvik DE840, Truck mounted drilling fluid: PAK-R casing diameter: PVC150/PW

drilling information				material substance									
method & support	penetration	water	samples & field tests	RL (m)	depth (m)	graphic log	soil group symbol	material description	moisture condition	consistency / relative density	hand penetrometer (kPa)	structure and additional observations	
					17.0			Sandy CLAY: high plasticity, red/brown mottled pale grey, sand is fine to coarse grained, with fine to coarse grained, sub-rounded to sub-angular gravel. (continued)				LACUSTRINE	
					18.0			CORE LOSS 3.8M.					Core Run (17.8-18.9 m): 0% recovery
					19.0							Core Run (18.9-21.2 m): 30% recovery	
					20.0								
					21.0			CLAYEY SAND: fine to coarse grained, pale grey mottled pale brown, clay is high plasticity, with fine to coarse grained, sub-rounded gravel and bands of highly weathered, very low strength sandstone up to 40mm thick.				RESIDUAL SOIL	
					22.0			CORE LOSS 2.0M.					Core Run (21.2-22.1 m): 0% recovery
					23.0								Core Run (22.1-22.7 m): 0% recovery
					23.5			CLAYEY SAND: fine to coarse grained, pale grey mottled pale brown, clay is high plasticity, with fine to coarse grained, sub-rounded gravel.				Core Run (22.7-23.5 m): 63% recovery	
					24.0			CORE LOSS 0.4M.				Core Run (23.5-24.6 m): 64% recovery	

method AD auger drilling* AS auger screwing* HA hand auger W washbore * bit shown by suffix e.g. AD/T B blank bit T TC bit V V bit	support M mud C casing N nil penetration no resistance ranging to refusal water 10-Oct-12 water level on date shown water inflow water outflow	samples & field tests B bulk disturbed sample D disturbed sample E environmental sample SS split spoon sample U## undisturbed sample ##mm diameter HP hand penetrometer (kPa) N standard penetration test (SPT) N* SPT - sample recovered Nc SPT with solid cone VS vane shear, peak/remoulded (kPa) R refusal HB hammer bouncing	soil group symbol & soil description based on AS 1726:2017 moisture condition D dry M moist W wet Wp plastic limit WI liquid limit	consistency / relative density VS very soft S soft F firm St stiff VSt very stiff H hard Fb friable VL very loose L loose MD medium dense D dense VD very dense
---	--	--	---	--

CDF_0_9_07_LIBRARY.GLB rev:AU Log COF BOREHOLE: NON CORED 754-SYDGE206418-3.GPJ <<DrawingFile>> 27/03/2020 10:49

Engineering Log - Borehole

client: **EMM CONSULTING PTY LTD**
principal: **Evolution Mining**
project: **CGO UNDERGROUND DEVELOPMENT EIS**
location: **COWAL GOLD OPERATIONS**

Borehole ID: **UG-BH-02**
sheet: 4 of 13
project no: **754-SYDGE206418-3**
date started: **02 Feb 2020**
date completed: **06 Feb 2020**
logged by: **TBM**
checked by: **PLV**

position: Not Specified surface elevation: Not Specified angle from horizontal: -90°
drill model: Sandvik DE840, Truck mounted drilling fluid: PAK-R casing diameter: PVC150/PW

drilling information				material substance								
method & support	penetration	water	samples & field tests	RL (m)	depth (m)	graphic log	soil group symbol	material description	moisture condition	consistency / relative density	hand penetrometer (kPa)	structure and additional observations
AD	1				25.0			Sandy CLAY: high plasticity, mottled pale brown/orange and pale grey, sand is fine to coarse grained, with fine to coarse grained, sub-rounded to sub-angular gravel and bands of highly weathered, very low strength sandstone up to 30mm thick. (continued) CORE LOSS 0.9M.				RESIDUAL SOIL Core Run (24.6-25.7 m): 18% recovery
					26.0			Sandy CLAY: high plasticity, mottled pale brown/orange and pale grey, sand is fine to coarse grained, with fine to coarse grained, sub-rounded to sub-angular gravel. CORE LOSS 2.0M.				Core Run (25.7-26.6 m): 0% recovery Core Run (26.6-26.7 m): 0% recovery Core Run (26.7-26.9 m): 0% recovery Core Run (26.9-27.2 m): 0% recovery Core Run (27.2-27.3 m): 0% recovery Core Run (27.3-27.7 m): 0% recovery
					28.0			Sandy CLAY: high plasticity, mottled pale brown/orange and pale grey, sand is fine to coarse grained, with fine to coarse grained, sub-rounded to sub-angular gravel. CORE LOSS 0.4M.				Core Run (27.7-27.8 m): 100% recovery Core Run (27.8-28.0 m): 50% recovery Core Run (28.0-29.1 m): 64% recovery
					29.0			Sandy CLAY: high plasticity, mottled pale brown/orange and pale grey, sand is fine to coarse grained, with fine to coarse grained, sub-rounded to gravel found in irregular bands up to 100mm thick showing signs of iron oxide staining, and bands of highly weathered, very low strength sandstone up to 30mm thick.				Core Run (29.1-30.2 m): 100% recovery Core Run (30.2-31.2 m): 100% recovery Core Run (31.2-31.7 m): 0% recovery Core Run (31.7-33.2 m): 100% recovery

method AD auger drilling* AS auger screwing* HA hand auger W washbore * bit shown by suffix e.g. AD/T B blank bit T TC bit V V bit	support M mud C casing penetration water 	samples & field tests B bulk disturbed sample D disturbed sample E environmental sample SS split spoon sample U## undisturbed sample ##mm diameter HP hand penetrometer (kPa) N standard penetration test (SPT) N* SPT - sample recovered Nc SPT with solid cone VS vane shear, peak/remoulded (kPa) R refusal HB hammer bouncing	soil symbol & soil description based on AS 1726:2017 moisture condition D dry M moist W wet Wp plastic limit WI liquid limit	consistency / relative density VS very soft S soft F firm St stiff VSt very stiff H hard Fb friable VL very loose L loose MD medium dense D dense VD very dense
--	---	--	---	--

CDF_0_9_07_LIBRARY.GLB rev:AU Log COF BOREHOLE: NON CORED 754-SYDGE206418-3.GPJ <<DrawingFile>> 27/03/2020 10:49

Engineering Log - Borehole

DRAFT

client: **EMM CONSULTING PTY LTD**
principal: **Evolution Mining**
project: **CGO UNDERGROUND DEVELOPMENT EIS**
location: **COWAL GOLD OPERATIONS**

Borehole ID: **UG-BH-02**
sheet: 5 of 13
project no. **754-SYDGE206418-3**
date started: **02 Feb 2020**
date completed: **06 Feb 2020**
logged by: **TBM**
checked by: **PLV**

position: Not Specified surface elevation: Not Specified angle from horizontal: -90°
drill model: Sandvik DE840, Truck mounted drilling fluid: PAK-R casing diameter: PVC150/PW

drilling information				material substance								
method & support	penetration	water	samples & field tests	RL (m)	depth (m)	graphic log	soil group symbol	material description	moisture condition	consistency / relative density	hand penetrometer (kPa)	structure and additional observations
HQ PW casing Not Observable					33.0 34.0 35.0 36.0 37.0 38.0 39.0			Sandy CLAY: high plasticity, mottled pale brown/orange and pale grey, sand is fine to coarse grained, with fine to coarse grained, sub-rounded to gravel found in irregular bands up to 100mm thick showing signs of iron oxide staining, and bands of highly weathered, very low strength sandstone up to 30mm thick. <i>(continued)</i> 33.0 m: bands of higher sand content appearing up to 80mm thick 33.1 m: becoming red/brown mottled plae grey, with signs of iron oxide cementation appearing 35.7 m: becoming red/brown mottled pale brown 38.5 m: becoming mottled red/brown, pale grey and pale brown				RESIDUAL SOIL Core Run (33.2-33.8 m): 50% recovery Core Run (33.8-34.5 m): 100% recovery Core Run (34.5-36.1 m): 100% recovery Core Run (36.1-39.1 m): 100% recovery Core Run (39.1-42.0 m): 100% recovery

method AD auger drilling* AS auger screwing* HA hand auger W washbore * bit shown by suffix e.g. AD/T B blank bit T TC bit V V bit	support M mud N nil C casing penetration no resistance ranging to refusal water 10-Oct-12 water level on date shown water inflow water outflow	samples & field tests B bulk disturbed sample D disturbed sample E environmental sample SS split spoon sample U## undisturbed sample ##mm diameter HP hand penetrometer (kPa) N standard penetration test (SPT) N* SPT - sample recovered Nc SPT with solid cone VS vane shear, peak/remoulded (kPa) R refusal HB hammer bouncing	soil group symbol & soil description based on AS 1726:2017 moisture condition D dry M moist W wet Wp plastic limit WI liquid limit	consistency / relative density VS very soft S soft F firm St stiff VSt very stiff H hard Fb friable VL very loose L loose MD medium dense D dense VD very dense
--	--	--	---	--

CDF_0_9_07_LIBRARY.GLB rev:AU Log COF BOREHOLE: NON CORED 754-SYDGE206418-3.GPJ <<DrawingFile>> 27/03/2020 10:49

Engineering Log - Borehole

DRAFT

client: **EMM CONSULTING PTY LTD**
principal: **Evolution Mining**
project: **CGO UNDERGROUND DEVELOPMENT EIS**
location: **COWAL GOLD OPERATIONS**

Borehole ID: **UG-BH-02**
sheet: 6 of 13
project no. **754-SYDGE206418-3**
date started: **02 Feb 2020**
date completed: **06 Feb 2020**
logged by: **TBM**
checked by: **PLV**

position: Not Specified surface elevation: Not Specified angle from horizontal: -90°
drill model: Sandvik DE840, Truck mounted drilling fluid: PAK-R casing diameter: PVC150/PW

drilling information				material substance								
method & support	penetration	water	samples & field tests	RL (m)	depth (m)	graphic log	soil group symbol	material description	moisture condition	consistency / relative density	hand penetrometer (kPa)	structure and additional observations
HQ PW casing		Not Observable			41.0 42.0 43.0 44.0 45.0 46.0 47.0			Sandy CLAY: high plasticity, mottled pale brown/orange and pale grey, sand is fine to coarse grained, with fine to coarse grained, sub-rounded to gravel found in irregular bands up to 100mm thick showing signs of iron oxide staining, and bands of highly weathered, very low strength sandstone up to 30mm thick. <i>(continued)</i> 45.1 m: signs of manganese staining appearing around joints 46.0 m: indistinct bedding at approx. 70°			100 200 300 400	RESIDUAL SOIL Core Run (42.0-45.1 m): 100% recovery EXTREMELY WEATHERED ROCK Core Run (45.1-48.1 m): 100% recovery

method AD auger drilling* AS auger screwing* HA hand auger W washbore * bit shown by suffix e.g. AD/T B blank bit T TC bit V V bit	support M mud N nil C casing penetration no resistance ranging to refusal water 10-Oct-12 water level on date shown water inflow water outflow	samples & field tests B bulk disturbed sample D disturbed sample E environmental sample SS split spoon sample U## undisturbed sample ##mm diameter HP hand penetrometer (kPa) N standard penetration test (SPT) N* SPT - sample recovered Nc SPT with solid cone VS vane shear; peak/remoulded (kPa) R refusal HB hammer bouncing	soil group symbol & soil description based on AS 1726:2017 moisture condition D dry M moist W wet Wp plastic limit WI liquid limit	consistency / relative density VS very soft S soft F firm St stiff VSt very stiff H hard Fb friable VL very loose L loose MD medium dense D dense VD very dense
--	--	--	---	--

Engineering Log - Borehole

DRAFT

client: **EMM CONSULTING PTY LTD**
principal: **Evolution Mining**
project: **CGO UNDERGROUND DEVELOPMENT EIS**
location: **COWAL GOLD OPERATIONS**

Borehole ID: **UG-BH-02**
sheet: 7 of 13
project no. **754-SYDGE206418-3**
date started: **02 Feb 2020**
date completed: **06 Feb 2020**
logged by: **TBM**
checked by: **PLV**

position: Not Specified surface elevation: Not Specified angle from horizontal: -90°
drill model: Sandvik DE840, Truck mounted drilling fluid: PAK-R casing diameter: PVC150/PW

drilling information				material substance								
method & support	penetration	water	samples & field tests	RL (m)	depth (m)	graphic log	soil group symbol	material description	moisture condition	consistency / relative density	hand penetrometer (kPa)	structure and additional observations
HQ PW casing Not Observable					49.0 50.0 51.0 52.0 53.0 54.0 55.0			Sandy CLAY: high plasticity, mottled pale brown/orange and pale grey, sand is fine to coarse grained, with fine to coarse grained, sub-rounded to gravel found in irregular bands up to 100mm thick showing signs of iron oxide staining, and bands of highly weathered, very low strength sandstone up to 30mm thick. <i>(continued)</i> 48.3 m: bands of sandstone no longer visible, sections resemble highly weathered chert or metamorphised mudstone 48.3 to 53.5 m: rock is pale grey to pale brown 53.5 m: becoming red/brown mottled pale grey and pale brown				EXTREMELY WEATHERED ROCK Core Run (48.1-51.2 m): 100% recovery Core Run (51.2-54.1 m): 100% recovery Core Run (54.1-57.2 m): 61% recovery
CORE LOSS 1.2M.												
Borehole UG-BH-02 continued as cored hole												

CDF_0_9_07_LIBRARY.GLB rev:AU Log COF BOREHOLE: NON CORED 754-SYDGE206418-3.GPJ <<DrawingFile>> 27/03/2020 10:49

method AD auger drilling* AS auger screwing* HA hand auger W washbore * bit shown by suffix e.g. AD/T B blank bit T TC bit V V bit	support M mud N nil C casing penetration water 10-Oct-12 water level on date shown water inflow water outflow	samples & field tests B bulk disturbed sample D disturbed sample E environmental sample SS split spoon sample U## undisturbed sample ##mm diameter HP hand penetrometer (kPa) N standard penetration test (SPT) N* SPT - sample recovered Nc SPT with solid cone VS vane shear; peak/remoulded (kPa) R refusal HB hammer bouncing	soil group symbol & soil description based on AS 1726:2017 moisture condition D dry M moist W wet Wp plastic limit WI liquid limit	consistency / relative density VS very soft S soft F firm St stiff VSt very stiff H hard Fb friable VL very loose L loose MD medium dense D dense VD very dense
--	--	--	---	--

Engineering Log - Cored Borehole

Borehole ID: **UG-BH-02**
 sheet: 8 of 14
 project no: **754-SYDGE206418-3**
 date started: **02 Feb 2020**
 date completed: **06 Feb 2020**
 logged by: **TBM**
 checked by: **PLV**

client: **EMM CONSULTING PTY LTD**
 principal: **Evolution Mining**
 project: **CGO UNDERGROUND DEVELOPMENT EIS**
 location: **COWAL GOLD OPERATIONS**

position: Not Specified surface elevation: Not Specified angle from horizontal: -90°
 drill model: Sandvik DE840, Truck mounted drilling fluid: PAK-R casing diameter: PVC150/PW

drilling information		material substance				rock mass defects				
method & support	water	RL (m)	depth (m)	graphic log	material description ROCK TYPE: grain characteristics, colour, structure, minor components	weathering & alteration	estimated strength & Is50 X = axial O = diametral a = axial d = diametral	samples, field tests & Is(50) (MPa)	defect spacing (mm)	additional observations and defect descriptions (type, inclination, planarity, roughness, coating, thickness, other)
			49.0							
			50.0							
			51.0							
			52.0							
			53.0							
			54.0							
			55.0							
					started coring at 55.60m					
					MUDSTONE: red/brown/grey, distinctly bedded at 25-50°, with clay seams up to 2mm thick.	XW - HW				

<p>method & support</p> <p>AS auger screwing AD auger drilling CB claw or blade bit W washbore RR rock roller NMLCNMLC core (51.9 mm) NQ wireline core (47.6mm) HQ wireline core (63.5mm) PQ wireline core (85.0mm)</p>	<p>support</p> <p>C casing M mud N none</p> <p>water</p> <p>10/10/12, water level on date shown water inflow complete drilling fluid loss partial drilling fluid loss</p> <p>water pressure test result (lugeons) for depth interval shown</p>	<p>graphic log / core recovery</p> <p>core recovered (graphic symbols indicate material) no core recovered</p> <p>core run & RQD</p> <p>barrel withdrawn</p> <p>RQD = Rock Quality Designation (%)</p>	<p>weathering & alteration*</p> <p>RS residual soil XW extremely weathered HW highly weathered MW moderately weathered SW slightly weathered FR fresh *W replaced with A for alteration</p> <p>strength</p> <p>VL very low L low M medium H high VH very high EH extremely high</p>	<p>defect type</p> <p>PT parting JT joint SS shear surface SZ shear zone CO contact CS crushed seam SM seam</p> <p>roughness</p> <p>VR very rough RO rough SO smooth POL polished SL slickensided</p>	<p>planarity</p> <p>PL planar CU curved UN undulating ST stepped IR irregular</p> <p>coating</p> <p>CN clean SN stained VN veneer CO coating</p>
--	---	---	--	---	---

CDF_0_9_07_LIBRARY.GLB rev:AU Log COF BOREHOLE: CORED 754-SYDGE206418-3.GPJ <<DrawingFile>> 27/03/2020 10:52



Engineering Log - Cored Borehole

client: **EMM CONSULTING PTY LTD**
principal: **Evolution Mining**
project: **CGO UNDERGROUND DEVELOPMENT EIS**
location: **COWAL GOLD OPERATIONS**

Borehole ID: **UG-BH-02**
sheet: 9 of 14
project no: **754-SYDGE206418-3**
date started: **02 Feb 2020**
date completed: **06 Feb 2020**
logged by: **TBM**
checked by: **PLV**

position: Not Specified surface elevation: Not Specified angle from horizontal: -90°
drill model: Sandvik DE840, Truck mounted drilling fluid: PAK-R casing diameter: PVC150/PW

drilling information		material substance				rock mass defects						
method & support	water	RL (m)	depth (m)	graphic log	material description ROCK TYPE: grain characteristics, colour, structure, minor components	weathering & alteration	estimated strength & Is(50) X = axial O = diametral a = axial d = diametral	samples, field tests & Is(50) (MPa)	core run & RQD	defect spacing (mm)	additional observations and defect descriptions (type, inclination, planarity, roughness, coating, thickness, other)	
											particular	general
			57.0		MUDSTONE: red/brown/grey, distinctly bedded at 25-50°, with clay seams up to 2mm thick. (continued)	XW - HW					SM, 25°, Clay, 130 mm	
			58.0		CORE LOSS 0.5M.						SM, 25°, Clay, 90 mm	
			59.0		MUDSTONE: brown/grey, distinctly bedded at 25-50°, with clay seams up to 2mm thick.	XW - HW					SM, 20°, Clay, 100 mm	
			60.0		CORE LOSS 0.4M.							
			61.0		MUDSTONE: brown/grey, distinctly bedded at 25-50°, with clay seams up to 2mm thick.	XW - HW						
			62.0		MUDSTONE: brown/grey, distinctly bedded at 25-50°, with clay seams up to 2mm thick.	XW						
			62.40		62.40 m: becoming purple/brown, clay seams not longer visible							
			63.0		CORE LOSS 0.6M.							
					MUDSTONE: purple/brown, distinctly bedded at 25-50°.	XW - HW						

method & support AS auger screwing AD auger drilling CB claw or blade bit W washbore RR rock roller NMLCNMLC core (51.9 mm) NQ wireline core (47.6mm) HQ wireline core (63.5mm) PQ wireline core (85.0mm)	support C casing M mud N none water 10/10/12, water level on date shown water inflow complete drilling fluid loss partial drilling fluid loss water pressure test result (lugeons) for depth interval shown	graphic log / core recovery core recovered (graphic symbols indicate material) no core recovered core run & RQD barrel withdrawn RQD = Rock Quality Designation (%)	weathering & alteration* RS residual soil XW extremely weathered HW highly weathered MW moderately weathered SW slightly weathered FR fresh *W replaced with A for alteration strength VL very low L low M medium H high VH very high EH extremely high	defect type PT parting JT joint SS shear surface SZ shear zone CO contact CS crushed seam SM seam roughness VR very rough RO rough SO smooth POL polished SL slickensided	planarity PL planar CU curved UN undulating ST stepped IR irregular coating CN clean SN stained VN veneer CO coating
---	--	--	---	--	--









Engineering Log - Cored Borehole

Borehole ID: **UG-BH-02**
 sheet: 10 of 14
 project no: **754-SYDGE206418-3**
 date started: **02 Feb 2020**
 date completed: **06 Feb 2020**
 logged by: **TBM**
 checked by: **PLV**

client: **EMM CONSULTING PTY LTD**
 principal: **Evolution Mining**
 project: **CGO UNDERGROUND DEVELOPMENT EIS**
 location: **COWAL GOLD OPERATIONS**

position: Not Specified surface elevation: Not Specified angle from horizontal: -90°
 drill model: Sandvik DE840, Truck mounted drilling fluid: PAK-R casing diameter: PVC150/PW

drilling information		material substance				rock mass defects						
method & support	water	RL (m)	depth (m)	graphic log	material description ROCK TYPE: grain characteristics, colour, structure, minor components	weathering & alteration	estimated strength & Is50 X = axial O = diametral a = axial d = diametral	samples, field tests & Is(50) (MPa)	core run & RQD	defect spacing (mm)	additional observations and defect descriptions (type, inclination, planarity, roughness, coating, thickness, other)	
											particular	general
			65.0		CORE LOSS 1.9M.	XW - HW						
			66.0									
			67.0		MUDSTONE: purple/brown, indistinctly bedded 60-80°.	HW						
			68.0		CORE LOSS 1.0M.							
			69.0									
			70.0		MUDSTONE: purple/brown, indistinctly bedded 60-80°.	HW - XW						
			71.0		CORE LOSS 0.5M.							
			71.30		MUDSTONE: purple/brown, indistinctly bedded 60-80°. 71.30 m: becoming red/brown	HW - XW						

method & support AS auger screwing AD auger drilling CB claw or blade bit W washbore RR rock roller NMLCNMLC core (51.9 mm) NQ wireline core (47.6mm) HQ wireline core (63.5mm) PQ wireline core (85.0mm)	support C casing M mud N none water  10/10/12, water level on date shown  water inflow  complete drilling fluid loss  partial drilling fluid loss  water pressure test result (lugeons) for depth interval shown	graphic log / core recovery  core recovered (graphic symbols indicate material)  no core recovered core run & RQD  barrel withdrawn RQD = Rock Quality Designation (%)	weathering & alteration* RS residual soil XW extremely weathered HW highly weathered MW moderately weathered SW slightly weathered FR fresh *W replaced with A for alteration strength VL very low L low M medium H high VH very high EH extremely high	defect type PT parting JT joint SS shear surface SZ shear zone CO contact CS crushed seam SM seam roughness VR very rough RO rough SO smooth POL polished SL slickensided	planarity PL planar CU curved UN undulating ST stepped IR irregular coating CN clean SN stained VN veneer CO coating
---	--	--	---	--	--

Engineering Log - Cored Borehole

Borehole ID. **UG-BH-02**
 sheet: 11 of 14
 project no. **754-SYDGE206418-3**
 date started: **02 Feb 2020**
 date completed: **06 Feb 2020**
 logged by: **TBM**
 checked by: **PLV**

client: **EMM CONSULTING PTY LTD**
 principal: **Evolution Mining**
 project: **CGO UNDERGROUND DEVELOPMENT EIS**
 location: **COWAL GOLD OPERATIONS**

position: Not Specified surface elevation: Not Specified angle from horizontal: -90°
 drill model: Sandvik DE840, Truck mounted drilling fluid: PAK-R casing diameter: PVC150/PW

drilling information		material substance				rock mass defects					
method & support	water	RL (m)	depth (m)	graphic log	material description ROCK TYPE: grain characteristics, colour, structure, minor components	weathering & alteration	estimated strength & Is(50) X = axial O = diametral a = axial d = diametral	samples, field tests & Is(50) (MPa)	core run & RQD	defect spacing (mm)	additional observations and defect descriptions (type, inclination, planarity, roughness, coating, thickness, other)
										30 100 300 1000 3000	particular general
					CORE LOSS 0.7M.						
			73.0		MUDSTONE: red/brown, indistinctly bedded 60-80°.	XW - HW					
			74.0								
			75.0		CORE LOSS 0.4M.						
			76.0		MUDSTONE: red/brown, indistinctly bedded 60-80°.	XW - HW					
			77.0								
			78.0		CORE LOSS 0.2M.						
			78.4		MUDSTONE: red/brown/grey, indistinct bedding.	XW - HW					
			79.0		78.40 m: becoming purple/brown						
					CORE LOSS 0.4M.						
					MUDSTONE: purple/brown/grey, indistinct bedding.	XW - HW					

method & support AS auger screwing AD auger drilling CB claw or blade bit W washbore RR rock roller NMLCNMLC core (51.9 mm) NQ wireline core (47.6mm) HQ wireline core (63.5mm) PQ wireline core (85.0mm)	support C casing M mud N none water 10/10/12, water level on date shown water inflow complete drilling fluid loss partial drilling fluid loss water pressure test result (lugeons) for depth interval shown	graphic log / core recovery core recovered (graphic symbols indicate material) no core recovered core run & RQD barrel withdrawn RQD = Rock Quality Designation (%)	weathering & alteration* RS residual soil XW extremely weathered HW highly weathered MW moderately weathered SW slightly weathered FR fresh *W replaced with A for alteration strength VL very low L low M medium H high VH very high EH extremely high	defect type PT parting JT joint SS shear surface SZ shear zone CO contact CS crushed seam SM seam roughness VR very rough RO rough SO smooth POL polished SL slickensided	planarity PL planar CU curved UN undulating ST stepped IR irregular coating CN clean SN stained VN veneer CO coating
---	--	--	---	--	--

CDF_0_9_07_LIBRARY.GLB rev:AU Log COF BOREHOLE: CORED 754-SYDGE206418-3.GPJ <<DrawingFile>> 27/03/2020 10:52











Engineering Log - Cored Borehole

Borehole ID. **UG-BH-02**
 sheet: 12 of 14
 project no. **754-SYDGE206418-3**
 date started: **02 Feb 2020**
 date completed: **06 Feb 2020**
 logged by: **TBM**
 checked by: **PLV**

client: **EMM CONSULTING PTY LTD**
 principal: **Evolution Mining**
 project: **CGO UNDERGROUND DEVELOPMENT EIS**
 location: **COWAL GOLD OPERATIONS**

position: Not Specified surface elevation: Not Specified angle from horizontal: -90°
 drill model: Sandvik DE840, Truck mounted drilling fluid: PAK-R casing diameter: PVC150/PW

drilling information		material substance				rock mass defects						
method & support	water	RL (m)	depth (m)	graphic log	material description ROCK TYPE: grain characteristics, colour, structure, minor components	weathering & alteration	estimated strength & Is50 X = axial O = diametral a = axial d = diametral	samples, field tests & Is(50) (MPa)	core run & RQD	defect spacing (mm)	additional observations and defect descriptions (type, inclination, planarity, roughness, coating, thickness, other)	
							VL L M H VH EH			30 100 300 1000 3000	particular	general
					MUDSTONE: purple/brown/grey, indistinct bedding. (continued)	XW - HW						
					CORE LOSS 0.3M.							
			81.0		MUDSTONE: purple/brown, indistinctly bedded 60-80°.	XW - HW					JT, 50°, PL, SO, Sandy clay CO	
			82.0									
			83.0									
			84.0									
			85.0			HW						
			86.0									
			87.0		CORE LOSS 0.6M.							
					MUDSTONE: purple/brown, indistinctly bedded 60-80°.	XW - HW						JT, 40°, PL, SO, Fe SN

method & support AS auger screwing AD auger drilling CB claw or blade bit W washbore RR rock roller NMLCNMLC core (51.9 mm) NQ wireline core (47.6mm) HQ wireline core (63.5mm) PQ wireline core (85.0mm)	support C casing M mud N none water  10/10/12, water level on date shown  water inflow  complete drilling fluid loss  partial drilling fluid loss  water pressure test result (lugeons) for depth interval shown	graphic log / core recovery  core recovered (graphic symbols indicate material)  no core recovered core run & RQD  barrel withdrawn RQD = Rock Quality Designation (%)	weathering & alteration* RS residual soil XW extremely weathered HW highly weathered MW moderately weathered SW slightly weathered FR fresh *W replaced with A for alteration strength VL very low L low M medium H high VH very high EH extremely high	defect type PT parting JT joint SS shear surface SZ shear zone CO contact CS crushed seam SM seam roughness VR very rough RO rough SO smooth POL polished SL slickensided	planarity PL planar CU curved UN undulating ST stepped IR irregular coating CN clean SN stained VN veneer CO coating
---	--	--	---	--	--

Engineering Log - Cored Borehole

Borehole ID. **UG-BH-02**
 sheet: 13 of 14
 project no. **754-SYDGE206418-3**
 date started: **02 Feb 2020**
 date completed: **06 Feb 2020**
 logged by: **TBM**
 checked by: **PLV**

client: **EMM CONSULTING PTY LTD**
 principal: **Evolution Mining**
 project: **CGO UNDERGROUND DEVELOPMENT EIS**
 location: **COWAL GOLD OPERATIONS**

position: Not Specified surface elevation: Not Specified angle from horizontal: -90°
 drill model: Sandvik DE840, Truck mounted drilling fluid: PAK-R casing diameter: PVC150/PW

drilling information		material substance				rock mass defects					
method & support	water	RL (m)	depth (m)	graphic log	material description ROCK TYPE: grain characteristics, colour, structure, minor components	weathering & alteration	estimated strength & Is(50) X = axial O = diametral a = axial d = diametral	samples, field tests & Is(50) (MPa)	core run & RQD	defect spacing (mm)	additional observations and defect descriptions (type, inclination, planarity, roughness, coating, thickness, other)
							VL L M H VH EH			30 100 300 1000 3000	particular general
			89.0		MUDSTONE: purple/brown, indistinctly bedded 60-80°. (continued)						JT, 70°, PL, SO, Fe SN JT, 70°, PL, SO, Fe SN JT, 50°, PL, SO, Fe SN
			90.0		89.60 m: becoming pale brown, indistinctly bedded at 35-55° 90.10 to 90.80 m: trace of manganese staining around joints	HW - XW					JT, 70°, PL, SO, Fe SN
			91.0		CORE LOSS 2.3M.						
			92.0								
			93.0								
			94.0		MUDSTONE: pale brown, indistinctly bedded 35-55°, minor bands of 'silicified' mudstone.	HW - XW					
			95.0			HW					

method & support AS auger screwing AD auger drilling CB claw or blade bit W washbore RR rock roller NMLCNMLC core (51.9 mm) NQ wireline core (47.6mm) HQ wireline core (63.5mm) PQ wireline core (85.0mm)	support C casing M mud N none water 10/10/12, water level on date shown water inflow complete drilling fluid loss partial drilling fluid loss water pressure test result (lugeons) for depth interval shown	graphic log / core recovery core recovered (graphic symbols indicate material) no core recovered core run & RQD barrel withdrawn RQD = Rock Quality Designation (%)	weathering & alteration* RS residual soil XW extremely weathered HW highly weathered MW moderately weathered SW slightly weathered FR fresh *W replaced with A for alteration strength VL very low L low M medium H high VH very high EH extremely high	defect type PT parting JT joint SS shear surface SZ shear zone CO contact CS crushed seam SM seam roughness VR very rough RO rough SO smooth POL polished SL slickensided	planarity PL planar CU curved UN undulating ST stepped IR irregular coating CN clean SN stained VN veneer CO coating
---	--	--	---	--	--

Engineering Log - Cored Borehole

Borehole ID. **UG-BH-02**
 sheet: 14 of 14
 project no. **754-SYDGE206418-3**
 date started: **02 Feb 2020**
 date completed: **06 Feb 2020**
 logged by: **TBM**
 checked by: **PLV**

client: **EMM CONSULTING PTY LTD**
 principal: **Evolution Mining**
 project: **CGO UNDERGROUND DEVELOPMENT EIS**
 location: **COWAL GOLD OPERATIONS**

position: Not Specified surface elevation: Not Specified angle from horizontal: -90°
 drill model: Sandvik DE840, Truck mounted drilling fluid: PAK-R casing diameter: PVC150/PW

drilling information		material substance				rock mass defects						
method & support	water	RL (m)	depth (m)	graphic log	material description ROCK TYPE: grain characteristics, colour, structure, minor components	weathering & alteration	estimated strength & Is(50) X = axial O = diametral a = axial d = diametral	samples, field tests & Is(50) (MPa)	core run & RQD	defect spacing (mm)	additional observations and defect descriptions (type, inclination, planarity, roughness, coating, thickness, other)	
											particular	general
			97.0		MUDSTONE: pale brown, indistinctly bedded 35-55°, minor bands of 'silicified' mudstone. (continued)	HW - XW						
			98.0									
			99.0			HW						
			100.0		99.90 m: becoming grey/purple/brown, distinctly bedded at 20-35°	MW - SW						
			101.0		CORE LOSS 0.4M.							
			102.0		MUDSTONE: grey/purple/brown, distinctly bedded 20-35°.	MW - SW						
			103.0		Borehole UG-BH-02 terminated at 102.80 m Target depth							

CDF_0_9_07_LIBRARY.GLB rev:AU Log COF BOREHOLE: CORED 754-SYDGE206418-3.GPJ <<DrawingFile>> 27/03/2020 10:52

method & support AS auger screwing AD auger drilling CB claw or blade bit W washbore RR rock roller NMLCNMLC core (51.9 mm) NQ wireline core (47.6mm) HQ wireline core (63.5mm) PQ wireline core (85.0mm)	support C casing M mud N none water 10/10/12, water level on date shown water inflow complete drilling fluid loss partial drilling fluid loss water pressure test result (lugeons) for depth interval shown	graphic log / core recovery core recovered (graphic symbols indicate material) no core recovered core run & RQD barrel withdrawn RQD = Rock Quality Designation (%)	weathering & alteration* RS residual soil XW extremely weathered HW highly weathered MW moderately weathered SW slightly weathered FR fresh *W replaced with A for alteration strength VL very low L low M medium H high VH very high EH extremely high	defect type PT parting JT joint SS shear surface SZ shear zone CO contact CS crushed seam SM seam roughness VR very rough RO rough SO smooth POL polished SL slickensided	planarity PL planar CU curved UN undulating ST stepped IR irregular coating CN clean SN stained VN veneer CO coating
---	--	--	---	--	--



UG-BH-02 5.80 - 9.10 m

drawn	TBM		client:	EMM CONSULTING PTY LTD		
approved	AO		project:	CGO UNDERGROUND DEVELOPMENT EIS COWAL GOLD OPERATIONS		
date	23/03/2020		title:	CORE PHOTOGRAPH UG-BH-02		
scale	N.T.S.		project no:	754-SYDGE206418-3	fig no:	FIGURE 1
original size	A4		rev:	A		



UG-BH-02 9.10 - 13.00 m

drawn	TBM		client:	EMM CONSULTING PTY LTD		
approved	AO		project:	CGO UNDERGROUND DEVELOPMENT EIS COWAL GOLD OPERATIONS		
date	23/03/2020		title:	CORE PHOTOGRAPH UG-BH-02		
scale	N.T.S.		project no:	754-SYDGE206418-3	fig no:	FIGURE 2
original size	A4		rev:	A		



UG-BH-02 13.00 - 18.90 m

drawn	TBM		client:	EMM CONSULTING PTY LTD		
approved	AO		project:	CGO UNDERGROUND DEVELOPMENT EIS COWAL GOLD OPERATIONS		
date	23/03/2020		title:	CORE PHOTOGRAPH UG-BH-02		
scale	N.T.S.		project no:	754-SYDGE206418-3	fig no:	FIGURE 3
original size	A4				rev:	A



UG-BH-02 18.90 - 29.30 m

drawn	TBM	 A TETRA TECH COMPANY	client:	EMM CONSULTING PTY LTD				
approved	AO		project:	CGO UNDERGROUND DEVELOPMENT EIS COWAL GOLD OPERATIONS				
date	23/03/2020		title:	CORE PHOTOGRAPH UG-BH-02				
scale	N.T.S.		project no:	754-SYDGE206418-3	fig no:	FIGURE 4	rev:	A
original size	A4							



UG-BH-02 29.30 - 32.90 m

drawn	TBM		client:	EMM CONSULTING PTY LTD		
approved	AO		project:	CGO UNDERGROUND DEVELOPMENT EIS COWAL GOLD OPERATIONS		
date	23/03/2020		title:	CORE PHOTOGRAPH UG-BH-02		
scale	N.T.S.		project no:	754-SYDGE206418-3	fig no:	FIGURE 5
original size	A4		rev:	A		

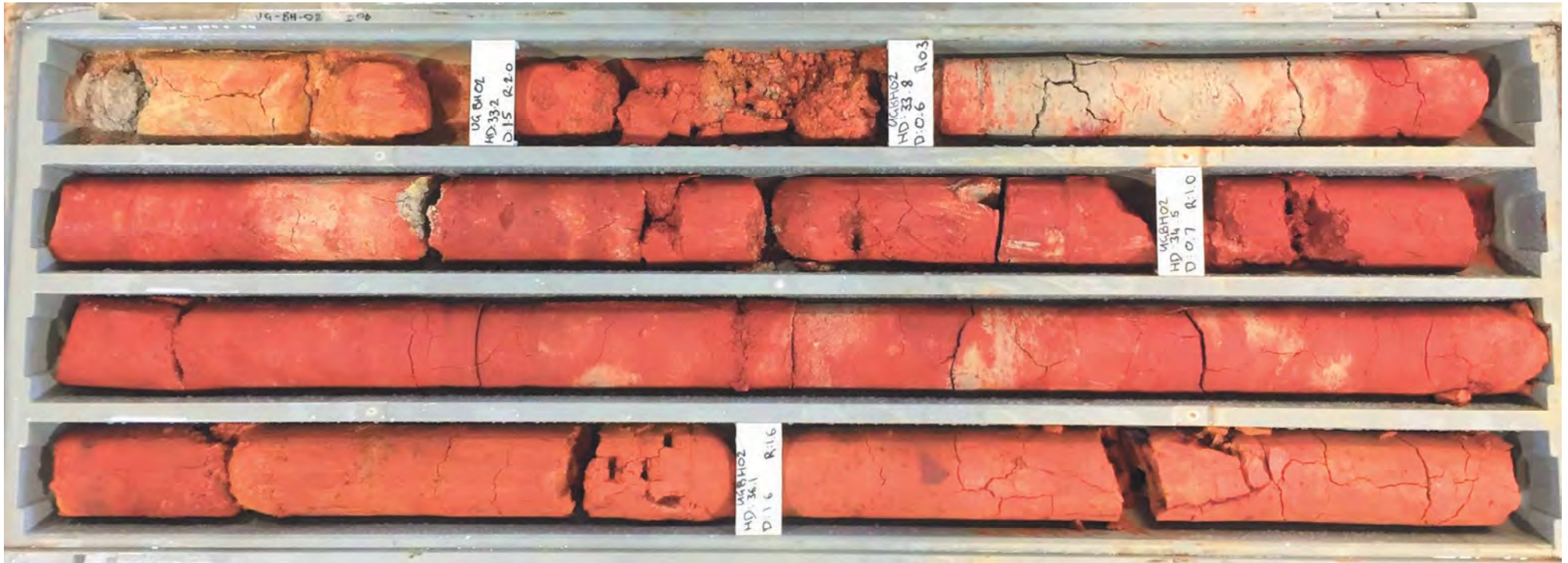

UG-BH-02 32.90 - 36.60 m

drawn	TBM		client:	EMM CONSULTING PTY LTD		
approved	AO		project:	CGO UNDERGROUND DEVELOPMENT EIS COWAL GOLD OPERATIONS		
date	23/03/2020		title:	CORE PHOTOGRAPH UG-BH-02		
scale	N.T.S.		project no:	754-SYDGE206418-3	fig no:	FIGURE 6
original size	A4				rev:	A



UG-BH-02 36.60 - 40.20 m

drawn	TBM		client:	EMM CONSULTING PTY LTD		
approved	AO		project:	CGO UNDERGROUND DEVELOPMENT EIS COWAL GOLD OPERATIONS		
date	23/03/2020		title:	CORE PHOTOGRAPH UG-BH-02		
scale	N.T.S.		project no:	754-SYDGE206418-3	fig no:	FIGURE 7
original size	A4		rev:	A		

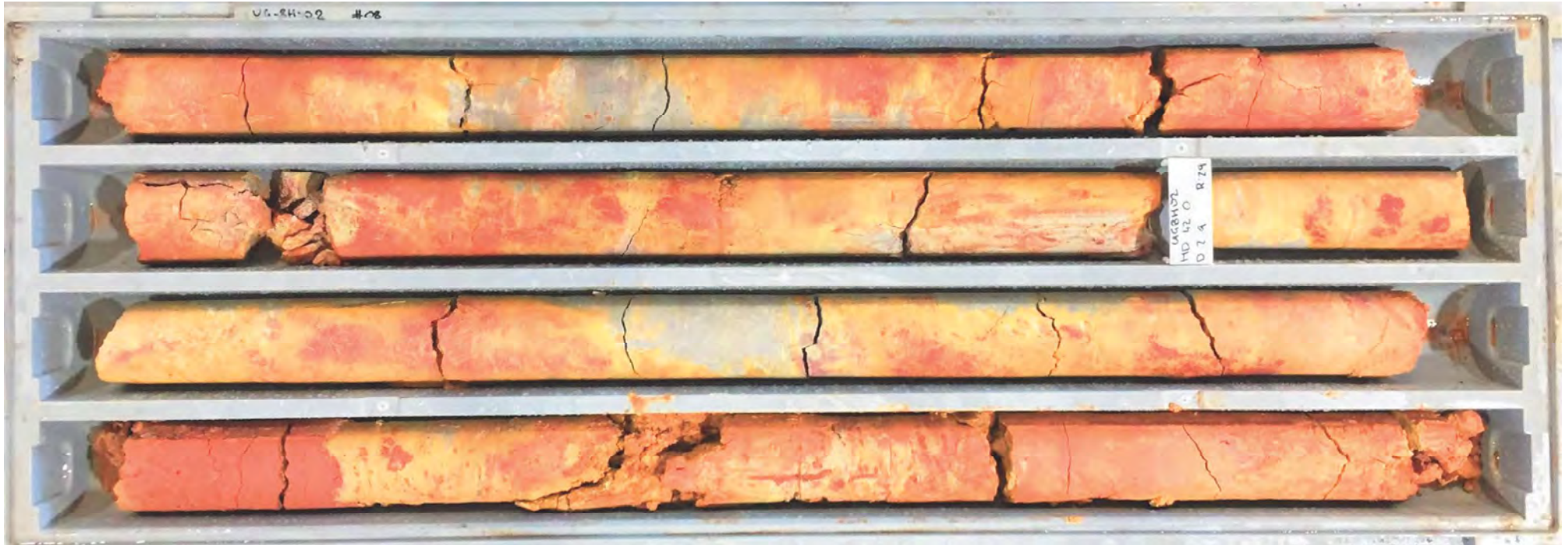

UG-BH-02 40.20 - 44.30 m

drawn	TBM	 A TETRA TECH COMPANY	client:	EMM CONSULTING PTY LTD		
approved	AO		project:	CGO UNDERGROUND DEVELOPMENT EIS COWAL GOLD OPERATIONS		
date	23/03/2020		title:	CORE PHOTOGRAPH UG-BH-02		
scale	N.T.S.		project no:	754-SYDGE206418-3	fig no:	FIGURE 8
original size	A4				rev:	A



UG-BH-02 44.30 - 47.30 m

drawn	TBM		client:	EMM CONSULTING PTY LTD		
approved	AO		project:	CGO UNDERGROUND DEVELOPMENT EIS COWAL GOLD OPERATIONS		
date	23/03/2020		title:	CORE PHOTOGRAPH UG-BH-02		
scale	N.T.S.		project no:	754-SYDGE206418-3	fig no:	FIGURE 9
original size	A4		rev:	A		



UG-BH-02 47.30 - 51.20 m

drawn	TBM		client:	EMM CONSULTING PTY LTD		
approved	AO		project:	CGO UNDERGROUND DEVELOPMENT EIS COWAL GOLD OPERATIONS		
date	23/03/2020		title:	CORE PHOTOGRAPH UG-BH-02		
scale	N.T.S.		project no:	754-SYDGE206418-3	fig no:	FIGURE 10
original size	A4		rev:	A		



UG-BH-02 51.20 - 55.50 m

drawn	TBM		client:	EMM CONSULTING PTY LTD		
approved	AO		project:	CGO UNDERGROUND DEVELOPMENT EIS COWAL GOLD OPERATIONS		
date	23/03/2020		title:	CORE PHOTOGRAPH UG-BH-02		
scale	N.T.S.		project no:	754-SYDGE206418-3	fig no:	FIGURE 11
original size	A4				rev:	A



UG-BH-02 55.50 - 59.90 m

drawn	TBM		client:	EMM CONSULTING PTY LTD		
approved	AO		project:	CGO UNDERGROUND DEVELOPMENT EIS COWAL GOLD OPERATIONS		
date	23/03/2020		title:	CORE PHOTOGRAPH UG-BH-02		
scale	N.T.S.		project no:	754-SYDGE206418-3	fig no:	FIGURE 12
original size	A4		rev:	A		

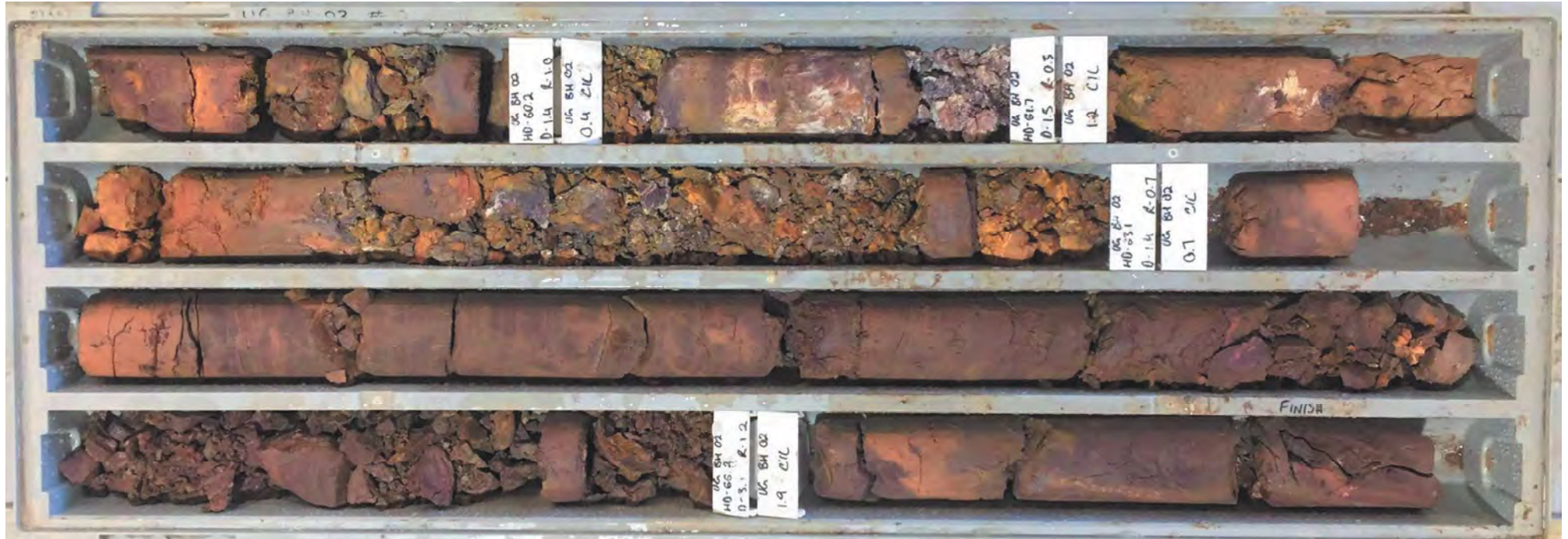

UG-BH-02 59.90 - 66.60 m

drawn	TBM		client:	EMM CONSULTING PTY LTD		
approved	AO		project:	CGO UNDERGROUND DEVELOPMENT EIS COWAL GOLD OPERATIONS		
date	23/03/2020		title:	CORE PHOTOGRAPH UG-BH-02		
scale	N.T.S.		project no:	754-SYDGE206418-3	fig no:	FIGURE 13
original size	A4				rev:	A

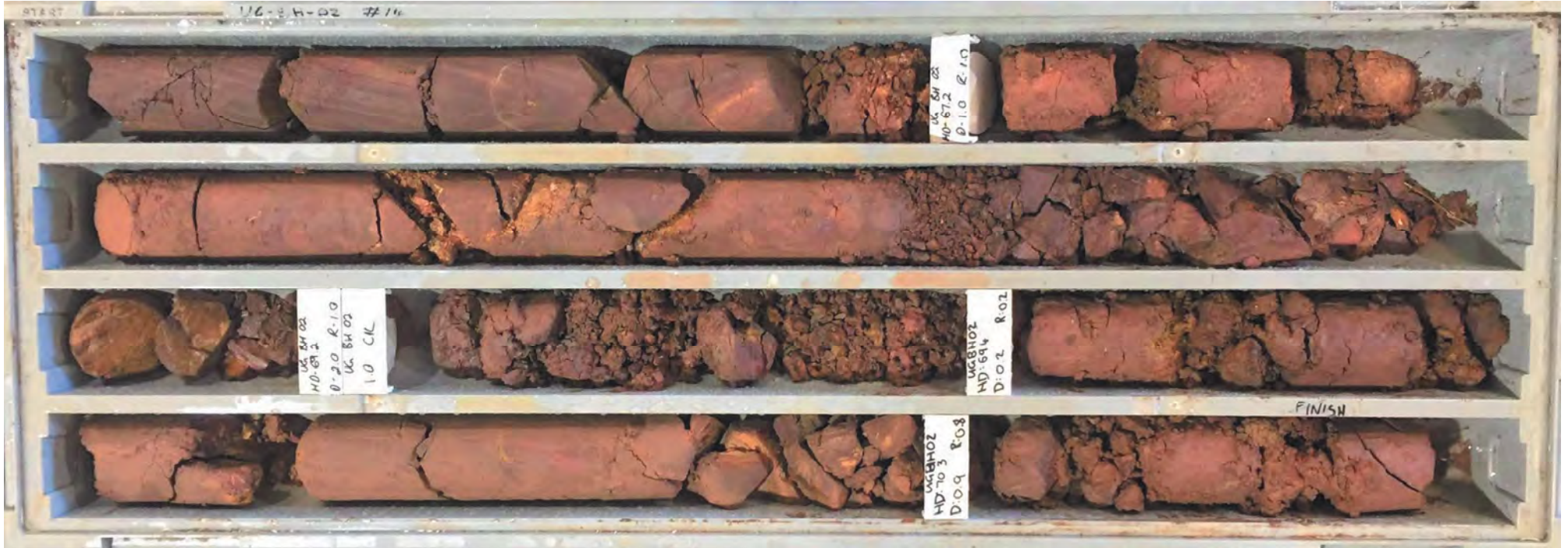

UG-BH-02 66.60 - 70.60 m

drawn	TBM		client:	EMM CONSULTING PTY LTD		
approved	AO		project:	CGO UNDERGROUND DEVELOPMENT EIS COWAL GOLD OPERATIONS		
date	23/03/2020		title:	CORE PHOTOGRAPH UG-BH-02		
scale	N.T.S.		project no:	754-SYDGE206418-3	fig no:	FIGURE 14
original size	A4		rev:	A		



UG-BH-02 70.60 - 74.50 m

drawn	TBM		client:	EMM CONSULTING PTY LTD		
approved	AO		project:	CGO UNDERGROUND DEVELOPMENT EIS COWAL GOLD OPERATIONS		
date	23/03/2020		title:	CORE PHOTOGRAPH UG-BH-02		
scale	N.T.S.		project no:	754-SYDGE206418-3	fig no:	FIGURE 15
original size	A4		rev:	A		

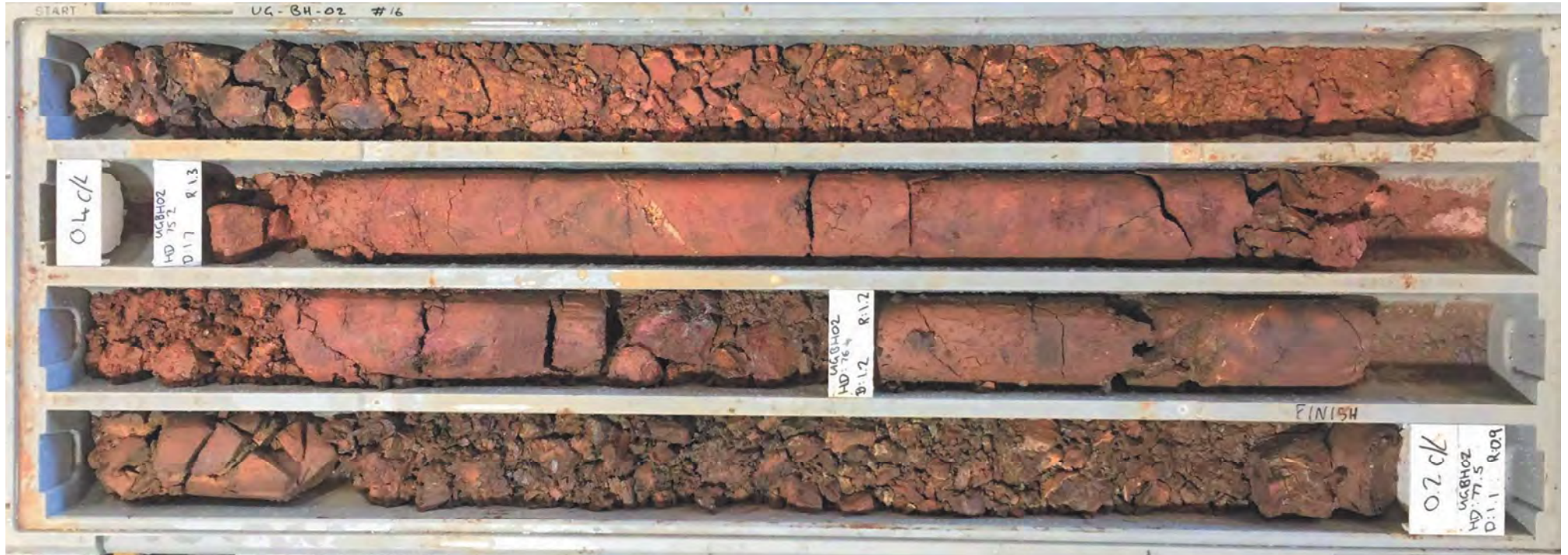

UG-BH-02 74.50 - 77.50 m

drawn	TBM		client:	EMM CONSULTING PTY LTD		
approved	AO		project:	CGO UNDERGROUND DEVELOPMENT EIS COWAL GOLD OPERATIONS		
date	23/03/2020		title:	CORE PHOTOGRAPH UG-BH-02		
scale	N.T.S.		project no:	754-SYDGE206418-3	fig no:	FIGURE 16
original size	A4		rev:	A		



UG-BH-02 77.50 - 81.00 m

drawn	TBM		client:	EMM CONSULTING PTY LTD		
approved	AO		project:	CGO UNDERGROUND DEVELOPMENT EIS COWAL GOLD OPERATIONS		
date	23/03/2020		title:	CORE PHOTOGRAPH UG-BH-02		
scale	N.T.S.		project no:	754-SYDGE206418-3	fig no:	FIGURE 17
original size	A4		rev:	A		



UG-BH-02 81.00 - 84.60 m

drawn	TBM		client:	EMM CONSULTING PTY LTD		
approved	AO		project:	CGO UNDERGROUND DEVELOPMENT EIS COWAL GOLD OPERATIONS		
date	23/03/2020		title:	CORE PHOTOGRAPH UG-BH-02		
scale	N.T.S.		project no:	754-SYDGE206418-3	fig no:	FIGURE 18
original size	A4		rev:	A		

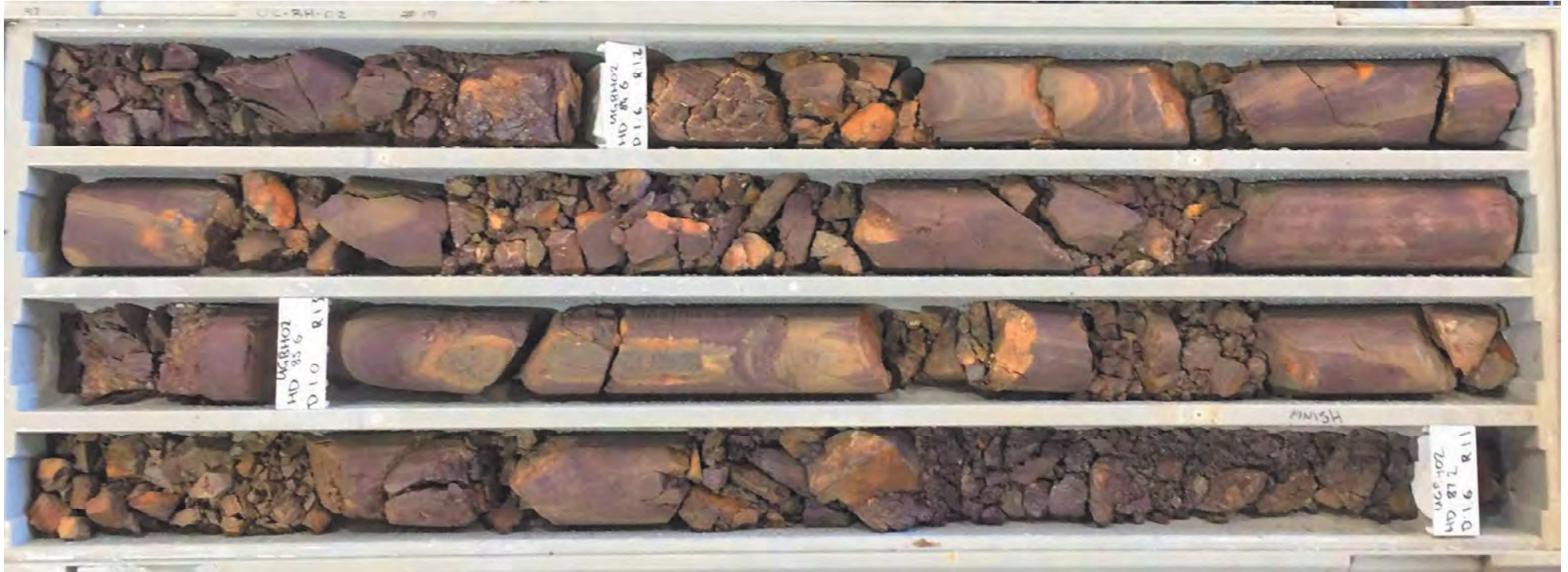

UG-BH-02 84.60 - 87.20 m

drawn	TBM		client:	EMM CONSULTING PTY LTD		
approved	AO		project:	CGO UNDERGROUND DEVELOPMENT EIS COWAL GOLD OPERATIONS		
date	23/03/2020		title:	CORE PHOTOGRAPH UG-BH-02		
scale	N.T.S.		project no:	754-SYDGE206418-3	fig no:	FIGURE 19
original size	A4		rev:	A		



UG-BH-02 87.20 - 90.50 m

drawn	TBM		client:	EMM CONSULTING PTY LTD		
approved	AO		project:	CGO UNDERGROUND DEVELOPMENT EIS COWAL GOLD OPERATIONS		
date	23/03/2020		title:	CORE PHOTOGRAPH UG-BH-02		
scale	N.T.S.		project no:	754-SYDGE206418-3	fig no:	FIGURE 20
original size	A4		rev:	A		



UG-BH-02 90.50 - 96.10 m

drawn	TBM		client: EMM CONSULTING PTY LTD		
approved	AO		project: CGO UNDERGROUND DEVELOPMENT EIS COWAL GOLD OPERATIONS		
date	23/03/2020		title: CORE PHOTOGRAPH UG-BH-02		
scale	N.T.S.		project no: 754-SYDGE206418-3	fig no: FIGURE 21	rev: A
original size	A4				



UG-BH-02 96.10 - 100.40 m

drawn	TBM		client: EMM CONSULTING PTY LTD		
approved	AO		project: CGO UNDERGROUND DEVELOPMENT EIS COWAL GOLD OPERATIONS		
date	23/03/2020		title: CORE PHOTOGRAPH UG-BH-02		
scale	N.T.S.		project no: 754-SYDGE206418-3	fig no: FIGURE 22	rev: A
original size	A4				



UG-BH-02 100.40 - 102.80 m

drawn	TBM		client:	EMM CONSULTING PTY LTD		
approved	AO		project:	CGO UNDERGROUND DEVELOPMENT EIS COWAL GOLD OPERATIONS		
date	23/03/2020		title:	CORE PHOTOGRAPH UG-BH-02		
scale	N.T.S.		project no:	754-SYDGE206418-3	fig no:	FIGURE 23
original size	A4		rev:	A		

Engineering Log - Borehole

client: **EMM CONSULTING PTY LTD**
 principal: **Evolution Mining**
 project: **CGO UNDERGROUND DEVELOPMENT EIS**
 location: **COWAL GOLD OPERATIONS**

Borehole ID: **UG-BH-03**
 sheet: 1 of 10
 project no: **754-SYDGE206418-3**
 date started: **16 Feb 2020**
 date completed: **20 Feb 2020**
 logged by: **TBM**
 checked by: **PLV**

position: Not Specified surface elevation: Not Specified angle from horizontal: -90°
 drill model: Sandvik DE840, Truck mounted drilling fluid: PAK-R casing diameter: PVC150/PW

drilling information				material substance								
method & support	penetration	water	samples & field tests	RL (m)	depth (m)	graphic log	soil group symbol	material description	moisture condition	consistency / relative density	hand penetrometer (kPa)	structure and additional observations
AD/T	150 mm PVC casing	Not Observable			1.0 2.0 3.0 4.0 5.0 6.0 7.0							LACUSTRINE
								Start of coring at 5.5m CORE LOSS 0.8M.				
								CLAY: high plasticity, pale grey, with silt and trace fine to medium grained sand.				
								7.1 m: becoming pale grey mottled orange/brown, with fine to medium grained, sub-angular gravel and fine to coarse grained sand				Gravels found amongst orange/brown mottling - likely rich in iron Core Run (7.3-8.3 m)
								7.6 m: horizontal bands of red/brown appearing, with increased gravel content (Gravelly CLAY)				

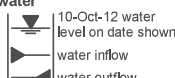
method AD auger drilling* AS auger screwing* HA hand auger W washbore	support M mud C casing N nil	samples & field tests B bulk disturbed sample D disturbed sample E environmental sample SS split spoon sample U## undisturbed sample ##mm diameter HP hand penetrometer (kPa) N standard penetration test (SPT) N* SPT - sample recovered Nc SPT with solid cone VS vane shear; peak/remoulded (kPa) R refusal HB hammer bouncing	soil group symbol & soil description based on AS 1726:2017	consistency / relative density VS very soft S soft F firm St stiff VSt very stiff H hard Fb friable VL very loose L loose MD medium dense D dense VD very dense
* bit shown by suffix e.g. AD/T B blank bit T TC bit V V bit	penetration  no resistance ranging to refusal	moisture condition D dry M moist W wet Wp plastic limit WI liquid limit		
	water 10-Oct-12 water level on date shown  water inflow water outflow			

CDF_0_9_07_LIBRARY.GLB rev:AU Log COF BOREHOLE: NON CORED 754-SYDGE206418-3.GPJ <<DrawingFile>> 27/03/2020 09:20

Engineering Log - Borehole

client: **EMM CONSULTING PTY LTD**
principal: **Evolution Mining**
project: **CGO UNDERGROUND DEVELOPMENT EIS**
location: **COWAL GOLD OPERATIONS**

Borehole ID: **UG-BH-03**
sheet: 2 of 10
project no: **754-SYDGE206418-3**
date started: **16 Feb 2020**
date completed: **20 Feb 2020**
logged by: **TBM**
checked by: **PLV**

position: Not Specified surface elevation: Not Specified angle from horizontal: -90°
drill model: Sandvik DE840, Truck mounted drilling fluid: PAK-R casing diameter: PVC150/PW

drilling information				material substance								
method & support	penetration	water	samples & field tests	RL (m)	depth (m)	graphic log	soil group symbol	material description	moisture condition	consistency / relative density	hand penetrometer (kPa)	structure and additional observations
AD	1				9.0			CLAY: high plasticity, pale grey, with bands of red/brown, with fine to coarse grained sand, silt and fine to medium grained, sub-angular gravel, particularly in the red/brown bands (as above). 8.5 m: red/brown bands becoming pockets of red/brown 9.6 m: becoming red/brown with pockets of pale grey, gravels becoming fine to coarse grained 14.1 m: sand and gravel content increasing 14.5 to 14.6 m: band of Gravelly SAND, fine to coarse grained, red/brown gravel is sub-rounded, fine to medium grained, with fines CORE LOSS 1.0M.				LACUSTRINE Core Run (8.3-9.2 m) Core Run (9.2-10.1 m) Core Run (10.1-10.3 m) Core Run (10.3-12.4 m) Core Run (12.4-13.5 m) Core Run (13.5-14.7 m) Core loss suggests that gravelly sand layer found in recovery across all sections of the core lost due to drilling method Core Run (14.7-15.3 m) Core Run (15.3-15.8 m) Core Run (15.8-16.7 m)
					15.0			Gravelly SAND: fine to coarse grained, red/brown, gravel is sub-rounded, fine to medium grained, with				

method AD auger drilling* AS auger screwing* HA hand auger W washbore * bit shown by suffix e.g. AD/T B blank bit T TC bit V V bit	support M mud N nil C casing penetration no resistance ranging to refusal water 10-Oct-12 water level on date shown water inflow water outflow	samples & field tests B bulk disturbed sample D disturbed sample E environmental sample SS split spoon sample U## undisturbed sample ##mm diameter HP hand penetrometer (kPa) N standard penetration test (SPT) N* SPT - sample recovered Nc SPT with solid cone VS vane shear; peak/remoulded (kPa) R refusal HB hammer bouncing	soil group symbol & soil description based on AS 1726:2017 moisture condition D dry M moist W wet Wp plastic limit WI liquid limit	consistency / relative density VS very soft S soft F firm St stiff VSt very stiff H hard Fb friable VL very loose L loose MD medium dense D dense VD very dense
---	---	--	---	--

CDF_0_9_07_LIBRARY.GLB rev:AU Log COF BOREHOLE: NON CORED 754-SYDGE206418-3.GPJ <<DrawingFile>> 27/03/2020 09:20

Engineering Log - Borehole

client: **EMM CONSULTING PTY LTD**
principal: **Evolution Mining**
project: **CGO UNDERGROUND DEVELOPMENT EIS**
location: **COWAL GOLD OPERATIONS**

Borehole ID: **UG-BH-03**
sheet: 3 of 10
project no. **754-SYDGE206418-3**
date started: **16 Feb 2020**
date completed: **20 Feb 2020**
logged by: **TBM**
checked by: **PLV**

position: Not Specified surface elevation: Not Specified angle from horizontal: -90°
drill model: Sandvik DE840, Truck mounted drilling fluid: PAK-R casing diameter: PVC150/PW

drilling information				material substance								
method & support	penetration	water	samples & field tests	RL (m)	depth (m)	graphic log	soil group symbol	material description	moisture condition	consistency / relative density	hand penetrometer (kPa)	structure and additional observations
					17.0			fines. CORE LOSS 1.5M.				LACUSTRINE Core Run (16.7-17.9 m)
					18.0			Sandy CLAY: high plasticity, red/brown mottled pale grey, with fine to medium grained sand.				RESIDUAL SOIL Core Run (17.9-19.4 m)
					19.0			19.0 m: manganese stained veins appearing, recovered sample beginning to show rock-like structure CORE LOSS 0.4M.				EXTREMELY WEATHERED ROCK Core loss likely indicates extremely weathered rock is being broken up and lost during drilling Core Run (19.4-21.2 m)
					20.0			Sandy CLAY: red/brown mottled orange and pale grey, sand is fine to coarse grained, with fine to medium grained, angular gravel, manganese stained joints observed throughout.				
					21.0			CORE LOSS 2.4M.				Core Run (21.2-24.2 m)
					22.0							
					23.0			Sandy CLAY: red/brown mottled orange and pale grey, sand is fine to coarse grained, with fine to medium grained, angular gravel.				

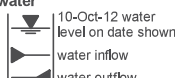
method AD auger drilling* AS auger screwing* HA hand auger W washbore	support M mud C casing N nil	samples & field tests B bulk disturbed sample D disturbed sample E environmental sample SS split spoon sample U## undisturbed sample ##mm diameter HP hand penetrometer (kPa) N standard penetration test (SPT) N* SPT - sample recovered Nc SPT with solid cone VS vane shear, peak/remoulded (kPa) R refusal HB hammer bouncing	soil group symbol & soil description based on AS 1726:2017	consistency / relative density VS very soft S soft F firm St stiff VSt very stiff H hard Fb friable VL very loose L loose MD medium dense D dense VD very dense
* bit shown by suffix e.g. AD/T B blank bit T TC bit V V bit	penetration  no resistance ranging to refusal	water  10-Oct-12 water level on date shown water inflow water outflow	moisture condition D dry M moist W wet Wp plastic limit WI liquid limit	

CDF_0_9_07_LIBRARY.GLB rev:AU Log COF BOREHOLE: NON CORED 754-SYDGE206418-3.GPJ <<DrawingFile>> 27/03/2020 09:20

Engineering Log - Borehole

DRAFT

Borehole ID. **UG-BH-03**
sheet: 4 of 10
project no. **754-SYDGE206418-3**
date started: **16 Feb 2020**
date completed: **20 Feb 2020**
logged by: **TBM**
checked by: **PLV**

client: **EMM CONSULTING PTY LTD**
principal: **Evolution Mining**
project: **CGO UNDERGROUND DEVELOPMENT EIS**
location: **COWAL GOLD OPERATIONS**

position: Not Specified surface elevation: Not Specified angle from horizontal: -90°
drill model: Sandvik DE840, Truck mounted drilling fluid: PAK-R casing diameter: PVC150/PW

drilling information				material substance										
method & support	1 penetration	2 penetration	3 penetration	water	samples & field tests	RL (m)	depth (m)	graphic log	soil group symbol	material description	moisture condition	consistency / relative density	hand penetrometer (kPa)	structure and additional observations
				Not Observable			25.0			Sandy CLAY: red/brown mottled orange and pale grey, sand is fine to coarse grained, with fine to medium grained, angular gravel. <i>(continued)</i> 24.4 m: becoming brown mottled red/brown 27.6 to 28.1 m: fine to coarse grained, quartz gravels appearing in bands 28.1 m: becoming brown				EXTREMELY WEATHERED ROCK Core Run (24.2-24.9 m) Core Run (24.9-25.5 m) Core Run (25.5-26.5 m) Core Run (26.5-27.1 m) Core Run (27.1-27.6 m) Core Run (27.6-28.1 m) Core Run (28.1-29.6 m)
							29.0			Borehole UG-BH-03 continued as cored hole				
							30.0							
							31.0							

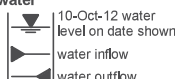
method AD auger drilling* AS auger screwing* HA hand auger W washbore * bit shown by suffix e.g. AD/T B blank bit T TC bit V V bit	support M mud N nil C casing penetration  no resistance ranging to refusal water  10-Oct-12 water level on date shown water inflow water outflow	samples & field tests B bulk disturbed sample D disturbed sample E environmental sample SS split spoon sample U## undisturbed sample ##mm diameter HP hand penetrometer (kPa) N standard penetration test (SPT) N* SPT - sample recovered Nc SPT with solid cone VS vane shear; peak/remoulded (kPa) R refusal HB hammer bouncing	soil group symbol & soil description based on AS 1726:2017 moisture condition D dry M moist W wet Wp plastic limit WI liquid limit	consistency / relative density VS very soft S soft F firm St stiff VSt very stiff H hard Fb friable VL very loose L loose MD medium dense D dense VD very dense
--	--	--	---	--

CDF_0_9_07_LIBRARY.GLB rev:AU Log COF BOREHOLE: NON CORED 754-SYDGE206418-3.GPJ <<DrawingFile>> 27/03/2020 09:20

Engineering Log - Cored Borehole

Borehole ID: **UG-BH-03**
 sheet: 5 of 10
 project no: **754-SYDGE206418-3**
 date started: **16 Feb 2020**
 date completed: **20 Feb 2020**
 logged by: **TBM**
 checked by: **PLV**

client: **EMM CONSULTING PTY LTD**
 principal: **Evolution Mining**
 project: **CGO UNDERGROUND DEVELOPMENT EIS**
 location: **COWAL GOLD OPERATIONS**

position: Not Specified surface elevation: Not Specified angle from horizontal: -90°
 drill model: Sandvik DE840, Truck mounted drilling fluid: PAK-R casing diameter: PVC150/PW

drilling information		material substance				rock mass defects						
method & support	water	RL (m)	depth (m)	graphic log	material description ROCK TYPE: grain characteristics, colour, structure, minor components	weathering & alteration	estimated strength & Is50 X = axial O = diametral a = axial d = diametral	samples, field tests & Is(50) (MPa)	core run & RQD	defect spacing (mm)	additional observations and defect descriptions (type, inclination, planarity, roughness, coating, thickness, other)	
											particular	general
			25.0									
			26.0									
			27.0									
			28.0									
			28.50		started coring at 28.50m							
			29.0	X	ANDESITE: fine to medium grained, orange/brown, porphyritic, heavily fractured along planes at 0-45° showing extensive iron oxide and manganese staining.	XW - HW						
			30.0		CORE LOSS 0.6M.							
			31.0	X	ANDESITE: fine to medium grained, orange/brown, porphyritic, heavily fractured along planes at 0-45° showing extensive iron oxide and manganese staining.	XW - HW						
			31.40		31.40 m: becoming brown and pale grey							

method & support AS auger screwing AD auger drilling CB claw or blade bit W washbore RR rock roller NMLCNMLC core (51.9 mm) NQ wireline core (47.6mm) HQ wireline core (63.5mm) PQ wireline core (85.0mm)	support C casing M mud N none water 10/10/12, water level on date shown water inflow complete drilling fluid loss partial drilling fluid loss water pressure test result (lugeons) for depth interval shown	graphic log / core recovery core recovered (graphic symbols indicate material) no core recovered core run & RQD barrel withdrawn RQD = Rock Quality Designation (%)	weathering & alteration* RS residual soil XW extremely weathered HW highly weathered MW moderately weathered SW slightly weathered FR fresh *W replaced with A for alteration strength VL very low L low M medium H high VH very high EH extremely high	defect type PT parting JT joint SS shear surface SZ shear zone CO contact CS crushed seam SM seam roughness VR very rough RO rough SO smooth POL polished SL slickensided	planarity PL planar CU curved UN undulating ST stepped IR irregular coating CN clean SN stained VN veneer CO coating
---	--	--	---	--	--

CDF_0_9_07_LIBRARY\GLB rev\AU Log_COF_BOREHOLE: CORED 754-SYDGE206418-3.GPJ <<DrawingFile>> 27/03/2020 09:21



Engineering Log - Cored Borehole

Borehole ID: **UG-BH-03**
 sheet: 6 of 10
 project no: **754-SYDGE206418-3**
 date started: **16 Feb 2020**
 date completed: **20 Feb 2020**
 logged by: **TBM**
 checked by: **PLV**

client: **EMM CONSULTING PTY LTD**
 principal: **Evolution Mining**
 project: **CGO UNDERGROUND DEVELOPMENT EIS**
 location: **COWAL GOLD OPERATIONS**

position: Not Specified surface elevation: Not Specified angle from horizontal: -90°
 drill model: Sandvik DE840, Truck mounted drilling fluid: PAK-R casing diameter: PVC150/PW

drilling information		material substance				rock mass defects						
method & support	water	RL (m)	depth (m)	graphic log	material description ROCK TYPE: grain characteristics, colour, structure, minor components	weathering & alteration	estimated strength & Is(50)	samples, field tests & Is(50) (MPa)	core run & RQD	defect spacing (mm)	additional observations and defect descriptions (type, inclination, planarity, roughness, coating, thickness, other)	
							X = axial O = diametral a = axial d = diametral			30 100 300 1000 3000	particular	general
			33.0		ANDESITE: fine to medium grained, orange/brown, porphyritic, heavily fractured along planes at 0-45° showing extensive iron oxide and manganese staining. (continued)	XW - HW						
			34.0									
			35.0		CORE LOSS 1.3M.							
			36.0									
			37.0		ANDESITE: fine to medium grained, brown and pale grey, porphyritic, heavily fractured along planes at 0-45° showing extensive iron oxide and manganese staining.	XW - HW						
			38.0			HW - MW						
			39.0			XW - HW						
					CORE LOSS 1.1M.							

method & support AS auger screwing AD auger drilling CB claw or blade bit W washbore RR rock roller NMLCNMLC core (51.9 mm) NQ wireline core (47.6mm) HQ wireline core (63.5mm) PQ wireline core (85.0mm)	support C casing M mud N none water 10/10/12, water level on date shown water inflow complete drilling fluid loss partial drilling fluid loss water pressure test result (lugeons) for depth interval shown	graphic log / core recovery core recovered (graphic symbols indicate material) no core recovered core run & RQD barrel withdrawn RQD = Rock Quality Designation (%)	weathering & alteration* RS residual soil XW extremely weathered HW highly weathered MW moderately weathered SW slightly weathered FR fresh *W replaced with A for alteration strength VL very low L low M medium H high VH very high EH extremely high	defect type PT parting JT joint SS shear surface SZ shear zone CO contact CS crushed seam SM seam roughness VR very rough RO rough SO smooth POL polished SL slickensided	planarity PL planar CU curved UN undulating ST stepped IR irregular coating CN clean SN stained VN veneer CO coating
---	--	--	---	--	--









Engineering Log - Cored Borehole

Borehole ID. **UG-BH-03**
 sheet: 7 of 10
 project no. **754-SYDGE206418-3**
 date started: **16 Feb 2020**
 date completed: **20 Feb 2020**
 logged by: **TBM**
 checked by: **PLV**

client: **EMM CONSULTING PTY LTD**
 principal: **Evolution Mining**
 project: **CGO UNDERGROUND DEVELOPMENT EIS**
 location: **COWAL GOLD OPERATIONS**

position: Not Specified surface elevation: Not Specified angle from horizontal: -90°
 drill model: Sandvik DE840, Truck mounted drilling fluid: PAK-R casing diameter: PVC150/PW

drilling information		material substance				rock mass defects						
method & support	water	RL (m)	depth (m)	graphic log	material description ROCK TYPE: grain characteristics, colour, structure, minor components	weathering & alteration	estimated strength & Is50 X = axial O = diametral a = axial d = diametral	samples, field tests & Is(50) (MPa)	core run & RQD	defect spacing (mm)	additional observations and defect descriptions (type, inclination, planarity, roughness, coating, thickness, other)	
											particular	general
					CORE LOSS 1.1M. (continued)							
			41.0		ANDESITE: fine to medium grained, brown and pale grey, porphyritic, heavily fractured along planes at 0-45° showing extensive iron oxide and manganese staining.	XW - HW						
			42.0									
			43.0									
			44.0									
			45.0									
			46.0									
			47.0		CORE LOSS 1.0M.							
						XW - HW						

method & support AS auger screwing AD auger drilling CB claw or blade bit W washbore RR rock roller NMLCNMLC core (51.9 mm) NQ wireline core (47.6mm) HQ wireline core (63.5mm) PQ wireline core (85.0mm)	support C casing M mud N none water  10/10/12, water level on date shown  water inflow  complete drilling fluid loss  partial drilling fluid loss  water pressure test result (lugeons) for depth interval shown	graphic log / core recovery  core recovered (graphic symbols indicate material)  no core recovered core run & RQD  barrel withdrawn RQD = Rock Quality Designation (%)	weathering & alteration* RS residual soil XW extremely weathered HW highly weathered MW moderately weathered SW slightly weathered FR fresh *W replaced with A for alteration strength VL very low L low M medium H high VH very high EH extremely high	defect type PT parting JT joint SS shear surface SZ shear zone CO contact CS crushed seam SM seam roughness VR very rough RO rough SO smooth POL polished SL slickensided	planarity PL planar CU curved UN undulating ST stepped IR irregular coating CN clean SN stained VN veneer CO coating
---	--	--	---	--	--

Engineering Log - Cored Borehole

Borehole ID. **UG-BH-03**
 sheet: 8 of 10
 project no. **754-SYDGE206418-3**
 date started: **16 Feb 2020**
 date completed: **20 Feb 2020**
 logged by: **TBM**
 checked by: **PLV**

client: **EMM CONSULTING PTY LTD**
 principal: **Evolution Mining**
 project: **CGO UNDERGROUND DEVELOPMENT EIS**
 location: **COWAL GOLD OPERATIONS**

position: Not Specified surface elevation: Not Specified angle from horizontal: -90°
 drill model: Sandvik DE840, Truck mounted drilling fluid: PAK-R casing diameter: PVC150/PW

drilling information		material substance				rock mass defects						
method & support	water	RL (m)	depth (m)	graphic log	material description	weathering & alteration	estimated strength & Is50	samples, field tests & Is(50) (MPa)	core run & RQD	defect spacing (mm)	additional observations and defect descriptions (type, inclination, planarity, roughness, coating, thickness, other)	
					ROCK TYPE: grain characteristics, colour, structure, minor components		X = axial O = diametral	a = axial d = diametral			particular	general
			49.0		ANDESITE: fine to medium grained, brown and pale grey, porphyritic, heavily fractured along planes at 0-45° showing extensive iron oxide and manganese staining. (continued)	XW - HW						
			50.0		49.40 m: bands of highly weathered, medium strength rock appearing up to 150mm thick	XW - HW						
			51.0									
			52.0									
			53.0		CORE LOSS 0.6M.							
			54.0		ANDESITE: fine to medium grained, brown and pale grey, porphyritic, heavily fractured along planes at 0-45°.	HW						
			55.0									

CDF_0_9_07_LIBRARY.GLB rev.AU Log_COF_BOREHOLE: CORED 754-SYDGE206418-3.GPJ <<DrawingFile>> 27/03/2020 09:21

method & support AS auger screwing AD auger drilling CB claw or blade bit W washbore RR rock roller NMLCNMLC core (51.9 mm) NQ wireline core (47.6mm) HQ wireline core (63.5mm) PQ wireline core (85.0mm)	support C casing M mud N none water 10/10/12, water level on date shown water inflow complete drilling fluid loss partial drilling fluid loss water pressure test result (lugeons) for depth interval shown	graphic log / core recovery core recovered (graphic symbols indicate material) no core recovered core run & RQD barrel withdrawn RQD = Rock Quality Designation (%)	weathering & alteration* RS residual soil XW extremely weathered HW highly weathered MW moderately weathered SW slightly weathered FR fresh *W replaced with A for alteration strength VL very low L low M medium H high VH very high EH extremely high	defect type PT parting JT joint SS shear surface SZ shear zone CO contact CS crushed seam SM seam roughness VR very rough RO rough SO smooth POL polished SL slickensided	planarity PL planar CU curved UN undulating ST stepped IR irregular coating CN clean SN stained VN veneer CO coating
---	--	--	---	--	--

Engineering Log - Cored Borehole

Borehole ID. **UG-BH-03**
 sheet: 9 of 10
 project no. **754-SYDGE206418-3**
 date started: **16 Feb 2020**
 date completed: **20 Feb 2020**
 logged by: **TBM**
 checked by: **PLV**

client: **EMM CONSULTING PTY LTD**
 principal: **Evolution Mining**
 project: **CGO UNDERGROUND DEVELOPMENT EIS**
 location: **COWAL GOLD OPERATIONS**

position: Not Specified surface elevation: Not Specified angle from horizontal: -90°
 drill model: Sandvik DE840, Truck mounted drilling fluid: PAK-R casing diameter: PVC150/PW

drilling information		material substance				rock mass defects						
method & support	water	RL (m)	depth (m)	graphic log	material description ROCK TYPE: grain characteristics, colour, structure, minor components	weathering & alteration	estimated strength & Is50 X = axial O = diametral a = axial d = diametral	samples, field tests & Is(50) (MPa)	core run & RQD	defect spacing (mm)	additional observations and defect descriptions (type, inclination, planarity, roughness, coating, thickness, other)	
							VL L M H VH EH			30 100 300 1000 3000	particular	general
			57.0	X	ANDESITE: fine to medium grained, brown and pale grey, porphyritic, heavily fractured along planes at 0-45°. (continued)	HW						
					CORE LOSS 1.2M.							
			58.0	X	ANDESITE: fine to medium grained, brown and pale grey, porphyritic, heavily fractured along planes at 0-45°.	XW - HW						
					CORE LOSS 0.4M.							
			59.0	X	ANDESITE: fine to medium grained, brown and pale grey, porphyritic, heavily fractured along planes at 0-45°.	XW - HW						
			60.0	X								
			61.0	X								
			62.0	X		HW						
			63.0	X		HW - MW						

Clay seams up to 200mm thick, 0-65° and planar, spaced sporadically every 200-400MM

CDF_0_9_07_LIBRARY.GLB rev:AU Log COF BOREHOLE: CORED 754-SYDGE206418-3.GPJ <<DrawingFile>> 27/03/2020 09:21

method & support AS auger screwing AD auger drilling CB claw or blade bit W washbore RR rock roller NMLCNMLC core (51.9 mm) NQ wireline core (47.6mm) HQ wireline core (63.5mm) PQ wireline core (85.0mm)	support C casing M mud N none water 10/10/12, water level on date shown water inflow complete drilling fluid loss partial drilling fluid loss water pressure test result (lugeons) for depth interval shown	graphic log / core recovery core recovered (graphic symbols indicate material) no core recovered core run & RQD barrel withdrawn RQD = Rock Quality Designation (%)	weathering & alteration* RS residual soil XW extremely weathered HW highly weathered MW moderately weathered SW slightly weathered FR fresh *W replaced with A for alteration strength VL very low L low M medium H high VH very high EH extremely high	defect type PT parting JT joint SS shear surface SZ shear zone CO contact CS crushed seam SM seam roughness VR very rough RO rough SO smooth POL polished SL slickensided	planarity PL planar CU curved UN undulating ST stepped IR irregular coating CN clean SN stained VN veneer CO coating
---	--	--	---	--	--

Engineering Log - Cored Borehole

client: **EMM CONSULTING PTY LTD**
principal: **Evolution Mining**
project: **CGO UNDERGROUND DEVELOPMENT EIS**
location: **COWAL GOLD OPERATIONS**

Borehole ID: **UG-BH-03**
sheet: 10 of 10
project no. **754-SYDGE206418-3**
date started: **16 Feb 2020**
date completed: **20 Feb 2020**
logged by: **TBM**
checked by: **PLV**

position: Not Specified surface elevation: Not Specified angle from horizontal: -90°
drill model: Sandvik DE840, Truck mounted drilling fluid: PAK-R casing diameter: PVC150/PW

drilling information		material substance				rock mass defects						
method & support	water	RL (m)	depth (m)	graphic log	material description	weathering & alteration	estimated strength & Is(50)	samples, field tests & Is(50) (MPa)	core run & RQD	defect spacing (mm)	additional observations and defect descriptions	
					ROCK TYPE: grain characteristics, colour, structure, minor components		VL L M H VH EH	a = axial d = diametral		30 100 300 1000 3000	(type, inclination, planarity, roughness, coating, thickness, other)	
											particular	general
			65.0		ANDESITE: fine to medium grained, brown and pale grey, porphyritic, heavily fractured along planes at 0-45°. <i>(continued)</i>	HW - MW						
			66.0		65.60 m: quartz veins up to 5mm thick, typically 35°-55° and intersecting one another perpendicularly, appearing	MW					JT, 45°, PL, SO, Clay CO	Fracturing noted previously has become less noticeable, manganese/iron oxide staining less obvious and not as noticeably affecting the strength of the rock
			67.0		65.80 m: small pockets of rock appearing to be slightly weathered to fresh, containing traces of pyrite crystals						JT, 23°, PL, SO, Clay CO	
			68.0								JT, 45°, PL, SO, Clay CO	
			69.0								JT, 45°, PL, SO, Clay CO	
			70.0								JT, 45°, PL, SO, Clay CO	
			71.0								JT, 55°, PL, SO, Clay CO	
											JT, 40°, PL, SO, Clay CO	
											JT, 10°, PL, SO, Clay CO	
					Borehole UG-BH-03 terminated at 72.00 m Target depth							

method & support AS auger screwing AD auger drilling CB claw or blade bit W washbore RR rock roller NMLCNMLC core (51.9 mm) NQ wireline core (47.6mm) HQ wireline core (63.5mm) PQ wireline core (85.0mm)	support C casing M mud N none water 10/10/12, water level on date shown water inflow complete drilling fluid loss partial drilling fluid loss water pressure test result (lugeons) for depth interval shown	graphic log / core recovery core recovered (graphic symbols indicate material) no core recovered core run & RQD barrel withdrawn RQD = Rock Quality Designation (%)	weathering & alteration* RS residual soil XW extremely weathered HW highly weathered MW moderately weathered SW slightly weathered FR fresh *W replaced with A for alteration strength VL very low L low M medium H high VH very high EH extremely high	defect type PT parting JT joint SS shear surface SZ shear zone CO contact CS crushed seam SM seam roughness VR very rough RO rough SO smooth POL polished SL slickensided	planarity PL planar CU curved UN undulating ST stepped IR irregular coating CN clean SN stained VN veneer CO coating
---	--	--	---	--	--

CDF_0_9_07_LIBRARY.GLB rev:AU Log COF BOREHOLE: CORED 754-SYDGE206418-3.GPJ <<DrawingFile>> 27/03/2020 09:21



UG-BH-03 5.50 - 9.90 m

drawn	TBM		client:	EMM CONSULTING PTY LTD		
approved	AO		project:	CGO UNDERGROUND DEVELOPMENT EIS COWAL GOLD OPERATIONS		
date	23/03/2020		title:	CORE PHOTOGRAPH UG-BH-03		
scale	N.T.S.		project no:	754-SYDGE206418-3	fig no:	FIGURE 1
original size	A4		rev:	A		



UG-BH-03 9.90 - 13.45 m

drawn	TBM		client:	EMM CONSULTING PTY LTD		
approved	AO		project:	CGO UNDERGROUND DEVELOPMENT EIS COWAL GOLD OPERATIONS		
date	23/03/2020		title:	CORE PHOTOGRAPH UG-BH-03		
scale	N.T.S.		project no:	754-SYDGE206418-3	fig no:	FIGURE 2
original size	A4				rev:	A



UG-BH-03 13.45 - 19.40 m

drawn	TBM		client:	EMM CONSULTING PTY LTD	
approved	AO		project:	CGO UNDERGROUND DEVELOPMENT EIS COWAL GOLD OPERATIONS	
date	23/03/2020		title:	CORE PHOTOGRAPH UG-BH-03	
scale	N.T.S.				
original size	A4		project no:	754-SYDGE206418-3	fig no:
				rev:	A



UG-BH-03 19.40 - 25.60 m

drawn	TBM		client:	EMM CONSULTING PTY LTD		
approved	AO		project:	CGO UNDERGROUND DEVELOPMENT EIS COWAL GOLD OPERATIONS		
date	23/03/2020		title:	CORE PHOTOGRAPH UG-BH-03		
scale	N.T.S.		project no:	754-SYDGE206418-3	fig no:	FIGURE 4
original size	A4				rev:	A



UG-BH-03 25.60 - 28.30 m

drawn	TBM		client:	EMM CONSULTING PTY LTD		
approved	AO		project:	CGO UNDERGROUND DEVELOPMENT EIS COWAL GOLD OPERATIONS		
date	23/03/2020		title:	CORE PHOTOGRAPH UG-BH-03		
scale	N.T.S.		project no:	754-SYDGE206418-3	fig no:	FIGURE 5
original size	A4				rev:	A



UG-BH-03 28.30 - 32.60 m

drawn	TBM		client:	EMM CONSULTING PTY LTD		
approved	AO		project:	CGO UNDERGROUND DEVELOPMENT EIS COWAL GOLD OPERATIONS		
date	23/03/2020		title:	CORE PHOTOGRAPH UG-BH-03		
scale	N.T.S.		project no:	754-SYDGE206418-3	fig no:	FIGURE 6
original size	A4				rev:	A

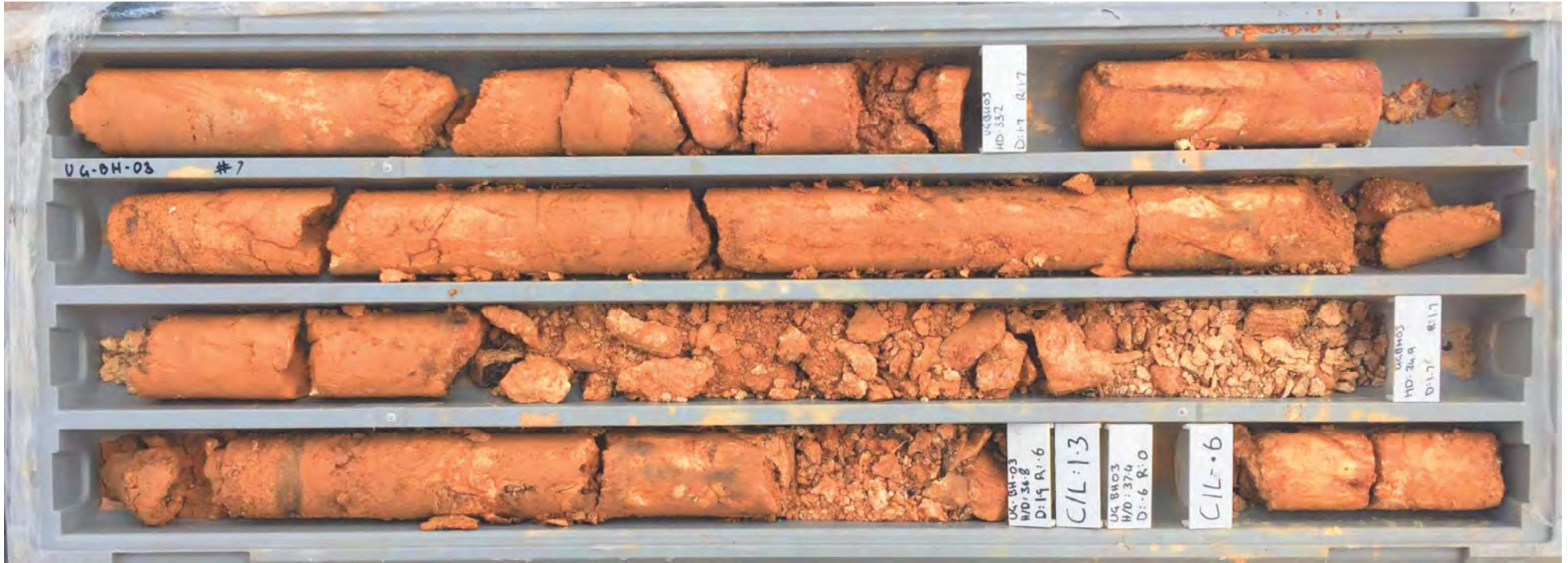

UG-BH-03 32.60 - 37.60 m

drawn	TBM		client:	EMM CONSULTING PTY LTD				
approved	AO		project:	CGO UNDERGROUND DEVELOPMENT EIS COWAL GOLD OPERATIONS				
date	23/03/2020		title:	CORE PHOTOGRAPH UG-BH-03				
scale	N.T.S.		project no:	754-SYDGE206418-3	fig no:	FIGURE 7	rev:	A
original size	A4							



UG-BH-03 37.60 - 41.50 m

drawn	TBM		client:	EMM CONSULTING PTY LTD		
approved	AO		project:	CGO UNDERGROUND DEVELOPMENT EIS COWAL GOLD OPERATIONS		
date	23/03/2020		title:	CORE PHOTOGRAPH UG-BH-03		
scale	N.T.S.		project no:	754-SYDGE206418-3	fig no:	FIGURE 8
original size	A4		rev:	A		



UG-BH-03 41.50 - 45.20 m

drawn	TBM		client:	EMM CONSULTING PTY LTD		
approved	AO		project:	CGO UNDERGROUND DEVELOPMENT EIS COWAL GOLD OPERATIONS		
date	23/03/2020		title: CORE PHOTOGRAPH UG-BH-03			
scale	N.T.S.		project no:	754-SYDGE206418-3	fig no:	FIGURE 9
original size	A4		rev: A			



UG-BH-03 45.20 - 49.20 m

drawn	TBM		client:	EMM CONSULTING PTY LTD		
approved	AO		project:	CGO UNDERGROUND DEVELOPMENT EIS COWAL GOLD OPERATIONS		
date	23/03/2020		title:	CORE PHOTOGRAPH UG-BH-03		
scale	N.T.S.		project no:	754-SYDGE206418-3	fig no:	FIGURE 10
original size	A4		rev:	A		



UG-BH-03 49.20 - 52.60 m

drawn	TBM		client: EMM CONSULTING PTY LTD		
approved	AO		project: CGO UNDERGROUND DEVELOPMENT EIS COWAL GOLD OPERATIONS		
date	23/03/2020		title: CORE PHOTOGRAPH UG-BH-03		
scale	N.T.S.		project no: 754-SYDGE206418-3	fig no: FIGURE 11	rev: A
original size	A4				



UG-BH-03 52.60 - 56.60 m

drawn	TBM		client:	EMM CONSULTING PTY LTD		
approved	AO		project:	CGO UNDERGROUND DEVELOPMENT EIS COWAL GOLD OPERATIONS		
date	23/03/2020		title:	CORE PHOTOGRAPH UG-BH-03		
scale	N.T.S.		project no:	754-SYDGE206418-3	fig no:	FIGURE 12
original size	A4		rev:	A		



UG-BH-03 56.60 - 61.40 m

drawn	TBM		client:	EMM CONSULTING PTY LTD		
approved	AO		project:	CGO UNDERGROUND DEVELOPMENT EIS COWAL GOLD OPERATIONS		
date	23/03/2020		title:	CORE PHOTOGRAPH UG-BH-03		
scale	N.T.S.		project no:	754-SYDGE206418-3	fig no:	FIGURE 13
original size	A4		rev:	A		



UG-BH-03 61.40 - 64.80 m

drawn	TBM		client:	EMM CONSULTING PTY LTD		
approved	AO		project:	CGO UNDERGROUND DEVELOPMENT EIS COWAL GOLD OPERATIONS		
date	23/03/2020		title:	CORE PHOTOGRAPH UG-BH-03		
scale	N.T.S.		project no:	754-SYDGE206418-3	fig no:	FIGURE 14
original size	A4		rev:	A		



UG-BH-03 64.80 - 68.10 m

drawn	TBM		client:	EMM CONSULTING PTY LTD		
approved	AO		project:	CGO UNDERGROUND DEVELOPMENT EIS COWAL GOLD OPERATIONS		
date	23/03/2020		title:	CORE PHOTOGRAPH UG-BH-03		
scale	N.T.S.		project no:	754-SYDGE206418-3	fig no:	FIGURE 15
original size	A4		rev:	A		



UG-BH-03 68.10 - 71.10 m

drawn	TBM		client:	EMM CONSULTING PTY LTD				
approved	AO		project:	CGO UNDERGROUND DEVELOPMENT EIS COWAL GOLD OPERATIONS				
date	23/03/2020		title:	CORE PHOTOGRAPH UG-BH-03				
scale	N.T.S.		project no:	754-SYDGE206418-3	fig no:	FIGURE 16	rev:	A
original size	A4							



UG-BH-03 71.10 - 72.00 m

drawn	TBM		client: EMM CONSULTING PTY LTD	
approved	AO		project: CGO UNDERGROUND DEVELOPMENT EIS COWAL GOLD OPERATIONS	
date	23/03/2020		title: CORE PHOTOGRAPH UG-BH-03	
scale	N.T.S.			
original size	A4		project no: 754-SYDGE206418-3	fig no: FIGURE 17

Engineering Log - Borehole

client: **EMM CONSULTING PTY LTD**
principal: **Evolution Mining**
project: **CGO UNDERGROUND DEVELOPMENT EIS**
location: **COWAL GOLD OPERATIONS**

Borehole ID: **UG-BH-04**
sheet: 1 of 14
project no. **754-SYDGE206418-3**
date started: **20 Feb 2020**
date completed: **23 Feb 2020**
logged by: **TBM**
checked by: **PLV**

position: Not Specified surface elevation: Not Specified angle from horizontal: -90°
drill model: Sandvik DE840, Truck mounted drilling fluid: PAK-R casing diameter: PVC150/PW

drilling information				material substance								
method & support	penetration	water	samples & field tests	RL (m)	depth (m)	graphic log	soil group symbol	material description	moisture condition	consistency / relative density	hand penetrometer (kPa)	structure and additional observations
AD/T	150-RPM (Pak) augering	Not Observable			0.0			Silty CLAY: high plasticity, grey, with fine to medium grained sand and trace fine to medium grained, sub-angular quartz gravel.				LACUSTRINE SOIL
					1.0							
					2.0							
					3.0							
					4.0							
					5.0			Cuttings found at start of hole are presumed to be from cave in, so true depth of material recovered is unknown between 1-5.7m. Material is a clayey SAND, fine to coarse grained, red/brown, clay is highly plastic, with fine grained, sub-rounded gravel				
					5.5			Start of coring at 5.5m				
					6.0			CORE LOSS 0.2M.				Core Run (5.7-6.2 m): 100% recovery
					6.2			CLAY: high plasticity, pale grey mottled orange, with fine to medium grained sand.				Core Run (6.2-8.7 m): 100% recovery
					7.0							
					7.2			7.2 to 7.4 m: iron oxide staining evident				

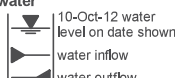
method AD auger drilling* AS auger screwing* HA hand auger W washbore * bit shown by suffix e.g. AD/T B blank bit T TC bit V V bit	support M mud C casing N nil penetration  no resistance ranging to refusal water  10-Oct-12 water level on date shown water inflow water outflow	samples & field tests B bulk disturbed sample D disturbed sample E environmental sample SS split spoon sample U## undisturbed sample ##mm diameter HP hand penetrometer (kPa) N standard penetration test (SPT) N* SPT - sample recovered Nc SPT with solid cone VS vane shear; peak/remoulded (kPa) R refusal HB hammer bouncing	soil group symbol & soil description based on AS 1726:2017 moisture condition D dry M moist W wet Wp plastic limit WI liquid limit	consistency / relative density VS very soft S soft F firm St stiff VSt very stiff H hard Fb friable VL very loose L loose MD medium dense D dense VD very dense
--	--	--	---	--

CDF_0_9_07_LIBRARY.GLB rev:AU Log COF BOREHOLE: NON CORED 754-SYDGE206418-3.GPJ <<DrawingFile>> 27/03/2020 09:20

Engineering Log - Borehole

client: **EMM CONSULTING PTY LTD**
principal: **Evolution Mining**
project: **CGO UNDERGROUND DEVELOPMENT EIS**
location: **COWAL GOLD OPERATIONS**

Borehole ID: **UG-BH-04**
sheet: 2 of 14
project no: **754-SYDGE206418-3**
date started: **20 Feb 2020**
date completed: **23 Feb 2020**
logged by: **TBM**
checked by: **PLV**

position: Not Specified surface elevation: Not Specified angle from horizontal: -90°
drill model: Sandvik DE840, Truck mounted drilling fluid: PAK-R casing diameter: PVC150/PW

drilling information				material substance								
method & support	penetration	water	samples & field tests	RL (m)	depth (m)	graphic log	soil group symbol	material description	moisture condition	consistency / relative density	hand penetrometer (kPa)	structure and additional observations
					9.0			CLAY: high plasticity, pale grey mottled orange, with fine to medium grained sand. (<i>continued</i>) 8.6 m: becoming red/brown mottled pale grey, sand content varying in lenses of heavily varying thickness				LACUSTRINE SOIL Core Run (8.7-10.0 m): 100% recovery
					10.0							Core Run (10.0-12.4 m): 100% recovery
					11.0			Sandy CLAY: high plasticity, red/brown mottled pale grey, sand is fine to medium grained.				RESIDUAL SOIL
					12.0			12.4 to 14.0 m: trace of manganese staining				Core Run (12.4-14.6 m): 100% recovery
					13.0			13.0 m: bands of higher sand content appearing up to 100mm thick				
					14.0							
					14.5			14.5 m: sand becoming fine to coarse grained, with fine to medium grained, sub-angular to sub-rounded gravel appearing				Core Run (14.6-15.4 m): 63% recovery
					15.0			CORE LOSS 0.3M. Sandy CLAY: high plasticity, red/brown mottled pale grey and black, sand is fine to coarse grained, with fine to medium grained, sub-angular to sub-rounded gravel.				Core loss likely indicates higher sand content Core Run (15.4-16.8 m): 100% recovery
												EXTREMELY WEATHERED ROCK

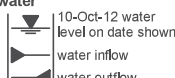
method AD auger drilling* AS auger screwing* HA hand auger W washbore * bit shown by suffix e.g. AD/T B blank bit T TC bit V V bit	support M mud C casing N nil penetration  no resistance ranging to refusal water  10-Oct-12 water level on date shown water inflow water outflow	samples & field tests B bulk disturbed sample D disturbed sample E environmental sample SS split spoon sample U## undisturbed sample ##mm diameter HP hand penetrometer (kPa) N standard penetration test (SPT) N* SPT - sample recovered Nc SPT with solid cone VS vane shear; peak/remoulded (kPa) R refusal HB hammer bouncing	soil symbol & soil description based on AS 1726:2017 moisture condition D dry M moist W wet Wp plastic limit WI liquid limit	consistency / relative density VS very soft S soft F firm St stiff VSt very stiff H hard Fb friable VL very loose L loose MD medium dense D dense VD very dense
--	--	--	---	--

CDF_0_9_07_LIBRARY.GLB rev:AU Log COF BOREHOLE: NON CORED 754-SYDGE206418-3.GPJ <<DrawingFile>> 27/03/2020 09:20

Engineering Log - Borehole

DRAFT

Borehole ID. **UG-BH-04**
 sheet: 3 of 14
 project no. **754-SYDGE206418-3**
 date started: **20 Feb 2020**
 date completed: **23 Feb 2020**
 logged by: **TBM**
 checked by: **PLV**

client: **EMM CONSULTING PTY LTD**
 principal: **Evolution Mining**
 project: **CGO UNDERGROUND DEVELOPMENT EIS**
 location: **COWAL GOLD OPERATIONS**

position: Not Specified surface elevation: Not Specified angle from horizontal: -90°
 drill model: Sandvik DE840, Truck mounted drilling fluid: PAK-R casing diameter: PVC150/PW

drilling information				material substance										
method & support	1 penetration	2 penetration	3 penetration	water	samples & field tests	RL (m)	depth (m)	graphic log	soil group symbol	material description	moisture condition	consistency / relative density	hand penetrometer (kPa)	structure and additional observations
				Not Observable			17.0			Gravelly CLAY: high plasticity, red/brown mottled pale grey and pale brown, gravel is fine to coarse grained, sub-angular, with fine to coarse grained sand and magnesium staining in veins/joints. <i>(continued)</i>				EXTREMELY WEATHERED ROCK Core Run (16.8-17.5 m): 100% recovery Core Run (17.5-18.0 m): 100% recovery
							18.0			Borehole UG-BH-04 continued as cored hole				
							19.0							
							20.0							
							21.0							
							22.0							
							23.0							

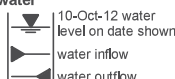
method AD auger drilling* AS auger screwing* HA hand auger W washbore * bit shown by suffix e.g. AD/T B blank bit T TC bit V V bit	support M mud N nil C casing penetration  water 	samples & field tests B bulk disturbed sample D disturbed sample E environmental sample SS split spoon sample U## undisturbed sample ##mm diameter HP hand penetrometer (kPa) N standard penetration test (SPT) N* SPT - sample recovered Nc SPT with solid cone VS vane shear; peak/remoulded (kPa) R refusal HB hammer bouncing	soil group symbol & soil description based on AS 1726:2017 moisture condition D dry M moist W wet Wp plastic limit WI liquid limit	consistency / relative density VS very soft S soft F firm St stiff VSt very stiff H hard Fb friable VL very loose L loose MD medium dense D dense VD very dense
--	--	--	---	--

CDF_0_9_07_LIBRARY.GLB rev:AU Log COF BOREHOLE: NON CORED 754-SYDGE206418-3.GPJ <<DrawingFile>> 27/03/2020 09:20

Engineering Log - Cored Borehole

client: **EMM CONSULTING PTY LTD**
principal: **Evolution Mining**
project: **CGO UNDERGROUND DEVELOPMENT EIS**
location: **COWAL GOLD OPERATIONS**

Borehole ID: **UG-BH-04**
sheet: 4 of 14
project no: **754-SYDGE206418-3**
date started: **20 Feb 2020**
date completed: **23 Feb 2020**
logged by: **TBM**
checked by: **PLV**

position: Not Specified surface elevation: Not Specified angle from horizontal: -90°
drill model: Sandvik DE840, Truck mounted drilling fluid: PAK-R casing diameter: PVC150/PW

drilling information		material substance				rock mass defects						
method & support	water	RL (m)	depth (m)	graphic log	material description ROCK TYPE: grain characteristics, colour, structure, minor components	weathering & alteration	estimated strength & Is50 X = axial O = diametral a = axial d = diametral	samples, field tests & Is(50) (MPa)	core run & RQD	defect spacing (mm)	additional observations and defect descriptions (type, inclination, planarity, roughness, coating, thickness, other)	
							VL L M H VH EH			30 100 300 1000 3000	particular	general
			17.0									
			18.0		started coring at 18.00m							
			18.0	X	ANDESITE: fine grained, red/brown and pale brown, porphyritic, heavily fractured along planes at 0-45°.	XW - HW					Due to drilling method and extensive weathering of rock, sample is highly fractured and defects are difficult to log. Only major/distinguishable defects will be logged until 54.5m	
			19.0	X							SM, 15°, Clay, 19 mm	
			19.0	X							SM, 20°, Clay, 15 mm	
			20.0	X							SM, 25°, Clay, 120 mm	
			21.0	X							SM, 15°, Clay, 28 mm	
			21.0	X							SM, 20°, Clay, 54 mm	
			22.0	X							SM, 30°, Clay, 26 mm	
			22.0	X							SM, 10°, Clay, 29 mm	
			22.0	X							SM, 40°, Clay, 21 mm	
			23.0	X							SM, 70°, Clay, 46 mm	

method & support AS auger screwing AD auger drilling CB claw or blade bit W washbore RR rock roller NMLCNMLC core (51.9 mm) NQ wireline core (47.6mm) HQ wireline core (63.5mm) PQ wireline core (85.0mm)	support C casing M mud N none water 10/10/12, water level on date shown water inflow complete drilling fluid loss partial drilling fluid loss water pressure test result (lugeons) for depth interval shown	graphic log / core recovery core recovered (graphic symbols indicate material) no core recovered core run & RQD barrel withdrawn RQD = Rock Quality Designation (%)	weathering & alteration* RS residual soil XW extremely weathered HW highly weathered MW moderately weathered SW slightly weathered FR fresh *W replaced with A for alteration strength VL very low L low M medium H high VH very high EH extremely high	defect type PT parting JT joint SS shear surface SZ shear zone CO contact CS crushed seam SM seam roughness VR very rough RO rough SO smooth POL polished SL slickensided	planarity PL planar CU curved UN undulating ST stepped IR irregular coating CN clean SN stained VN veneer CO coating
---	--	--	---	--	--

Engineering Log - Cored Borehole

Borehole ID. **UG-BH-04**
 sheet: 5 of 14
 project no. **754-SYDGE206418-3**
 date started: **20 Feb 2020**
 date completed: **23 Feb 2020**
 logged by: **TBM**
 checked by: **PLV**

client: **EMM CONSULTING PTY LTD**
 principal: **Evolution Mining**
 project: **CGO UNDERGROUND DEVELOPMENT EIS**
 location: **COWAL GOLD OPERATIONS**

position: Not Specified surface elevation: Not Specified angle from horizontal: -90°
 drill model: Sandvik DE840, Truck mounted drilling fluid: PAK-R casing diameter: PVC150/PW

drilling information		material substance				rock mass defects							
method & support	water	RL (m)	depth (m)	graphic log	material description ROCK TYPE: grain characteristics, colour, structure, minor components	weathering & alteration	estimated strength & Is50 X = axial O = diametral a = axial d = diametral	samples, field tests & Is(50) (MPa)	core run & RQD	defect spacing (mm)	additional observations and defect descriptions (type, inclination, planarity, roughness, coating, thickness, other)		
										30 100 300 1000 3000	particular	general	
			25.0		ANDESITE: fine grained, red/brown and pale brown, porphyritic, heavily fractured along planes at 0-45°. (continued)	XW - HW					JT, 45°, PL, SO, Fe SN		
			26.0									JT, 25°, PL, SO, Fe SN, Healed	
			27.0									JT, 45°, PL, SO, Fe SN, Healed	
			28.0									JT, 70°, PL, SO, Fe SN	
			29.0									JT, 50°, PL, SO, Fe SN	
			30.0										
			31.0										

CDF_0_9_07_LIBRARY.GLB rev:AU Log_COF_BOREHOLE: CORED 754-SYDGE206418-3.GPJ <<DrawingFile>> 27/03/2020 09:21

method & support AS auger screwing AD auger drilling CB claw or blade bit W washbore RR rock roller NMLCNMLC core (51.9 mm) NQ wireline core (47.6mm) HQ wireline core (63.5mm) PQ wireline core (85.0mm)	support C casing M mud N none water 10/10/12, water level on date shown water inflow complete drilling fluid loss partial drilling fluid loss water pressure test result (lugeons) for depth interval shown	graphic log / core recovery core recovered (graphic symbols indicate material) no core recovered core run & RQD barrel withdrawn RQD = Rock Quality Designation (%)	weathering & alteration* RS residual soil XW extremely weathered HW highly weathered MW moderately weathered SW slightly weathered FR fresh *W replaced with A for alteration strength VL very low L low M medium H high VH very high EH extremely high	defect type PT parting JT joint SS shear surface SZ shear zone CO contact CS crushed seam SM seam roughness VR very rough RO rough SO smooth POL polished SL slickensided	planarity PL planar CU curved UN undulating ST stepped IR irregular coating CN clean SN stained VN veneer CO coating
---	--	--	---	--	--

Engineering Log - Cored Borehole

Borehole ID: **UG-BH-04**
 sheet: 6 of 14
 project no: **754-SYDGE206418-3**
 date started: **20 Feb 2020**
 date completed: **23 Feb 2020**
 logged by: **TBM**
 checked by: **PLV**

client: **EMM CONSULTING PTY LTD**
 principal: **Evolution Mining**
 project: **CGO UNDERGROUND DEVELOPMENT EIS**
 location: **COWAL GOLD OPERATIONS**

position: Not Specified surface elevation: Not Specified angle from horizontal: -90°
 drill model: Sandvik DE840, Truck mounted drilling fluid: PAK-R casing diameter: PVC150/PW

drilling information		material substance				rock mass defects							
method & support	water	RL (m)	depth (m)	graphic log	material description ROCK TYPE: grain characteristics, colour, structure, minor components	weathering & alteration	estimated strength & Is50 X = axial O = diametral a = axial d = diametral	samples, field tests & Is(50) (MPa)	core run & RQD	defect spacing (mm)	additional observations and defect descriptions (type, inclination, planarity, roughness, coating, thickness, other)		
											particular	general	
			33.0		ANDESITE: fine grained, red/brown and pale brown, porphyritic, heavily fractured along planes at 0-45°. (continued)	XW - HW							
			34.0										
			35.0										
			36.0										
			37.0										
			38.0										
			39.0										

CDF_0_9_07_LIBRARY.GLB rev:AU Log COF BOREHOLE: CORED 754-SYDGE206418-3.GPJ <<DrawingFile>> 27/03/2020 09:21

method & support AS auger screwing AD auger drilling CB claw or blade bit W washbore RR rock roller NMLCNMLC core (51.9 mm) NQ wireline core (47.6mm) HQ wireline core (63.5mm) PQ wireline core (85.0mm)	support C casing M mud N none water 10/10/12, water level on date shown water inflow complete drilling fluid loss partial drilling fluid loss water pressure test result (lugeons) for depth interval shown	graphic log / core recovery core recovered (graphic symbols indicate material) no core recovered core run & RQD barrel withdrawn RQD = Rock Quality Designation (%)	weathering & alteration* RS residual soil XW extremely weathered HW highly weathered MW moderately weathered SW slightly weathered FR fresh *W replaced with A for alteration strength VL very low L low M medium H high VH very high EH extremely high	defect type PT parting JT joint SS shear surface SZ shear zone CO contact CS crushed seam SM seam roughness VR very rough RO rough SO smooth POL polished SL slickensided	planarity PL planar CU curved UN undulating ST stepped IR irregular coating CN clean SN stained VN veneer CO coating
---	--	--	---	--	--

Engineering Log - Cored Borehole

client: **EMM CONSULTING PTY LTD**
principal: **Evolution Mining**
project: **CGO UNDERGROUND DEVELOPMENT EIS**
location: **COWAL GOLD OPERATIONS**

Borehole ID: **UG-BH-04**
sheet: 7 of 14
project no: **754-SYDGE206418-3**
date started: **20 Feb 2020**
date completed: **23 Feb 2020**
logged by: **TBM**
checked by: **PLV**

position: Not Specified surface elevation: Not Specified angle from horizontal: -90°
drill model: Sandvik DE840, Truck mounted drilling fluid: PAK-R casing diameter: PVC150/PW

drilling information		material substance				rock mass defects					
method & support	water	RL (m)	depth (m)	graphic log	material description ROCK TYPE: grain characteristics, colour, structure, minor components	weathering & alteration	estimated strength & Is50 X = axial O = diametral a = axial d = diametral	samples, field tests & Is(50) (MPa)	defect spacing (mm)	additional observations and defect descriptions (type, inclination, planarity, roughness, coating, thickness, other)	
										particular	general
			41.0		ANDESITE: fine grained, red/brown and pale brown, porphyritic, heavily fractured along planes at 0-45°. (continued)	XW - HW				SM, 0°, Clay, 800 mm	
			42.0		CORE LOSS 0.3M.						
			42.0		ANDESITE: fine grained, red/brown and pale brown, porphyritic, heavily fractured along planes at 0-45°.	XW - MW					
			43.0							SM, 30°, Clay, 50 mm	
			44.0								
			45.0		45.20 m: pale green/pale brown altered rock appearing, particularly around joints/defects					SM, Clay, 28 mm	
			46.0								
			47.0		46.60 m: becoming purple brown and pale brown, with green/pale brown alteration found near joints/defects					JT, 45°, IR, SO, SN, and altered PB JT, 70°, IR, SO, SN	

method & support AS auger screwing AD auger drilling CB claw or blade bit W washbore RR rock roller NMLCNMLC core (51.9 mm) NQ wireline core (47.6mm) HQ wireline core (63.5mm) PQ wireline core (85.0mm)	support C casing M mud N none water 10/10/12, water level on date shown water inflow complete drilling fluid loss partial drilling fluid loss water pressure test result (lugeons) for depth interval shown	graphic log / core recovery core recovered (graphic symbols indicate material) no core recovered core run & RQD barrel withdrawn RQD = Rock Quality Designation (%)	weathering & alteration* RS residual soil XW extremely weathered HW highly weathered MW moderately weathered SW slightly weathered FR fresh *W replaced with A for alteration strength VL very low L low M medium H high VH very high EH extremely high	defect type PT parting JT joint SS shear surface SZ shear zone CO contact CS crushed seam SM seam roughness VR very rough RO rough SO smooth POL polished SL slickensided	planarity PL planar CU curved UN undulating ST stepped IR irregular coating CN clean SN stained VN veneer CO coating
---	--	--	---	--	--

Engineering Log - Cored Borehole

Borehole ID. **UG-BH-04**
 sheet: 8 of 14
 project no. **754-SYDGE206418-3**
 date started: **20 Feb 2020**
 date completed: **23 Feb 2020**
 logged by: **TBM**
 checked by: **PLV**

client: **EMM CONSULTING PTY LTD**
 principal: **Evolution Mining**
 project: **CGO UNDERGROUND DEVELOPMENT EIS**
 location: **COWAL GOLD OPERATIONS**

position: Not Specified surface elevation: Not Specified angle from horizontal: -90°
 drill model: Sandvik DE840, Truck mounted drilling fluid: PAK-R casing diameter: PVC150/PW

drilling information		material substance				rock mass defects							
method & support	water	RL (m)	depth (m)	graphic log	material description ROCK TYPE: grain characteristics, colour, structure, minor components	weathering & alteration	estimated strength & Is(50) X = axial O = diametral a = axial d = diametral	samples, field tests & Is(50) (MPa)	core run & RQD	defect spacing (mm)	additional observations and defect descriptions (type, inclination, planarity, roughness, coating, thickness, other)		
										30 100 300 1000 3000	particular	general	
			49.0	X	ANDESITE: fine grained, red/brown and pale brown, porphyritic, heavily fractured along planes at 0-45°. (continued)	XW - MW					SM, Clay, 60 mm		
			50.0	X								SM, Clay, 40 mm	
			51.0	X								SM, Clay, 50 mm	
			52.0	X								JT, 50°, PL, RO, Sandy clay CO - SN	
			53.0	X								JT, 60°, PL, RO, Fe SN, Healed JT, 15°, UN, RO, Fe SN, Healed JT, 50°, IR, RO, Fe SN, Healed JT, 30°, PL, SO, Fe SN	
			54.0	X								JT, 45°, PL, SO, Fe SN	
			55.0	X								JT, 50°, PL, SO, SN	
				X								SM, 10 - 15°, Clay, 22 mm	
				X								JT, 50°, PL, SO, Fe SN	
				X									

method & support AS auger screwing AD auger drilling CB claw or blade bit W washbore RR rock roller NMLCNMLC core (51.9 mm) NQ wireline core (47.6mm) HQ wireline core (63.5mm) PQ wireline core (85.0mm)	support C casing M mud N none water 10/10/12, water level on date shown water inflow complete drilling fluid loss partial drilling fluid loss water pressure test result (lugeons) for depth interval shown	graphic log / core recovery core recovered (graphic symbols indicate material) no core recovered core run & RQD barrel withdrawn RQD = Rock Quality Designation (%)	weathering & alteration* RS residual soil XW extremely weathered HW highly weathered MW moderately weathered SW slightly weathered FR fresh *W replaced with A for alteration strength VL very low L low M medium H high VH very high EH extremely high	defect type PT parting JT joint SS shear surface SZ shear zone CO contact CS crushed seam SM seam roughness VR very rough RO rough SO smooth POL polished SL slickensided	planarity PL planar CU curved UN undulating ST stepped IR irregular coating CN clean SN stained VN veneer CO coating
---	--	--	---	--	--

Engineering Log - Cored Borehole

Borehole ID. **UG-BH-04**
 sheet: 9 of 14
 project no. **754-SYDGE206418-3**
 date started: **20 Feb 2020**
 date completed: **23 Feb 2020**
 logged by: **TBM**
 checked by: **PLV**

client: **EMM CONSULTING PTY LTD**
 principal: **Evolution Mining**
 project: **CGO UNDERGROUND DEVELOPMENT EIS**
 location: **COWAL GOLD OPERATIONS**

position: Not Specified surface elevation: Not Specified angle from horizontal: -90°
 drill model: Sandvik DE840, Truck mounted drilling fluid: PAK-R casing diameter: PVC150/PW

drilling information		material substance				rock mass defects					
method & support	water	RL (m)	depth (m)	graphic log	material description ROCK TYPE: grain characteristics, colour, structure, minor components	weathering & alteration	estimated strength & Is(50) X = axial O = diametral a = axial d = diametral	samples, field tests & Is(50) (MPa)	defect spacing (mm)	additional observations and defect descriptions (type, inclination, planarity, roughness, coating, thickness, other)	
										particular	general
			57.0		ANDESITE: fine grained, red/brown and pale brown, porphyritic, heavily fractured along planes at 0-45°. (continued) 61.20 m: veins of quartz/calcite appearing up to 5mm thick	XW - HW				Extremely weathered rock	
			58.0							JT, 5°, UN, SO, Fe SN Vein quartz, 5°, UN, 8 mm	
			59.0							JT, 65°, PL, SO, Fe SN SM, Sandy clay, 100 mm	
			60.0				HW			JT, 45°, PL, SO, Fe SN JT, 50°, PL, SO, Fe SN JT, 20°, UN, SO, Fe SN JT, 45°, PL, RO, Fe SN	
			61.0							JT, 20°, PL, RO, Fe SN JT, 20°, PL, RO, Fe SN JT, 10°, PL, RO, Fe SN - Clay CO	
			62.0				MW			JT, 30°, IR, RO, Fe SN	
			63.0							JT, 25°, PL, RO, Fe SN	

CDF_0_9_07_LIBRARY.GLB rev.AU Log_COF_BOREHOLE: CORED 754-SYDGE206418-3.GPJ <<DrawingFile>> 27/03/2020 09:21

method & support AS auger screwing AD auger drilling CB claw or blade bit W washbore RR rock roller NMLCNMLC core (51.9 mm) NQ wireline core (47.6mm) HQ wireline core (63.5mm) PQ wireline core (85.0mm)	support C casing M mud N none water 10/10/12, water level on date shown water inflow complete drilling fluid loss partial drilling fluid loss water pressure test result (lugeons) for depth interval shown	graphic log / core recovery core recovered (graphic symbols indicate material) no core recovered core run & RQD barrel withdrawn RQD = Rock Quality Designation (%)	weathering & alteration* RS residual soil XW extremely weathered HW highly weathered MW moderately weathered SW slightly weathered FR fresh *W replaced with A for alteration strength VL very low L low M medium H high VH very high EH extremely high	defect type PT parting JT joint SS shear surface SZ shear zone CO contact CS crushed seam SM seam roughness VR very rough RO rough SO smooth POL polished SL slickensided	planarity PL planar CU curved UN undulating ST stepped IR irregular coating CN clean SN stained VN veneer CO coating
---	--	--	---	--	--

Engineering Log - Cored Borehole

client: **EMM CONSULTING PTY LTD**
principal: **Evolution Mining**
project: **CGO UNDERGROUND DEVELOPMENT EIS**
location: **COWAL GOLD OPERATIONS**

Borehole ID: **UG-BH-04**
sheet: 10 of 14
project no: **754-SYDGE206418-3**
date started: **20 Feb 2020**
date completed: **23 Feb 2020**
logged by: **TBM**
checked by: **PLV**

position: Not Specified surface elevation: Not Specified angle from horizontal: -90°
drill model: Sandvik DE840, Truck mounted drilling fluid: PAK-R casing diameter: PVC150/PW

drilling information		material substance				rock mass defects					
method & support	water	RL (m)	depth (m)	graphic log	material description ROCK TYPE: grain characteristics, colour, structure, minor components	weathering & alteration	estimated strength & Is(50) X = axial O = diametral a = axial d = diametral	samples, field tests & Is(50) (MPa)	defect spacing (mm)	additional observations and defect descriptions (type, inclination, planarity, roughness, coating, thickness, other)	
										particular	general
HC	Not Observable		65.0		ANDESITE: fine grained, red/brown and pale brown, porphyritic, heavily fractured along planes at 0-45°. <i>(continued)</i>	MW				JT, 70°, PL, SO, Fe SN JT, 70°, PL, SO, Fe SN	
			66.0		65.00 m: becoming pale brown with red/brown and grey sections					JT, 40°, PL, SO, Fe SN JT, 55°, PL, SO, Fe SN	
			67.0			SW - MW				JT, 70°, PL, SO, Fe SN JT, 45°, PL, SO, Fe SN	
			68.0							JT, 80°, UN, SO, Fe SN JT, 60°, UN, SO, Fe SN	
			69.0							JT, 45°, PL, SO, Fe SN JT, 50°, PL, SO, Fe SN Hight weathered rock/fractured zone	
			70.0							JT, 10°, IR, SO, Fe SN - Clay CO JT, 60°, PL, SO, Fe SN - Clay CO	
			71.0							JT, 45°, IR, SO, Fe SN SM, 15°, Clay, 7 mm	

method & support AS auger screwing AD auger drilling CB claw or blade bit W washbore RR rock roller NMLCNMLC core (51.9 mm) NQ wireline core (47.6mm) HQ wireline core (63.5mm) PQ wireline core (85.0mm)	support C casing M mud N none water 10/10/12, water level on date shown water inflow complete drilling fluid loss partial drilling fluid loss water pressure test result (lugeons) for depth interval shown	graphic log / core recovery core recovered (graphic symbols indicate material) no core recovered core run & RQD barrel withdrawn RQD = Rock Quality Designation (%)	weathering & alteration* RS residual soil XW extremely weathered HW highly weathered MW moderately weathered SW slightly weathered FR fresh *W replaced with A for alteration strength VL very low L low M medium H high VH very high EH extremely high	defect type PT parting JT joint SS shear surface SZ shear zone CO contact CS crushed seam SM seam roughness VR very rough RO rough SO smooth POL polished SL slickensided	planarity PL planar CU curved UN undulating ST stepped IR irregular coating CN clean SN stained VN veneer CO coating
---	--	--	---	--	--

Engineering Log - Cored Borehole

client: **EMM CONSULTING PTY LTD**
principal: **Evolution Mining**
project: **CGO UNDERGROUND DEVELOPMENT EIS**
location: **COWAL GOLD OPERATIONS**

Borehole ID: **UG-BH-04**
sheet: 11 of 14
project no. **754-SYDGE206418-3**
date started: **20 Feb 2020**
date completed: **23 Feb 2020**
logged by: **TBM**
checked by: **PLV**

position: Not Specified surface elevation: Not Specified angle from horizontal: -90°
drill model: Sandvik DE840, Truck mounted drilling fluid: PAK-R casing diameter: PVC150/PW

drilling information		material substance				rock mass defects					
method & support	water	RL (m)	depth (m)	graphic log	material description ROCK TYPE: grain characteristics, colour, structure, minor components	weathering & alteration	estimated strength & Is(50) X = axial O = diametral a = axial d = diametral	samples, field tests & Is(50) (MPa)	defect spacing (mm)	additional observations and defect descriptions (type, inclination, planarity, roughness, coating, thickness, other)	
										particular	general
			73.0		ANDESITE: fine grained, red/brown and pale brown, porphyritic, heavily fractured along planes at 0-45°. <i>(continued)</i>	SW - MW				JT, 10°, PL, SO, Fe SN	
			74.0	74.00 m: becoming grey, manganese stained fracture planes every 5-10mm becoming less obvious						JT, 50°, PL, SO, Fe SN - Clay CO JT, 50°, PL, SO, Fe SN - Clay CO JT, 50°, PL, SO, Fe SN - Clay CO JT, 50°, PL, SO, Fe SN - Clay CO JT, 50°, PL, SO, Fe SN - Clay CO JT, 70°, PL, SO, Clay CO JT, 70°, PL, SO, Fe SN Vein quartz, 45°, 20 mm JT, 10°, UN, SO, Clay CO	
			75.0		75.44 m: trace pyrite crystals up to 1mm wide appearing, particularly amongst quartz veins 75.73 m: manganese stained fracture planes no longer visible	SW				JT, 65°, UN, SO, Fe CO JT, 55°, PL, SO, Fe CO JT, 15°, PL, SO, Fe CO JT, 25°, PL, SO, Fe SN - Clay CO JT, 15°, PL, SO, Clay VN, Healed JT, 45°, IR, SO, Sandy clay VN JT, 45°, PL, SO, Fe SN	
			76.0							JT, 20°, PL, SO, Fe SN JT, 70°, UN, SO, Fe SN JT, 50°, UN, SO, Fe SN	
			77.0		79.45 m: becoming grey, with sporadic green/pale brown alteration near select joints	FR				JT, 30°, PL, SO, Fe SN	
			78.0							JT, 65°, PL, SO, Calcite VN Vein quartz, 30°, PL, 4 mm	
			79.0							JT, 85°, PL, SO, CN JT, 35°, PL, SO, CN JT, 70-85°, IR, SO, CN JT, 45°, IR, SO, CN JT, 65°, PL, SO, Healed	

method & support AS auger screwing AD auger drilling CB claw or blade bit W washbore RR rock roller NMLCNMLC core (51.9 mm) NQ wireline core (47.6mm) HQ wireline core (63.5mm) PQ wireline core (85.0mm)	support C casing M mud N none water 10/10/12, water level on date shown water inflow complete drilling fluid loss partial drilling fluid loss water pressure test result (lugeons) for depth interval shown	graphic log / core recovery core recovered (graphic symbols indicate material) no core recovered core run & RQD barrel withdrawn RQD = Rock Quality Designation (%)	weathering & alteration* RS residual soil XW extremely weathered HW highly weathered MW moderately weathered SW slightly weathered FR fresh *W replaced with A for alteration strength VL very low L low M medium H high VH very high EH extremely high	defect type PT parting JT joint SS shear surface SZ shear zone CO contact CS crushed seam SM seam roughness VR very rough RO rough SO smooth POL polished SL slickensided planarity PL planar CU curved UN undulating ST stepped IR Irregular coating CN clean SN stained VN veneer CO coating
---	--	--	---	--

Engineering Log - Cored Borehole

Borehole ID. **UG-BH-04**
 sheet: 12 of 14
 project no. **754-SYDGE206418-3**
 date started: **20 Feb 2020**
 date completed: **23 Feb 2020**
 logged by: **TBM**
 checked by: **PLV**

client: **EMM CONSULTING PTY LTD**
 principal: **Evolution Mining**
 project: **CGO UNDERGROUND DEVELOPMENT EIS**
 location: **COWAL GOLD OPERATIONS**

position: Not Specified surface elevation: Not Specified angle from horizontal: -90°
 drill model: Sandvik DE840, Truck mounted drilling fluid: PAK-R casing diameter: PVC150/PW

drilling information		material substance				rock mass defects					
method & support	water	RL (m)	depth (m)	graphic log	material description ROCK TYPE: grain characteristics, colour, structure, minor components	weathering & alteration	estimated strength & Is(50) X = axial O = diametral a = axial d = diametral	samples, field tests & Is(50) (MPa)	defect spacing (mm)	additional observations and defect descriptions (type, inclination, planarity, roughness, coating, thickness, other)	
								core run & RQD	particular		
			81.0		ANDESITE: fine grained, grey, porphyritic, with quartz and calcite veins 0-90° up to 5mm thick. 80.20 m: becoming grey, with no alteration observed 84.24 m: pyrite vein approximately 8mm thick, 50°	FR				JT, 15°, PL, SO, Clay VN, Healed JT, 80°, UN, SO, CN JT, 60°, PL, SO, Clay CO JT, 60°, PL, SO, Clay CO JT, 90 - 80°, UN, SO, Calcite VN JT, 45°, PL, SO, Calcite VN JT, 10°, PL, SO, Calcite VN JT, 30°, PL, SO, Calcite VN JT, 30°, IR, SO, Calcite VN JT, 40°, PL, SO, Calcite VN JT, 30°, PL, SO, Calcite VN JT, 50°, PL, SO, CN	
			82.0								
			83.0								
			84.0								
			85.0								
			86.0								
			87.0								

method & support AS auger screwing AD auger drilling CB claw or blade bit W washbore RR rock roller NMLCNMLC core (51.9 mm) NQ wireline core (47.6mm) HQ wireline core (63.5mm) PQ wireline core (85.0mm)	support C casing M mud N none water 10/10/12, water level on date shown water inflow complete drilling fluid loss partial drilling fluid loss water pressure test result (lugeons) for depth interval shown	graphic log / core recovery core recovered (graphic symbols indicate material) no core recovered core run & RQD barrel withdrawn RQD = Rock Quality Designation (%)	weathering & alteration* RS residual soil XW extremely weathered HW highly weathered MW moderately weathered SW slightly weathered FR fresh *W replaced with A for alteration strength VL very low L low M medium H high VH very high EH extremely high	defect type PT parting JT joint SS shear surface SZ shear zone CO contact CS crushed seam SM seam roughness VR very rough RO rough SO smooth POL polished SL slickensided	planarity PL planar CU curved UN undulating ST stepped IR irregular coating CN clean SN stained VN veneer CO coating
---	--	--	---	--	--

Engineering Log - Cored Borehole

DRAFT

Borehole ID. **UG-BH-04**
sheet: 13 of 14
project no. **754-SYDGE206418-3**
date started: **20 Feb 2020**
date completed: **23 Feb 2020**
logged by: **TBM**
checked by: **PLV**

client: **EMM CONSULTING PTY LTD**
principal: **Evolution Mining**
project: **CGO UNDERGROUND DEVELOPMENT EIS**
location: **COWAL GOLD OPERATIONS**

position: Not Specified surface elevation: Not Specified angle from horizontal: -90°
drill model: Sandvik DE840, Truck mounted drilling fluid: PAK-R casing diameter: PVC150/PW

drilling information		material substance				rock mass defects						
method & support	water	RL (m)	depth (m)	graphic log	material description ROCK TYPE: grain characteristics, colour, structure, minor components	weathering & alteration	estimated strength & Is50 X = axial O = diametral a = axial d = diametral	samples, field tests & Is(50) (MPa)	core run & RQD	defect spacing (mm)	additional observations and defect descriptions (type, inclination, planarity, roughness, coating, thickness, other)	
							VL L M H VH EH			30 100 300 1000 3000	particular	general
			89.0		ANDESITE: fine grained, grey, porphyritic, with quartz and calcite veins 0-90° up to 5mm thick. (continued)	FR					JT, 40°, PL, SO, CAIcrite VN	
			90.0								JT, 40°, PL, SO, CAIcrite VN	
			91.0									
			92.0									
			93.0								JT, 40°, PL, SO, Clay CO	
			94.0									
			95.0									

CDF_0_9_07_LIBRARY.GLB rev:AU Log_COF_BOREHOLE: CORED 754-SYDGE206418-3.GPJ <<DrawingFile>> 27/03/2020 09:21

method & support AS auger screwing AD auger drilling CB claw or blade bit W washbore RR rock roller NMLCNMLC core (51.9 mm) NQ wireline core (47.6mm) HQ wireline core (63.5mm) PQ wireline core (85.0mm)	support C casing M mud N none water 10/10/12, water level on date shown water inflow complete drilling fluid loss partial drilling fluid loss water pressure test result (lugeons) for depth interval shown	graphic log / core recovery core recovered (graphic symbols indicate material) no core recovered core run & RQD barrel withdrawn RQD = Rock Quality Designation (%)	weathering & alteration* RS residual soil XW extremely weathered HW highly weathered MW moderately weathered SW slightly weathered FR fresh *W replaced with A for alteration strength VL very low L low M medium H high VH very high EH extremely high	defect type PT parting JT joint SS shear surface SZ shear zone CO contact CS crushed seam SM seam roughness VR very rough RO rough SO smooth POL polished SL slickensided	planarity PL planar CU curved UN undulating ST stepped IR irregular coating CN clean SN stained VN veneer CO coating
---	--	--	---	--	--

Engineering Log - Cored Borehole

Borehole ID. **UG-BH-04**
 sheet: 14 of 14
 project no. **754-SYDGE206418-3**
 date started: **20 Feb 2020**
 date completed: **23 Feb 2020**
 logged by: **TBM**
 checked by: **PLV**

client: **EMM CONSULTING PTY LTD**
 principal: **Evolution Mining**
 project: **CGO UNDERGROUND DEVELOPMENT EIS**
 location: **COWAL GOLD OPERATIONS**



position: Not Specified surface elevation: Not Specified angle from horizontal: -90°
 drill model: Sandvik DE840, Truck mounted drilling fluid: PAK-R casing diameter: PVC150/PW

drilling information		material substance				rock mass defects					
method & support	water	RL (m)	depth (m)	graphic log	material description ROCK TYPE: grain characteristics, colour, structure, minor components	weathering & alteration	estimated strength & Is(50) X = axial O = diametral a = axial d = diametral	samples, field tests & Is(50) (MPa)	core run & RQD	defect spacing (mm)	additional observations and defect descriptions (type, inclination, planarity, roughness, coating, thickness, other)
			97.0		ANDESITE: fine grained, grey, porphyritic, with quartz and calcite veins 0-90° up to 5mm thick. <i>(continued)</i> quartz/calcite veins increasing in range of thickness up to 15mm	FR				JT, 70°, PL, SO, Clay CO Vein quartz, 62 mm	particular general
		98.0									
		99.0									
		100.0									
		101.0									
		102.0									
		103.0			Borehole UG-BH-04 terminated at 102.20 m Target depth						

CDF_0_9_07_LIBRARY.GLB rev:AU Log COF BOREHOLE: CORED 754-SYDGE206418-3.GPJ <<DrawingFile>> 27/03/2020 09:21

method & support AS auger screwing AD auger drilling CB claw or blade bit W washbore RR rock roller NMLCNMLC core (51.9 mm) NQ wireline core (47.6mm) HQ wireline core (63.5mm) PQ wireline core (85.0mm)	support C casing M mud N none water 10/10/12, water level on date shown water inflow complete drilling fluid loss partial drilling fluid loss water pressure test result (lugeons) for depth interval shown	graphic log / core recovery core recovered (graphic symbols indicate material) no core recovered core run & RQD barrel withdrawn RQD = Rock Quality Designation (%)	weathering & alteration* RS residual soil XW extremely weathered HW highly weathered MW moderately weathered SW slightly weathered FR fresh *W replaced with A for alteration strength VL very low L low M medium H high VH very high EH extremely high	defect type PT parting JT joint SS shear surface SZ shear zone CO contact CS crushed seam SM seam roughness VR very rough RO rough SO smooth POL polished SL slickensided	planarity PL planar CU curved UN undulating ST stepped IR irregular coating CN clean SN stained VN veneer CO coating
---	--	--	---	--	--



UG-BH-04 5.10 - 8.90 m

drawn	TBM		client:	EMM CONSULTING PTY LTD		
approved	AO		project:	CGO UNDERGROUND DEVELOPMENT EIS COWAL GOLD OPERATIONS		
date	23/03/2020		title:	CORE PHOTOGRAPH UG-BH-04		
scale	N.T.S.		project no:	754-SYDGE206418-3	fig no:	FIGURE 1
original size	A4		rev:	A		



UG-BH-04 8.90 - 12.30 m

drawn	TBM		client:	EMM CONSULTING PTY LTD		
approved	AO		project:	CGO UNDERGROUND DEVELOPMENT EIS COWAL GOLD OPERATIONS		
date	23/03/2020		title:	CORE PHOTOGRAPH UG-BH-04		
scale	N.T.S.		project no:	754-SYDGE206418-3	fig no:	FIGURE 2
original size	A4				rev:	A



UG-BH-04 12.30 - 16.00 m

drawn	TBM		client: EMM CONSULTING PTY LTD		
approved	AO		project: CGO UNDERGROUND DEVELOPMENT EIS COWAL GOLD OPERATIONS		
date	23/03/2020		title: CORE PHOTOGRAPH UG-BH-04		
scale	N.T.S.		project no: 754-SYDGE206418-3	fig no: FIGURE 3	rev: A
original size	A4				



UG-BH-04 16.00 - 19.40 m

drawn	TBM		client:	EMM CONSULTING PTY LTD		
approved	AO		project:	CGO UNDERGROUND DEVELOPMENT EIS COWAL GOLD OPERATIONS		
date	23/03/2020		title:	CORE PHOTOGRAPH UG-BH-04		
scale	N.T.S.		project no:	754-SYDGE206418-3	fig no:	FIGURE 4
original size	A4				rev:	A

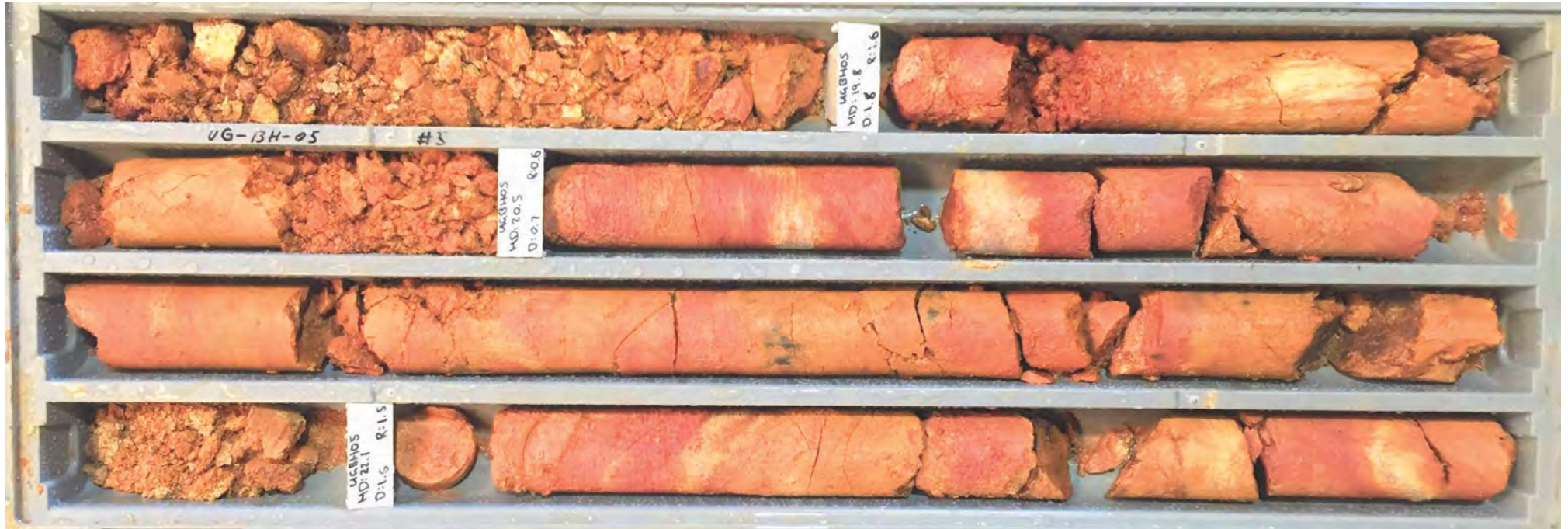

UG-BH-04 19.40 - 22.80 m

drawn	TBM		client: EMM CONSULTING PTY LTD		
approved	AO		project: CGO UNDERGROUND DEVELOPMENT EIS COWAL GOLD OPERATIONS		
date	23/03/2020		title: CORE PHOTOGRAPH UG-BH-04		
scale	N.T.S.		project no: 754-SYDGE206418-3	fig no: FIGURE 5	rev: A
original size	A4				



UG-BH-04 22.80 - 26.20 m

drawn	TBM		client:	EMM CONSULTING PTY LTD		
approved	AO		project:	CGO UNDERGROUND DEVELOPMENT EIS COWAL GOLD OPERATIONS		
date	23/03/2020		title:	CORE PHOTOGRAPH UG-BH-04		
scale	N.T.S.		project no:	754-SYDGE206418-3	fig no:	FIGURE 6
original size	A4		rev:	A		



UG-BH-04 26.20 - 29.70 m

drawn	TBM		client:	EMM CONSULTING PTY LTD		
approved	AO		project:	CGO UNDERGROUND DEVELOPMENT EIS COWAL GOLD OPERATIONS		
date	23/03/2020		title:	CORE PHOTOGRAPH UG-BH-04		
scale	N.T.S.		project no:	754-SYDGE206418-3	fig no:	FIGURE 7
original size	A4		rev:	A		



UG-BH-04 29.70 - 32.80 m

drawn	TBM		client:	EMM CONSULTING PTY LTD		
approved	AO		project:	CGO UNDERGROUND DEVELOPMENT EIS COWAL GOLD OPERATIONS		
date	23/03/2020		title:	CORE PHOTOGRAPH UG-BH-04		
scale	N.T.S.		project no:	754-SYDGE206418-3	fig no:	FIGURE 8
original size	A4				rev:	A



UG-BH-04 32.80 - 36.45 m

drawn	TBM		client:	EMM CONSULTING PTY LTD		
approved	AO		project:	CGO UNDERGROUND DEVELOPMENT EIS COWAL GOLD OPERATIONS		
date	23/03/2020		title:	CORE PHOTOGRAPH UG-BH-04		
scale	N.T.S.		project no:	754-SYDGE206418-3	fig no:	FIGURE 9
original size	A4		rev:	A		



UG-BH-04 36.45 - 39.60 m

drawn	TBM		client:	EMM CONSULTING PTY LTD				
approved	AO		project:	CGO UNDERGROUND DEVELOPMENT EIS COWAL GOLD OPERATIONS				
date	23/03/2020		title:	CORE PHOTOGRAPH UG-BH-04				
scale	N.T.S.		project no:	754-SYDGE206418-3	fig no:	FIGURE 10	rev:	A
original size	A4							



UG-BH-04 39.60 - 43.00 m

drawn	TBM		client:	EMM CONSULTING PTY LTD		
approved	AO		project:	CGO UNDERGROUND DEVELOPMENT EIS COWAL GOLD OPERATIONS		
date	23/03/2020		title:	CORE PHOTOGRAPH UG-BH-04		
scale	N.T.S.		project no:	754-SYDGE206418-3	fig no:	FIGURE 11
original size	A4				rev:	A



UG-BH-04 43.00 - 46.70 m

drawn	TBM		client:	EMM CONSULTING PTY LTD		
approved	AO		project:	CGO UNDERGROUND DEVELOPMENT EIS COWAL GOLD OPERATIONS		
date	23/03/2020		title:	CORE PHOTOGRAPH UG-BH-04		
scale	N.T.S.		project no:	754-SYDGE206418-3	fig no:	FIGURE 12
original size	A4		rev:	A		



UG-BH-04 46.70 - 49.90 m

drawn	TBM	 A TETRA TECH COMPANY	client:	EMM CONSULTING PTY LTD		
approved	AO		project:	CGO UNDERGROUND DEVELOPMENT EIS COWAL GOLD OPERATIONS		
date	23/03/2020		title:	CORE PHOTOGRAPH UG-BH-04		
scale	N.T.S.		project no:	754-SYDGE206418-3	fig no:	FIGURE 13
original size	A4				rev:	A



UG-BH-04 49.90 - 53.50 m

drawn	TBM		client: EMM CONSULTING PTY LTD		
approved	AO		project: CGO UNDERGROUND DEVELOPMENT EIS COWAL GOLD OPERATIONS		
date	23/03/2020		title: CORE PHOTOGRAPH UG-BH-04		
scale	N.T.S.		project no: 754-SYDGE206418-3	fig no: FIGURE 14	rev: A
original size	A4				



UG-BH-04 53.50 - 56.40 m

drawn	TBM		client: EMM CONSULTING PTY LTD	
approved	AO		project: CGO UNDERGROUND DEVELOPMENT EIS COWAL GOLD OPERATIONS	
date	23/03/2020		title: CORE PHOTOGRAPH UG-BH-04	
scale	N.T.S.			
original size	A4		project no: 754-SYDGE206418-3	fig no: FIGURE 15



UG-BH-04 56.40 - 60.10 m

drawn	TBM		client:	EMM CONSULTING PTY LTD		
approved	AO		project:	CGO UNDERGROUND DEVELOPMENT EIS COWAL GOLD OPERATIONS		
date	23/03/2020		title:	CORE PHOTOGRAPH UG-BH-04		
scale	N.T.S.		project no:	754-SYDGE206418-3	fig no:	FIGURE 16
original size	A4		rev:	A		



UG-BH-04 60.10 - 63.60 m

drawn	TBM		client:	EMM CONSULTING PTY LTD		
approved	AO		project:	CGO UNDERGROUND DEVELOPMENT EIS COWAL GOLD OPERATIONS		
date	23/03/2020		title:	CORE PHOTOGRAPH UG-BH-04		
scale	N.T.S.		project no:	754-SYDGE206418-3	fig no:	FIGURE 17
original size	A4				rev:	A



UG-BH-04 63.60 - 67.00 m

drawn	TBM		client:	EMM CONSULTING PTY LTD		
approved	AO		project:	CGO UNDERGROUND DEVELOPMENT EIS COWAL GOLD OPERATIONS		
date	23/03/2020		title:	CORE PHOTOGRAPH UG-BH-04		
scale	N.T.S.		project no:	754-SYDGE206418-3	fig no:	FIGURE 18
original size	A4				rev:	A

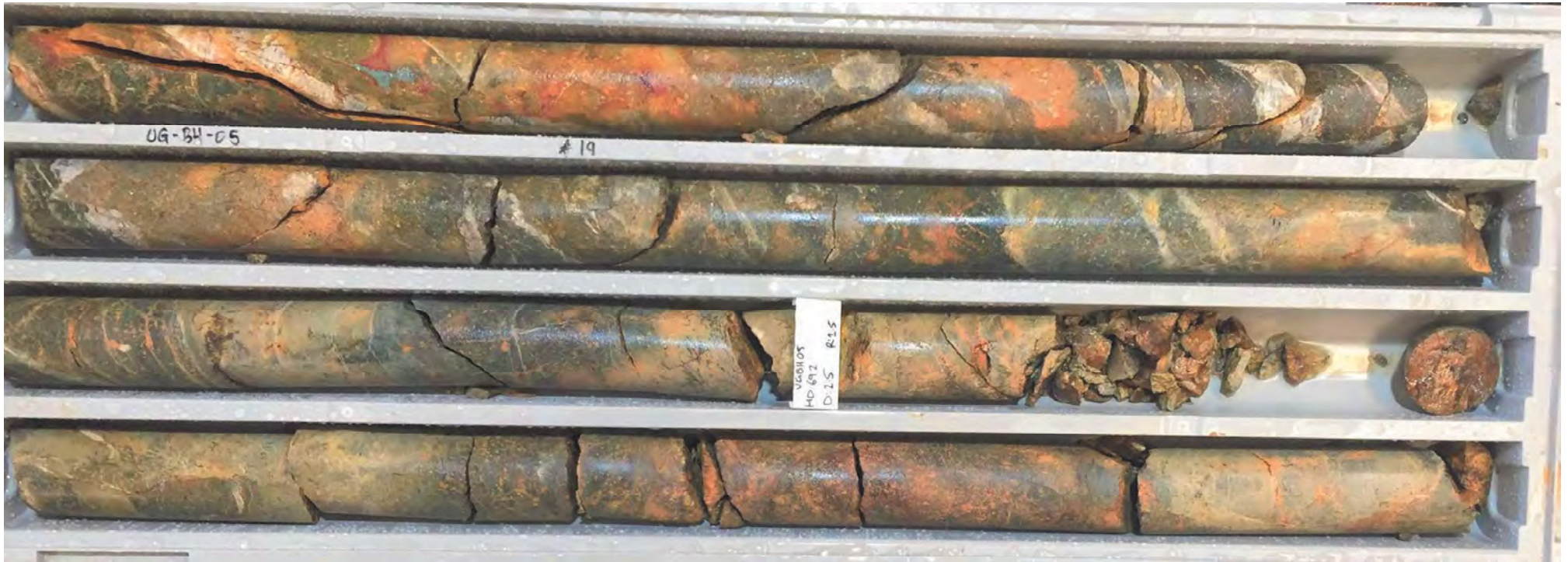

UG-BH-04 67.00 - 70.65 m

drawn	TBM		client:	EMM CONSULTING PTY LTD		
approved	AO		project:	CGO UNDERGROUND DEVELOPMENT EIS COWAL GOLD OPERATIONS		
date	23/03/2020		title:	CORE PHOTOGRAPH UG-BH-04		
scale	N.T.S.		project no:	754-SYDGE206418-3	fig no:	FIGURE 19
original size	A4				rev:	A

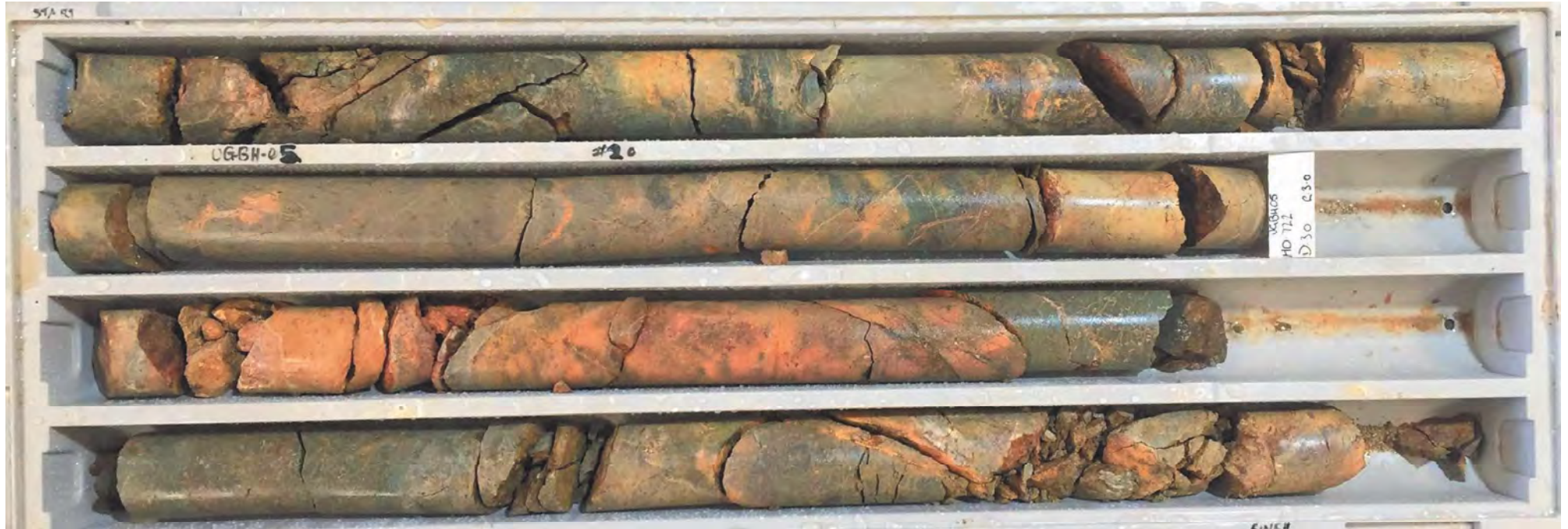

UG-BH-04 70.65 - 74.70 m

drawn	TBM		client:	EMM CONSULTING PTY LTD		
approved	AO		project:	CGO UNDERGROUND DEVELOPMENT EIS COWAL GOLD OPERATIONS		
date	23/03/2020		title:	CORE PHOTOGRAPH UG-BH-04		
scale	N.T.S.		project no:	754-SYDGE206418-3	fig no:	FIGURE 20
original size	A4		rev:	A		

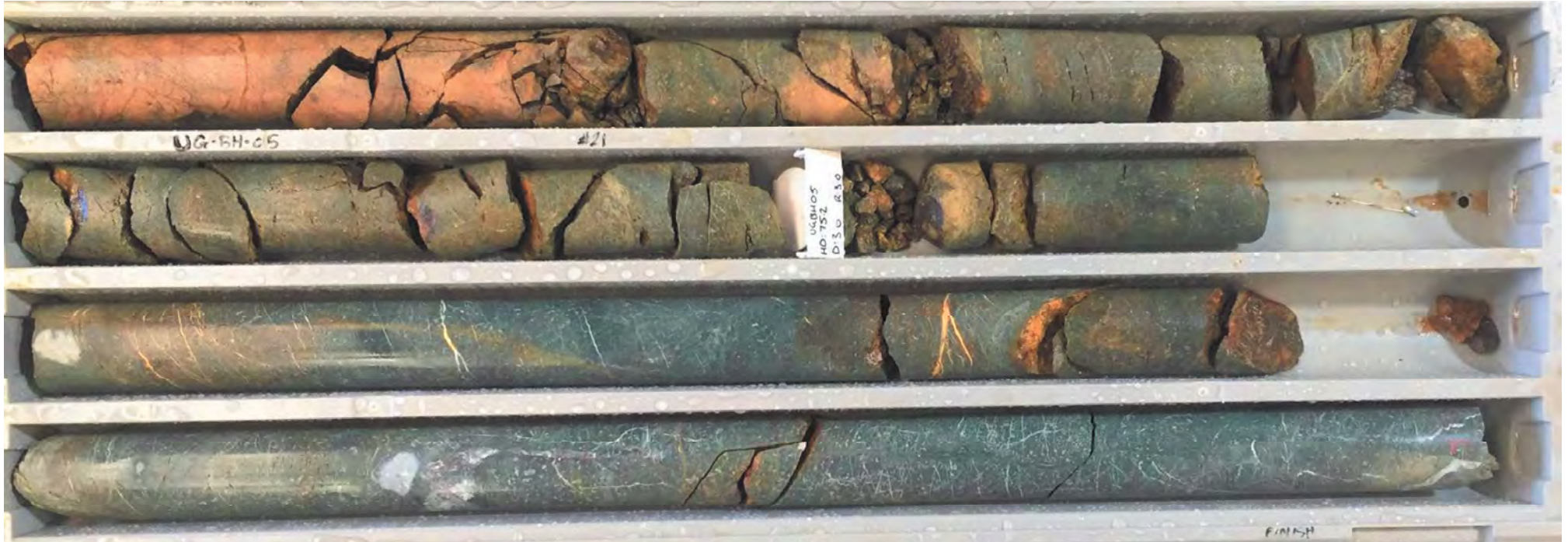

UG-BH-04 74.70 - 77.20 m

drawn	TBM		client:	EMM CONSULTING PTY LTD		
approved	AO		project:	CGO UNDERGROUND DEVELOPMENT EIS COWAL GOLD OPERATIONS		
date	23/03/2020		title:	CORE PHOTOGRAPH UG-BH-04		
scale	N.T.S.		project no:	754-SYDGE206418-3	fig no:	FIGURE 21
original size	A4		rev:	A		

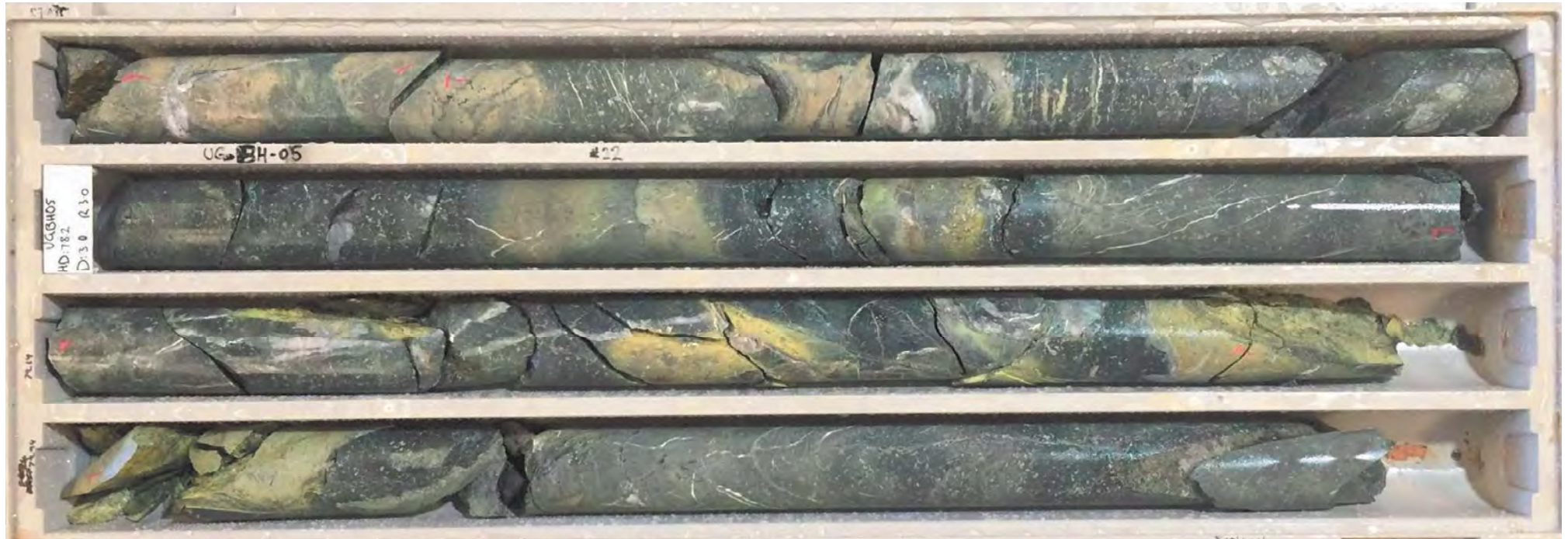

UG-BH-04 77.20 - 80.70 m

drawn	TBM		client:	EMM CONSULTING PTY LTD		
approved	AO		project:	CGO UNDERGROUND DEVELOPMENT EIS COWAL GOLD OPERATIONS		
date	23/03/2020		title:	CORE PHOTOGRAPH UG-BH-04		
scale	N.T.S.		project no:	754-SYDGE206418-3	fig no:	FIGURE 22
original size	A4				rev:	A



UG-BH-04 80.70 - 84.20 m

drawn	TBM		client:	EMM CONSULTING PTY LTD		
approved	AO		project:	CGO UNDERGROUND DEVELOPMENT EIS COWAL GOLD OPERATIONS		
date	23/03/2020		title:	CORE PHOTOGRAPH UG-BH-04		
scale	N.T.S.		project no:	754-SYDGE206418-3	fig no:	FIGURE 23
original size	A4		rev:	A		



UG-BH-04 84.20 - 87.75 m

drawn	TBM		client: EMM CONSULTING PTY LTD		
approved	AO		project: CGO UNDERGROUND DEVELOPMENT EIS COWAL GOLD OPERATIONS		
date	23/03/2020		title: CORE PHOTOGRAPH UG-BH-04		
scale	N.T.S.		project no: 754-SYDGE206418-3	fig no: FIGURE 24	rev: A
original size	A4				

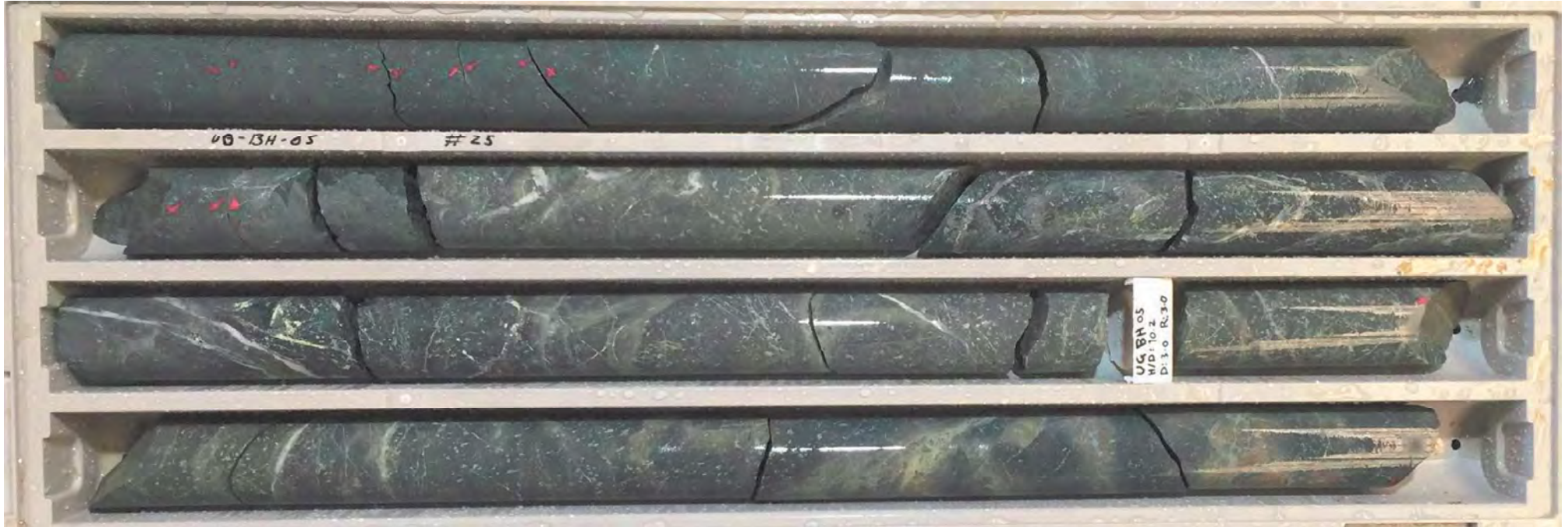

UG-BH-04 87.75 - 91.15 m

drawn	TBM		client:	EMM CONSULTING PTY LTD				
approved	AO		project:	CGO UNDERGROUND DEVELOPMENT EIS COWAL GOLD OPERATIONS				
date	23/03/2020		title:	CORE PHOTOGRAPH UG-BH-04				
scale	N.T.S.		project no:	754-SYDGE206418-3	fig no:	FIGURE 25	rev:	A
original size	A4							



UG-BH-04 91.15 - 94.00 m

drawn	TBM		client:	EMM CONSULTING PTY LTD		
approved	AO		project:	CGO UNDERGROUND DEVELOPMENT EIS COWAL GOLD OPERATIONS		
date	23/03/2020		title:	CORE PHOTOGRAPH UG-BH-04		
scale	N.T.S.		project no:	754-SYDGE206418-3	fig no:	FIGURE 26
original size	A4				rev:	A

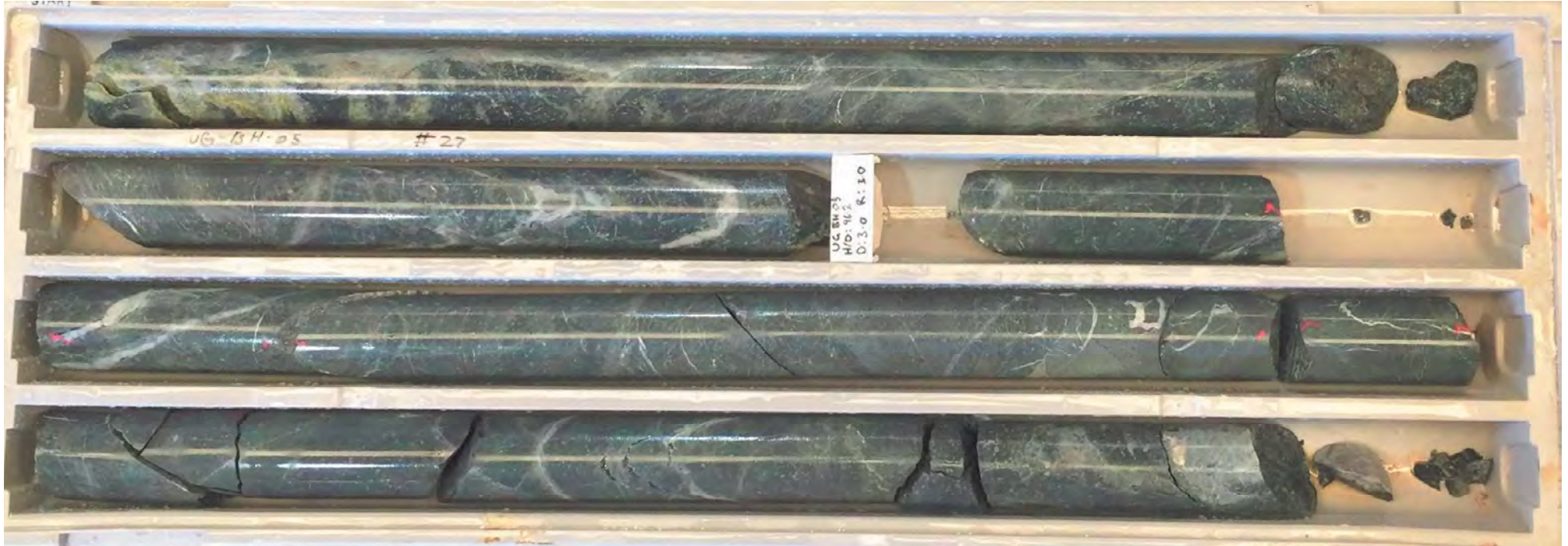

UG-BH-04 94.00 - 98.00 m

drawn	TBM		client: EMM CONSULTING PTY LTD		
approved	AO		project: CGO UNDERGROUND DEVELOPMENT EIS COWAL GOLD OPERATIONS		
date	23/03/2020		title: CORE PHOTOGRAPH UG-BH-04		
scale	N.T.S.		project no: 754-SYDGE206418-3	fig no: FIGURE 27	rev: A
original size	A4				

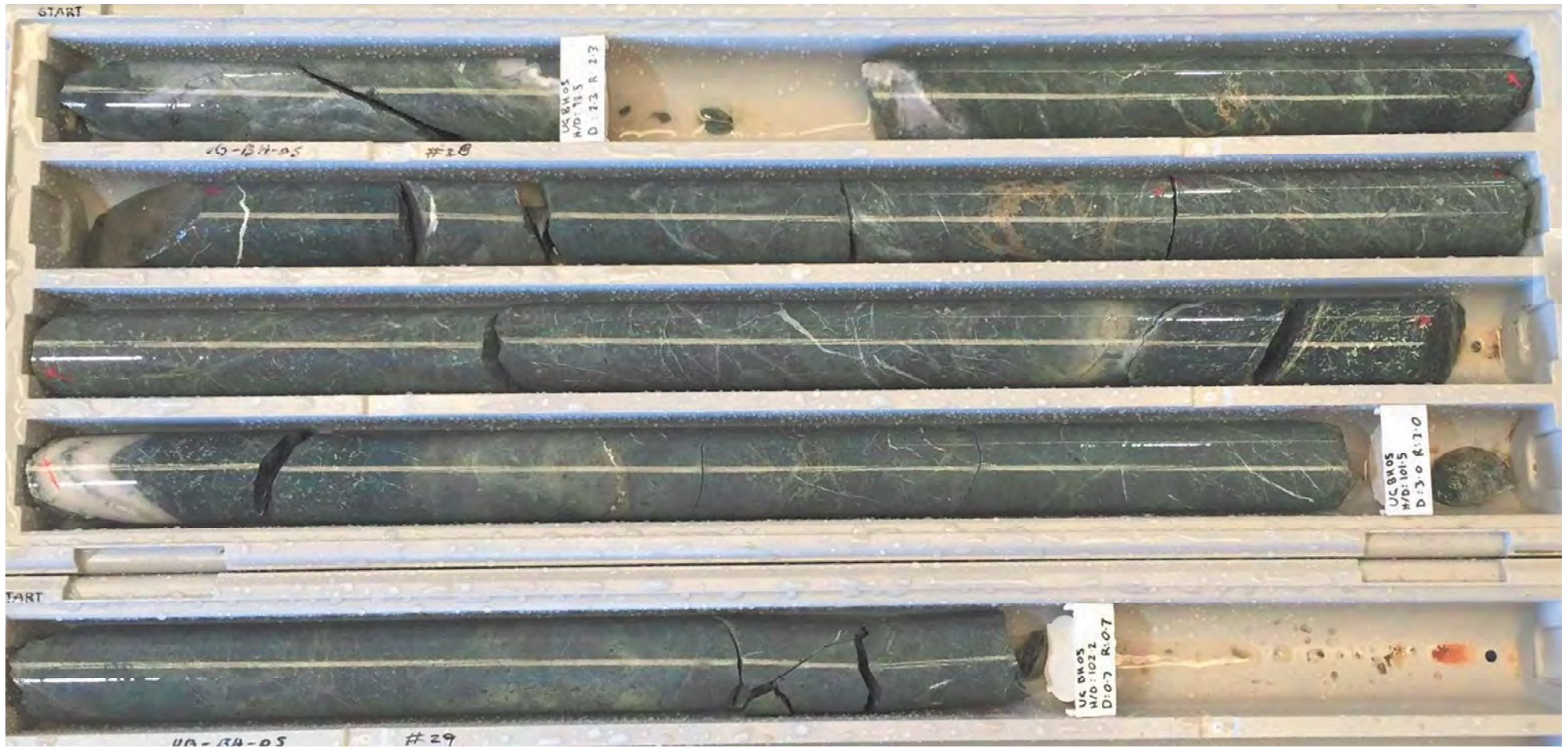

UG-BH-04 98.00 - 102.00 m

drawn	TBM		client: EMM CONSULTING PTY LTD		
approved	AO		project: CGO UNDERGROUND DEVELOPMENT EIS COWAL GOLD OPERATIONS		
date	23/03/2020		title: CORE PHOTOGRAPH UG-BH-04		
scale	N.T.S.		project no: 754-SYDGE206418-3	fig no: FIGURE 28	rev: A
original size	A4				

Appendix B – Natural gamma logging

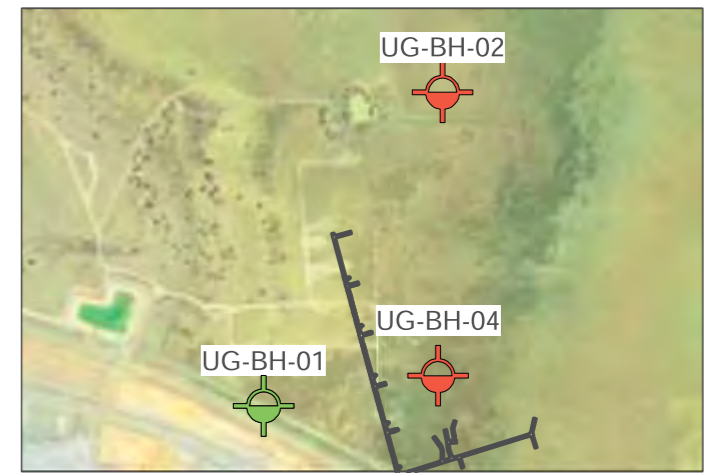
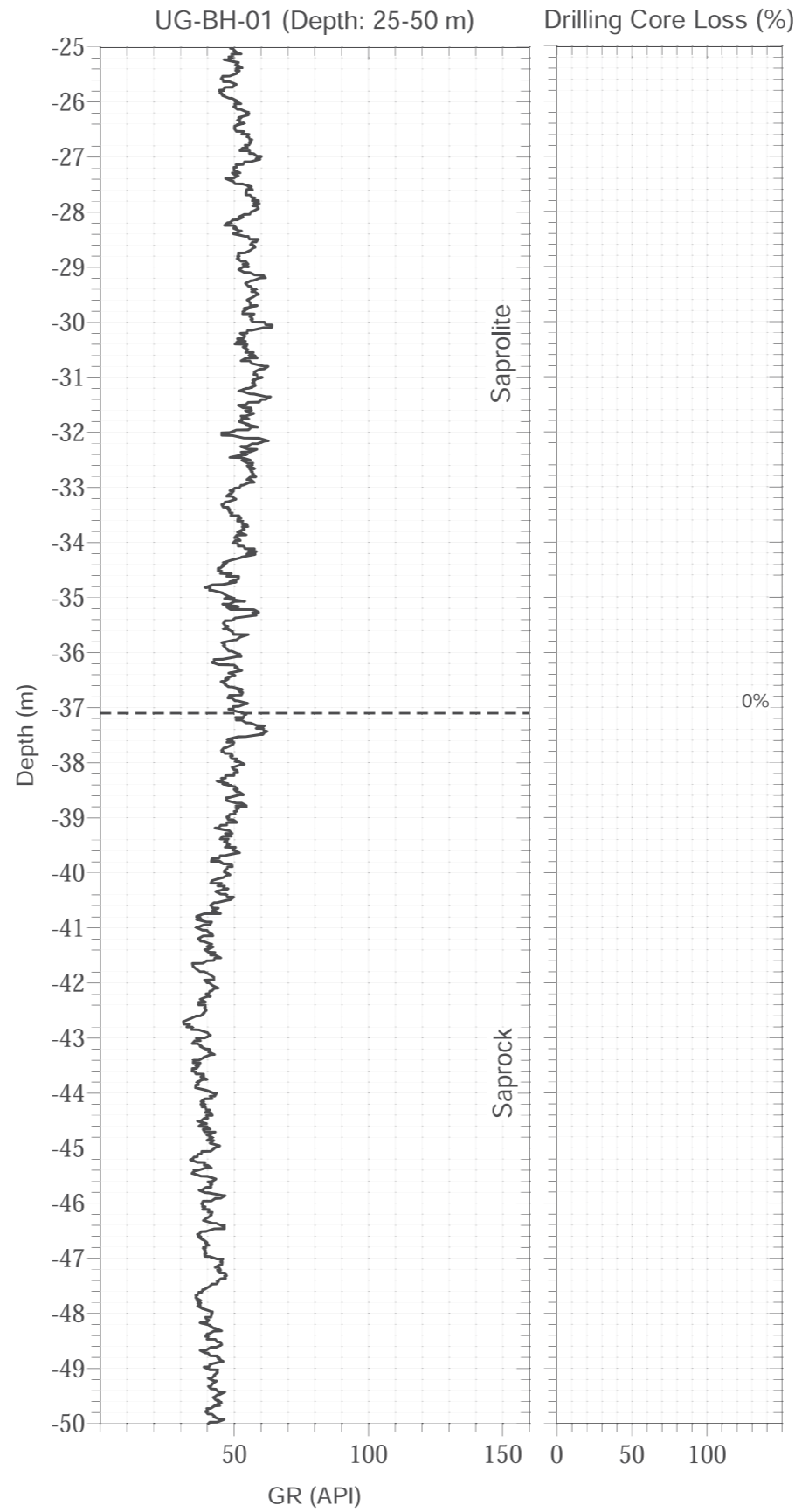
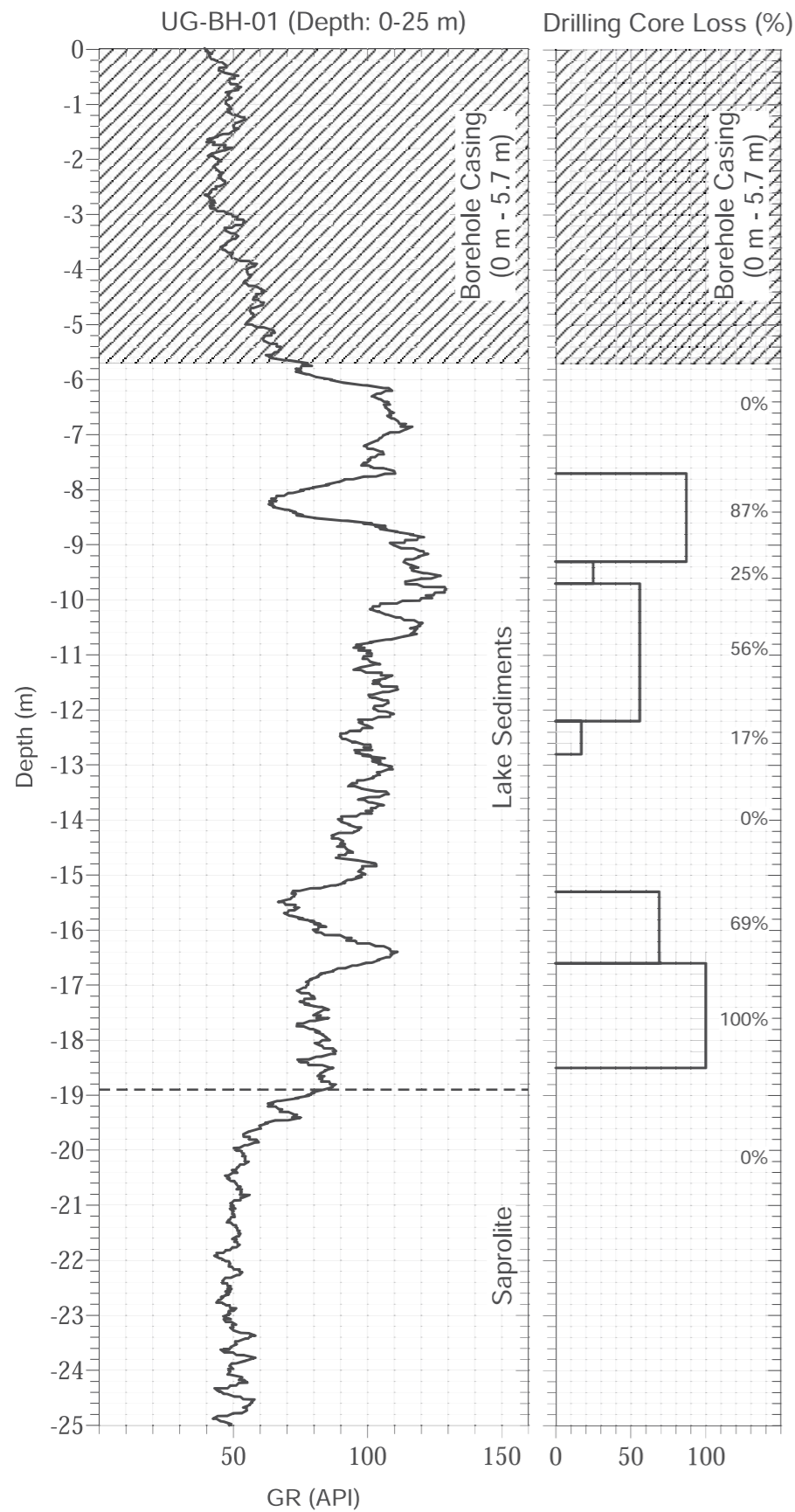

LEGEND

- Presented Borehole (Coffey)
- Boreholes (Coffey)
- Exploration Decline

Well Name:	UG-BH-01
Easting:	537751.6
Northing:	6278843.8
Location:	Cowal Gold Mine
Operator:	BS
Log Measured From:	Ground Level

GEODETIC PARAMETERS

Geodetic Datum:	MGA1994
Coordinate System:	MAP GRID of AUSTRALIA 1994
Projection:	Universal Transverse Mercator (UTM) Zone 55
Semi Major Axis:	6378137.0000m
Inverse Flattening (1/f):	298.25722210
Central Meridian:	147°00'00 East
Reference Latitude:	00°00'00 North
Scale Factor at CM:	0.9996
False Easting:	500,000m
False Northing:	10,000,000m

no.	description	drawn	approved	date
01	FINAL	BS	SS	17 / 03 / 2020

drawn	BS
approved	SS
date	17 / 03 / 2020
scale	NTS
original size	A3



client:	EMM CONSULTING PTY LTD		
project:	CGO UNDERGROUND DEVELOPMENT EIS		
title:	NATURAL GAMMA RAY PROFILING: UG-BH-01		
project no:	figure no:	rev:	
SYDGE206418-3	FIGURE B1	01	

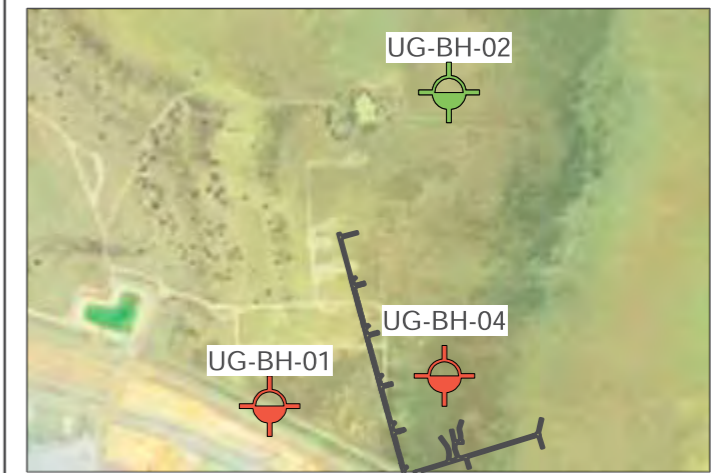
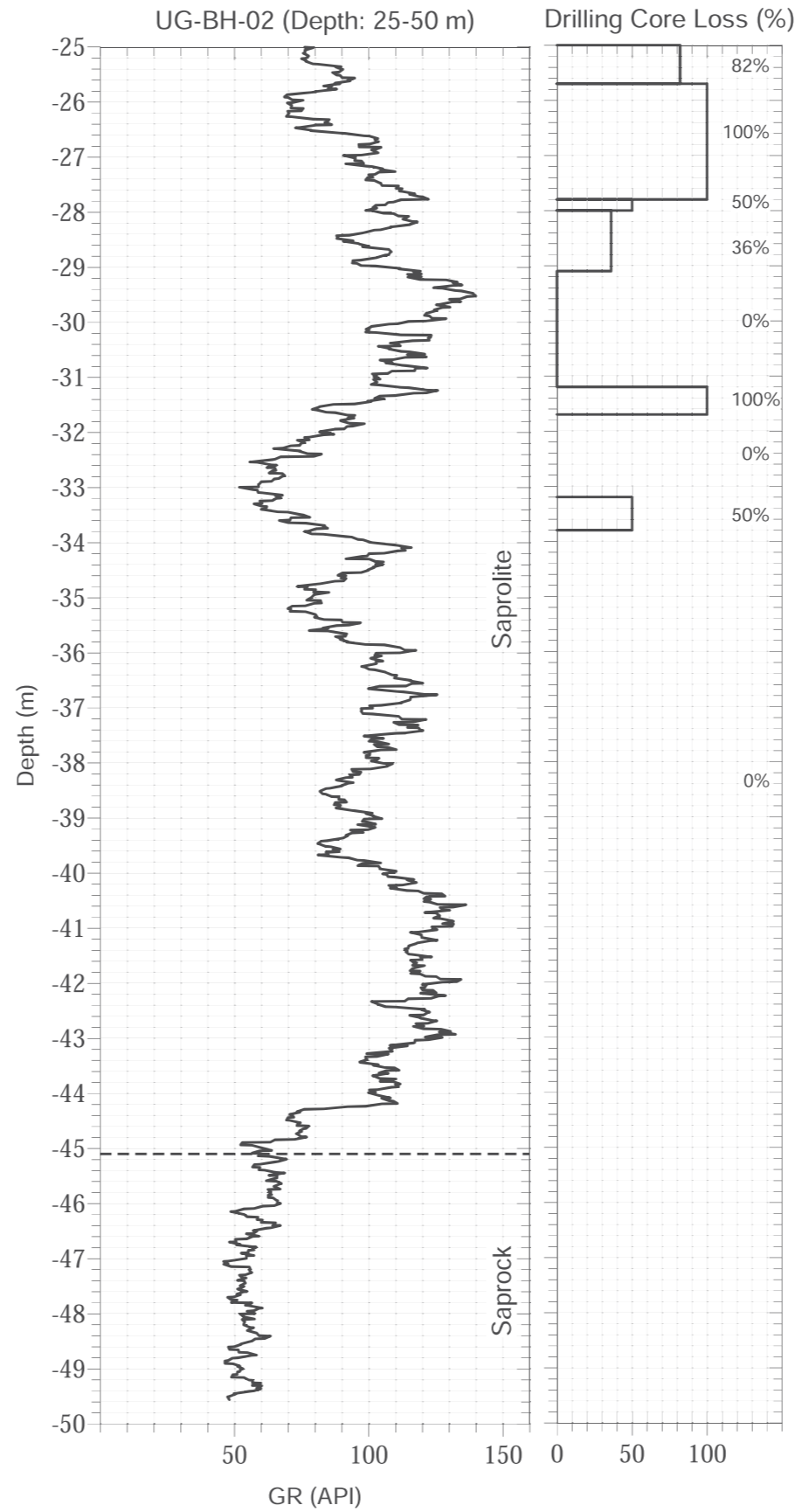
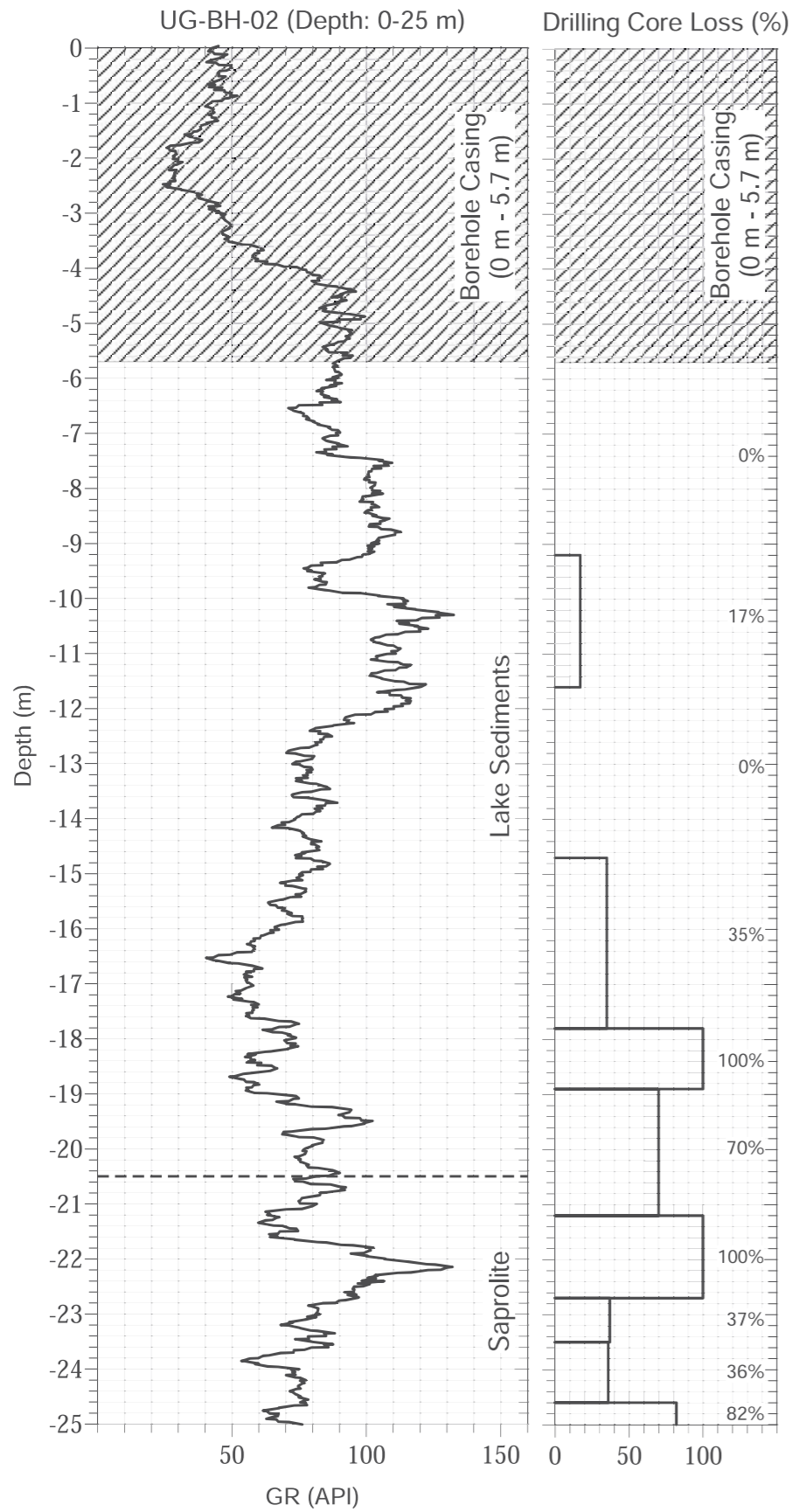

LEGEND

- Presented Borehole (Coffey)
- Boreholes (Coffey)
- Exploration Decline

Well Name:	UG-BH-02
Easting:	537751.6
Northing:	6278843.8
Location:	Cowal Gold Mine
Operator:	TM
Log Measured From:	Ground Level

GEODETIC PARAMETERS

Geodetic Datum:	MGA1994
Coordinate System:	MAP GRID of AUSTRALIA 1994
Projection:	Universal Transverse Mercator (UTM) Zone 55
Semi Major Axis:	6378137.0000m
Inverse Flattening (1/f):	298.25722210
Central Meridian:	147°00'00 East
Reference Latitude:	00°00'00 North
Scale Factor at CM:	0.9996
False Easting:	500,000m
False Northing:	10,000,000m

revision	no.	description	drawn	approved	date
	01	FINAL	BS	SS	17 / 03 / 2020

drawn	BS
approved	SS
date	17 / 03 / 2020
scale	NTS
original size	A3



client:	EMM CONSULTING PTY LTD		
project:	CGO UNDERGROUND DEVELOPMENT EIS		
title:	NATURAL GAMMA RAY PROFILING: UG-BH-02		
project no:	figure no:	rev:	
SYDGE206418-3	FIGURE B2	01	

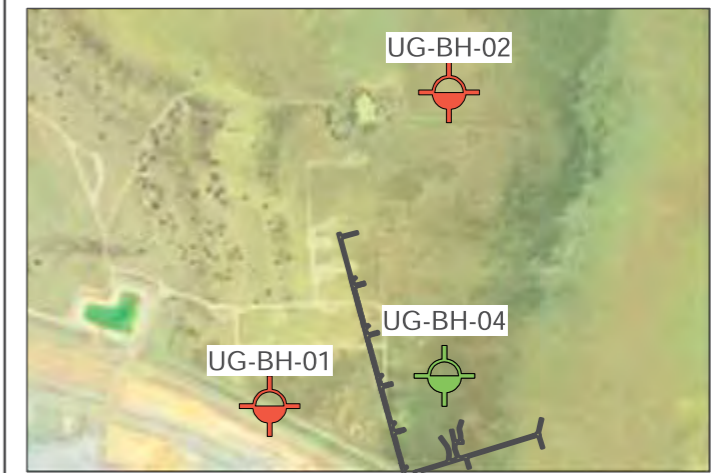
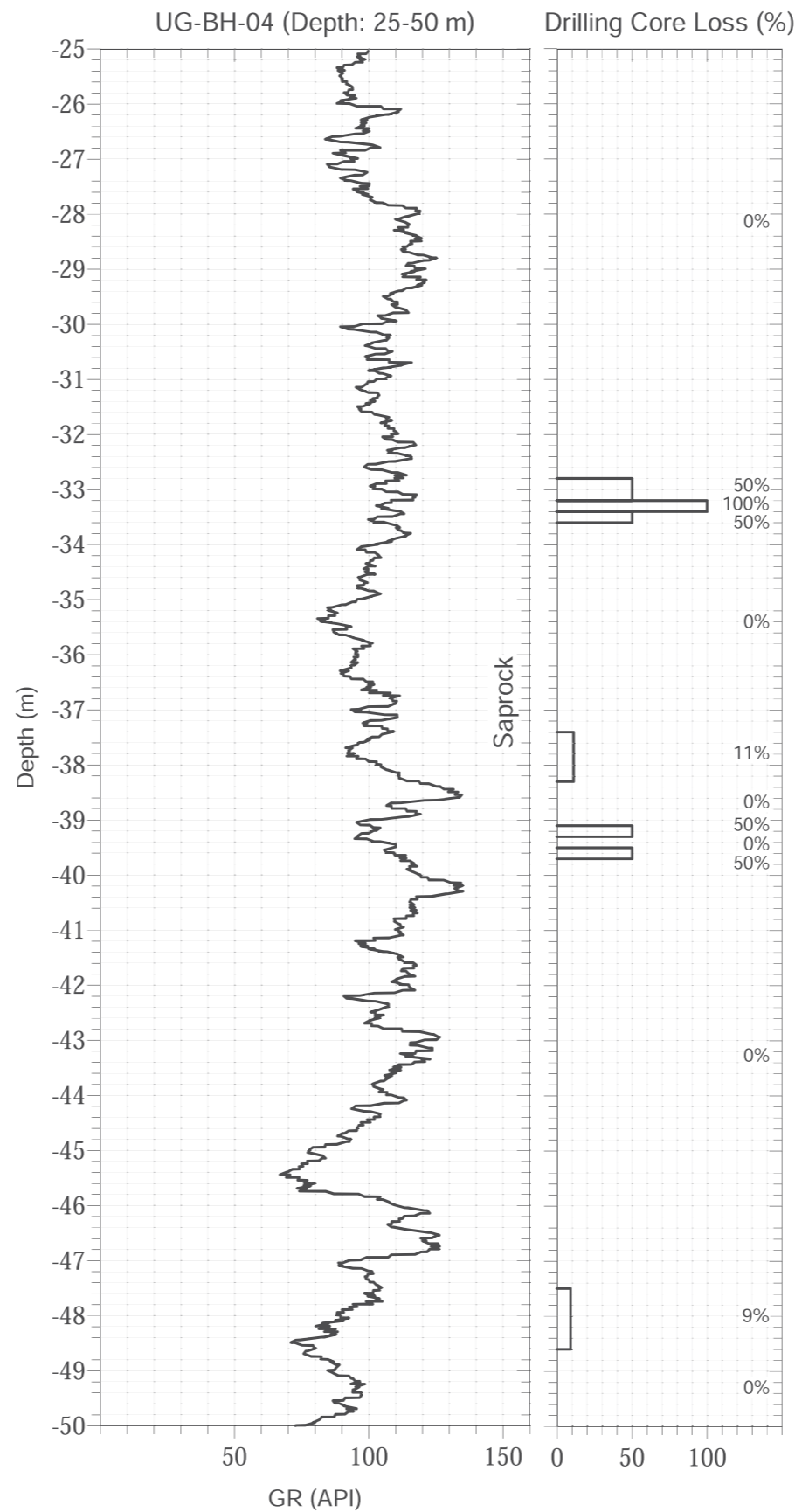
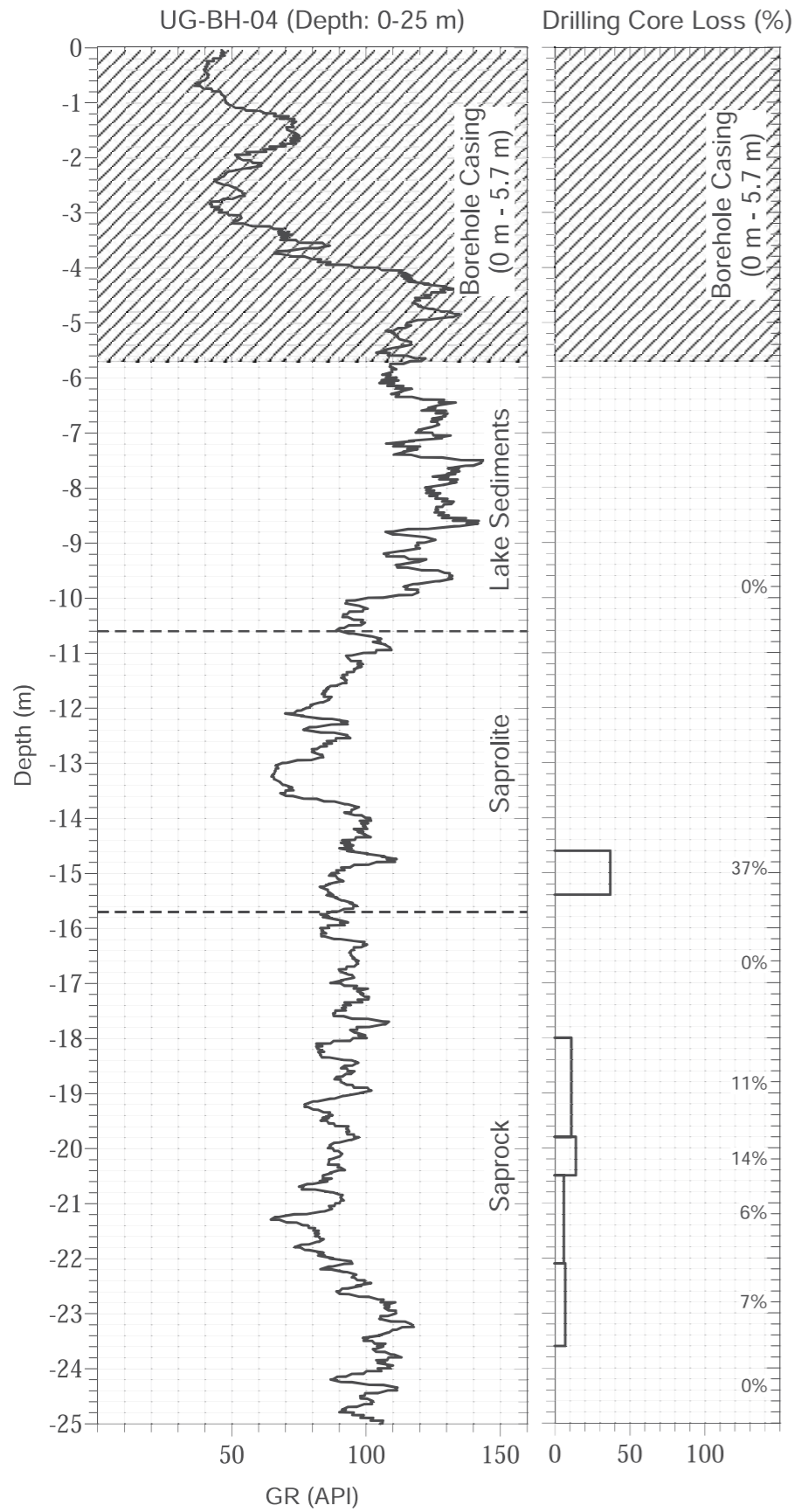

LEGEND

- Presented Borehole (Coffey)
- Boreholes (Coffey)
- Exploration Decline

Well Name:	UG-BH-04
Easting:	538169
Northing:	6278916
Location:	Cowal Gold Mine
Operator:	TM
Log Measured From:	Ground Level

GEODETIC PARAMETERS

Geodetic Datum:	MGA1994
Coordinate System:	MAP GRID of AUSTRALIA 1994
Projection:	Universal Transverse Mercator (UTM) Zone 55
Semi Major Axis:	6378137.0000m
Inverse Flattening (1/f):	298.25722210
Central Meridian:	147°00'00 East
Reference Latitude:	00°00'00 North
Scale Factor at CM:	0.9996
False Easting:	500,000m
False Northing:	10,000,000m

revision	no.	description	drawn	approved	date
	01	FINAL	BS	SS	17 / 03 / 2020

drawn	BS
approved	SS
date	17 / 03 / 2020
scale	NTS
original size	A3



client:	EMM CONSULTING PTY LTD		
project:	CGO UNDERGROUND DEVELOPMENT EIS		
title:	NATURAL GAMMA RAY PROFILING: UG-BH-04		
project no:	SYDGE206418-3	figure no:	FIGURE B3
		rev:	01

Appendix C – Packer test results

Borehole Water Pressure Test

Client **EMM CONSULTING PTY LTD**
Principal **Evolution Mining**
Project **CGO UNDERGROUND DEVELOPMENT EIS**
Location **North east of open pit outside lake bund**

Borehole **UG-BH-02**
Depth Interval **97.00-103.00 m**
Job No. **SYDGE206418-3**
Test date **6-2-2020**
Interpreted by **AO**
Checked **RJB**

Test Details	Packer type	Pneumatic	Borehole diam.	96 mm
	Type of pump	Drill rig	Borehole inclination	90 degrees
	Pressure gauge	Accu-Drive DD504N28-150D	Test interval length	6.00 m

time interval (min)	gauge pressure (kPa)	water loss (L)	flow rate (L/min)	pressure correction (kPa)	water loss rate (L/min/m)	corrected pressure (kPa)
1	150	0.1	0.14	0	0.02	150
1	150	0.1	0.08	0	0.01	150
1	150	0.1	0.08	0	0.01	150
1	150	0.1	0.10	0	0.02	150
1	150	0.1	0.06	0	0.01	150
5	150	0.2	0.05	0	0.01	150
1	250	0.1	0.12	0	0.02	250
1	250	0.1	0.09	0	0.02	250
1	250	0.1	0.10	0	0.02	250
1	250	0.1	0.09	0	0.02	250
1	250	0.1	0.06	0	0.01	250
5	250	0.4	0.07	0	0.01	250
1	350	0.1	0.12	0	0.02	350
1	350	0.1	0.08	0	0.01	350
1	350	0.1	0.09	0	0.02	350
1	350	0.1	0.08	0	0.01	350
1	350	0.1	0.10	0	0.02	350
5	350	0.4	0.08	0	0.01	350
1	250	0.0	0.04	0	0.01	250
1	250	0.1	0.06	0	0.01	250
1	250	0.1	0.05	0	0.01	250
1	250	0.1	0.06	0	0.01	250
1	250	0.0	0.04	0	0.01	250
5	250	0.2	0.05	0	0.01	250
1	150	0.0	0.03	0	0.00	150
1	150	0.0	0.03	0	0.01	150
1	150	0.0	0.04	0	0.01	150
1	150	0.0	0.02	0	0.00	150
1	150	0.0	0.03	0	0.00	150
5	150	0.2	0.03	0	0.01	150

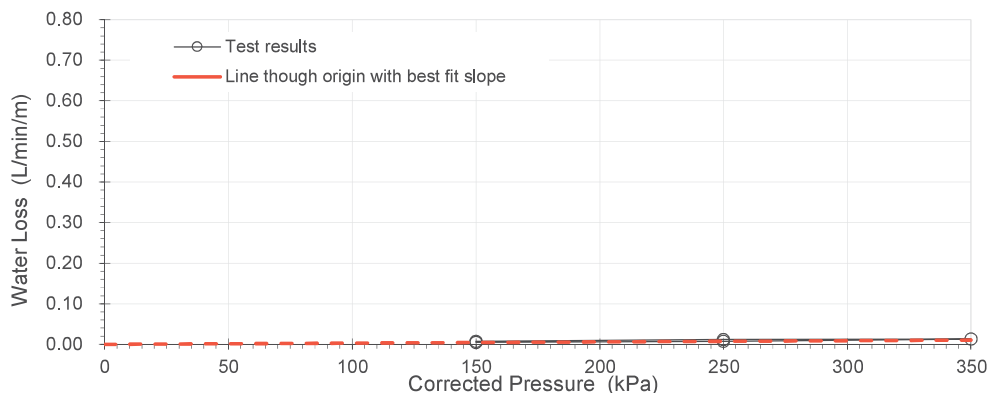

Interpreted Lugeon Permeability: **0.03 uL** (L/min/m @ 1000 kPa)

Borehole Water Pressure Test

Client **EMM CONSULTING PTY LTD**
Principal **Evolution Mining**
Project **CGO UNDERGROUND DEVELOPMENT EIS**
Location **North east of open pit outside lake bund**

Borehole **UG-BH-03**
Depth Interval **60.00-64.00 m**
Job No. **SYDGE206418-3**
Test date **19-2-2020**
Interpreted by **AO**
Checked **RJB**

Test Details		Packer type	Pneumatic		Borehole diam.	96 mm	
		Type of pump	Drill rig		Borehole inclination	90 degrees	
		Pressure gauge	Accu-Drive DD504N28-150D		Test interval length	4.00 m	
time interval (min)	gauge pressure (kPa)	water loss (L)	flow rate (L/min)	pressure correction (kPa)	water loss rate (L/min/m)	corrected pressure (kPa)	
1	150	0.0	0.00	0	0.00	150	
1	150	0.0	0.01	0	0.00	150	
1	150	0.0	0.00	0	0.00	150	
1	150	0.0	0.00	0	0.00	150	
1	150	0.0	0.00	0	0.00	150	
5	150	0.0	0.00	0	0.00	150	
1	250	0.0	0.00	0	0.00	250	
1	250	0.0	0.00	0	0.00	250	
1	250	0.0	0.00	0	0.00	250	
1	250	0.0	0.00	0	0.00	250	
1	250	0.0	0.00	0	0.00	250	
5	250	0.0	0.01	0	0.00	250	
1	350	0.0	0.02	0	0.00	350	
1	350	0.0	0.02	0	0.00	350	
1	350	0.0	0.02	0	0.00	350	
1	350	0.0	0.02	0	0.00	350	
1	350	0.0	0.01	0	0.00	350	
5	350	0.1	0.02	0	0.00	350	
1	250	0.0	0.01	0	0.00	250	
1	250	0.0	0.00	0	0.00	250	
1	250	0.0	0.00	0	0.00	250	
1	250	0.0	0.00	0	0.00	250	
1	250	0.0	0.01	0	0.00	250	
5	250	0.0	0.00	0	0.00	250	
1	150	0.0	0.00	0	0.00	150	
1	150	0.0	0.00	0	0.00	150	
1	150	0.0	0.00	0	0.00	150	
1	150	0.0	0.00	0	0.00	150	
1	150	0.0	0.00	0	0.00	150	
5	150	0.0	0.00	0	0.00	150	

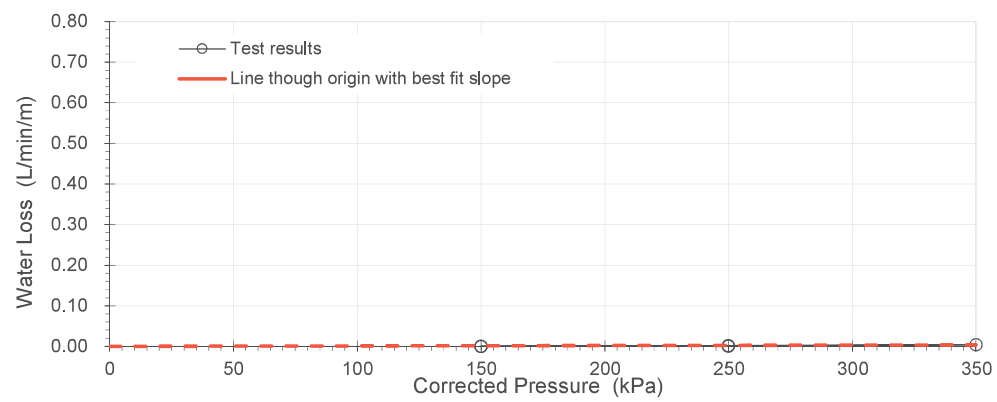

Interpreted Lugeon Permeability: **0.01 uL** (L/min/m @ 1000 kPa)

Borehole Water Pressure Test

Client **EMM CONSULTING PTY LTD**
 Principal **Evolution Mining**
 Project **CGO UNDERGROUND DEVELOPMENT EIS**
 Location **North east of open pit outside lake bund**

Borehole **UG-BH-03**
 Depth Interval **65.00-72.00 m**
 Job No. **SYDGE206418-3**
 Test date **20-2-2020**
 Interpreted by **AO**
 Checked **RJB**

Test Details	Packer type	Pneumatic	Borehole diam.	96 mm
	Type of pump	Drill rig	Borehole inclination	90 degrees
	Pressure gauge	Accu-Drive DD504N28-150D	Test interval length	7.00 m

time interval (min)	gauge pressure (kPa)	water loss (L)	flow rate (L/min)	pressure correction (kPa)	water loss rate (L/min/m)	corrected pressure (kPa)
1	150	0.0	0.00	0	0.00	150
1	150	0.0	0.01	0	0.00	150
1	150	0.0	0.00	0	0.00	150
1	150	0.0	0.00	0	0.00	150
1	150	0.0	0.01	0	0.00	150
5	150	0.0	0.00	0	0.00	150
1	250	0.0	0.01	0	0.00	250
1	250	0.0	0.00	0	0.00	250
1	250	0.0	0.01	0	0.00	250
1	250	0.0	0.01	0	0.00	250
1	250	0.0	0.00	0	0.00	250
5	250	0.0	0.01	0	0.00	250
1	350	0.0	0.02	0	0.00	350
1	350	0.0	0.03	0	0.00	350
1	350	0.0	0.02	0	0.00	350
1	350	0.0	0.03	0	0.00	350
1	350	0.0	0.02	0	0.00	350
5	350	0.1	0.02	0	0.00	350
1	250	0.0	0.00	0	0.00	250
1	250	0.0	0.01	0	0.00	250
1	250	0.0	0.00	0	0.00	250
1	250	0.0	0.00	0	0.00	250
1	250	0.0	0.00	0	0.00	250
5	250	0.0	0.00	0	0.00	250
1	150	0.0	0.00	0	0.00	150
1	150	0.0	0.00	0	0.00	150
1	150	0.0	0.00	0	0.00	150
1	150	0.0	0.00	0	0.00	150
1	150	0.0	0.00	0	0.00	150
5	150	0.0	0.00	0	0.00	150

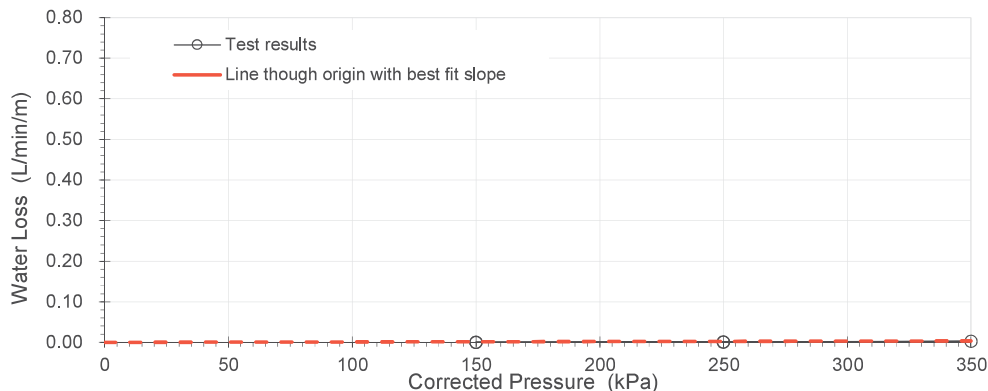

Interpreted Lugeon Permeability: **0.01 uL** (L/min/m @ 1000 kPa)

Borehole Water Pressure Test

Client **EMM CONSULTING PTY LTD**
 Principal **Evolution Mining**
 Project **CGO UNDERGROUND DEVELOPMENT EIS**
 Location **North east of open pit outside lake bund**

Borehole **UG-BH-04**
 Depth Interval **54.00-59.00 m**
 Job No. **SYDGE206418-3**
 Test date **23-2-2020**
 Interpreted by **AO**
 Checked **RJB**

Test Details		Packer type	Pneumatic	Borehole diam.	96 mm	
		Type of pump	Drill rig	Borehole inclination	90 degrees	
		Pressure gauge	Accu-Drive DD504N28-150D	Test interval length	5.00 m	
time interval (min)	gauge pressure (kPa)	water loss (L)	flow rate (L/min)	pressure correction (kPa)	water loss rate (L/min/m)	corrected pressure (kPa)
1	150	1.1	1.15	0	0.23	150
1	150	0.7	0.65	0	0.13	150
1	150	0.9	0.92	0	0.18	150
1	150	1.1	1.10	0	0.22	150
1	150	0.8	0.76	0	0.15	150
5	150	3.5	0.71	0	0.14	150
1	250	1.4	1.39	0	0.28	250
1	250	1.1	1.12	0	0.22	250
1	250	1.4	1.36	0	0.27	250
1	250	1.2	1.15	0	0.23	250
1	250	1.3	1.34	0	0.27	250
5	250	6.1	1.21	0	0.24	250
1	350	2.4	2.38	0	0.48	350
1	350	2.3	2.33	0	0.47	350
1	350	1.8	1.82	0	0.36	350
1	350	2.2	2.17	0	0.43	350
1	350	1.9	1.94	0	0.39	350
5	350	8.9	1.78	0	0.36	350
1	250	1.6	1.61	0	0.32	250
1	250	1.6	1.65	0	0.33	250
1	250	1.7	1.70	0	0.34	250
1	250	1.6	1.64	0	0.33	250
1	250	1.7	1.69	0	0.34	250
5	250	7.3	1.45	0	0.29	250
1	150	1.1	1.11	0	0.22	150
1	150	1.2	1.23	0	0.25	150
1	150	1.3	1.26	0	0.25	150
1	150	0.7	0.67	0	0.13	150
1	150	0.8	0.82	0	0.16	150
5	150	4.0	0.79	0	0.16	150

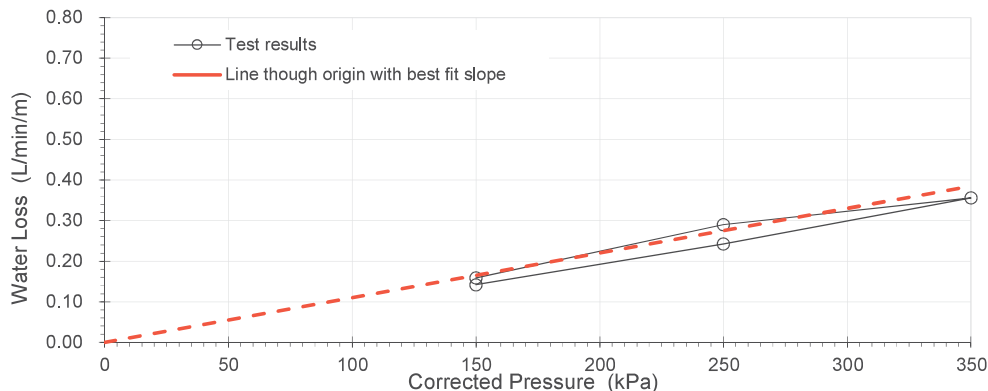

Interpreted Lugeon Permeability: **1.1 uL** (L/min/m @ 1000 kPa)

Borehole Water Pressure Test

Client **EMM CONSULTING PTY LTD**
 Principal **Evolution Mining**
 Project **CGO UNDERGROUND DEVELOPMENT EIS**
 Location **North east of open pit outside lake bund**

Borehole **UG-BH-04**
 Depth Interval **63.00-68.00 m**
 Job No. **SYDGE206418-3**
 Test date **23-2-2020**
 Interpreted by **AO**
 Checked **RJB**

Test Details	Packer type	Pneumatic	Borehole diam.	96 mm
	Type of pump	Drill rig	Borehole inclination	90 degrees
	Pressure gauge	Accu-Drive DD504N28-150D	Test interval length	5.00 m

time interval (min)	gauge pressure (kPa)	water loss (L)	flow rate (L/min)	pressure correction (kPa)	water loss rate (L/min/m)	corrected pressure (kPa)
1	150	0.1	0.08	0	0.02	150
1	150	0.1	0.14	0	0.03	150
1	150	-0.2	-0.19	0	-0.04	150
1	150	0.0	0.01	0	0.00	150
1	150	0.0	-0.01	0	0.00	150
5	150	0.0	0.01	0	0.00	150
1	250	0.0	0.02	0	0.00	250
1	250	0.0	0.00	0	0.00	250
1	250	0.1	0.08	0	0.02	250
1	250	0.0	0.05	0	0.01	250
1	250	0.0	0.01	0	0.00	250
5	250	0.1	0.02	0	0.00	250
1	350	0.1	0.06	0	0.01	350
1	350	0.1	0.07	0	0.01	350
1	350	0.1	0.08	0	0.02	350
1	350	0.1	0.10	0	0.02	350
1	350	0.1	0.07	0	0.01	350
5	350	0.4	0.09	0	0.02	350
1	250	0.0	0.01	0	0.00	250
1	250	0.0	-0.01	0	0.00	250
1	250	0.0	0.00	0	0.00	250
1	250	0.0	-0.03	0	-0.01	250
1	250	0.0	0.02	0	0.00	250
5	250	0.0	0.00	0	0.00	250
1	150	0.0	0.05	0	0.01	150
1	150	0.0	-0.01	0	0.00	150
1	150	0.0	-0.02	0	0.00	150
1	150	0.0	0.01	0	0.00	150
1	150	0.0	0.00	0	0.00	150
5	150	0.0	0.00	0	0.00	150

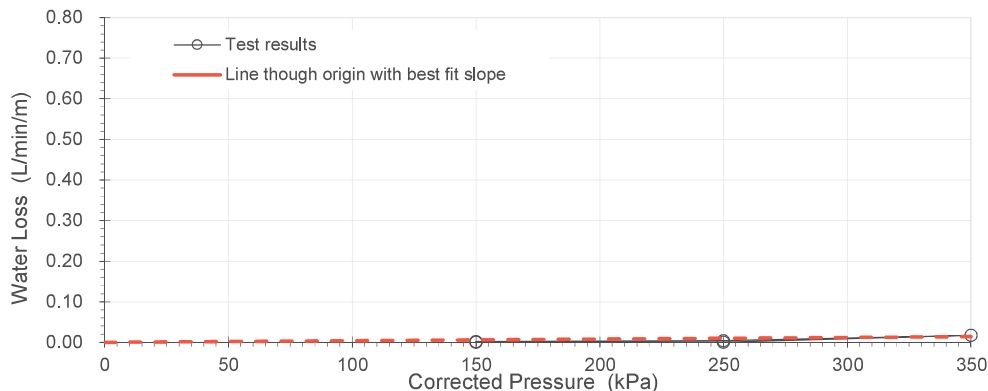

Interpreted Lugeon Permeability: **0.04 uL** (L/min/m @ 1000 kPa)

Borehole Water Pressure Test

Client **EMM CONSULTING PTY LTD**
Principal **Evolution Mining**
Project **CGO UNDERGROUND DEVELOPMENT EIS**
Location **North east of open pit outside lake bund**

Borehole **UG-BH-04**
Depth Interval **72.00-77.00 m**
Job No. **SYDGE206418-3**
Test date **23-2-2020**
Interpreted by **AO**
Checked **RJB**

Test Details		Packer type	Pneumatic	Borehole diam.	96 mm	
		Type of pump	Drill rig	Borehole inclination	90 degrees	
		Pressure gauge	Accu-Drive DD504N28-150D	Test interval length	5.00 m	
time interval (min)	gauge pressure (kPa)	water loss (L)	flow rate (L/min)	pressure correction (kPa)	water loss rate (L/min/m)	corrected pressure (kPa)
1	150	1.1	1.08	0	0.22	150
1	150	1.3	1.25	0	0.25	150
1	150	1.1	1.12	0	0.22	150
1	150	1.3	1.25	0	0.25	150
1	150	1.2	1.18	0	0.24	150
5	150	3.7	0.74	0	0.15	150
1	250	1.4	1.36	0	0.27	250
1	250	1.4	1.38	0	0.28	250
1	250	1.4	1.39	0	0.28	250
1	250	1.7	1.65	0	0.33	250
1	250	1.3	1.30	0	0.26	250
5	250	6.7	1.33	0	0.27	250
1	350	1.8	1.81	0	0.36	350
1	350	1.8	1.83	0	0.37	350
1	350	2.0	2.04	0	0.41	350
1	350	1.9	1.92	0	0.38	350
1	350	1.9	1.91	0	0.38	350
5	350	9.4	1.89	0	0.38	350
1	250	1.7	1.74	0	0.35	250
1	250	1.7	1.65	0	0.33	250
1	250	1.5	1.55	0	0.31	250
1	250	1.4	1.43	0	0.29	250
1	250	1.7	1.68	0	0.34	250
5	250	6.8	1.36	0	0.27	250
1	150	1.0	0.97	0	0.19	150
1	150	1.3	1.27	0	0.25	150
1	150	1.2	1.24	0	0.25	150
1	150	1.3	1.29	0	0.26	150
1	150	1.4	1.41	0	0.28	150
5	150	5.8	1.16	0	0.23	150

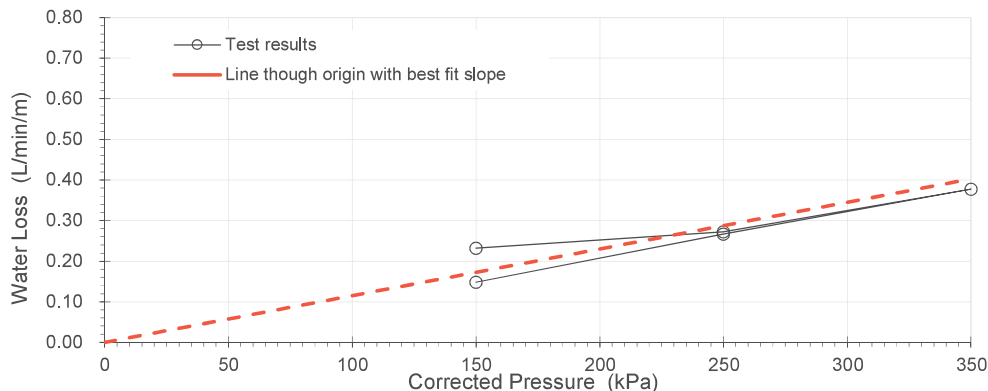

Interpreted Lugeon Permeability: **1.2 uL** (L/min/m @ 1000 kPa)

Borehole Water Pressure Test

Client **EMM CONSULTING PTY LTD**
 Principal **Evolution Mining**
 Project **CGO UNDERGROUND DEVELOPMENT EIS**
 Location **North east of open pit outside lake bund**

Borehole **UG-BH-04**
 Depth Interval **91.00-102.00 m**
 Job No. **SYDGE206418-3**
 Test date **23-2-2020**
 Interpreted by **AO**
 Checked **RJB**

Test Details	Packer type	Pneumatic	Borehole diam.	96 mm
	Type of pump	Drill rig	Borehole inclination	90 degrees
	Pressure gauge	Accu-Drive DD504N28-150D	Test interval length	11.00 m

time interval (min)	gauge pressure (kPa)	water loss (L)	flow rate (L/min)	pressure correction (kPa)	water loss rate (L/min/m)	corrected pressure (kPa)
1	150	0.0	0.03	0	0.00	150
1	150	0.0	0.04	0	0.00	150
1	150	0.0	0.04	0	0.00	150
1	150	0.1	0.06	0	0.01	150
1	150	0.1	0.07	0	0.01	150
5	150	0.1	0.02	0	0.00	150
1	250	0.0	0.03	0	0.00	250
1	250	0.0	0.03	0	0.00	250
1	250	0.0	0.03	0	0.00	250
1	250	0.0	0.02	0	0.00	250
1	250	0.0	0.00	0	0.00	250
5	250	0.0	0.00	0	0.00	250
1	350	0.0	0.00	0	0.00	350
1	350	0.0	0.00	0	0.00	350
1	350	0.0	0.00	0	0.00	350
1	350	0.0	-0.01	0	0.00	350
1	350	0.0	0.00	0	0.00	350
5	350	0.0	0.00	0	0.00	350
1	250	0.0	0.00	0	0.00	250
1	250	0.0	-0.02	0	0.00	250
1	250	0.0	0.00	0	0.00	250
1	250	0.0	0.00	0	0.00	250
1	250	0.0	0.00	0	0.00	250
5	250	0.0	0.00	0	0.00	250
1	150	0.0	0.00	0	0.00	150
1	150	0.0	0.00	0	0.00	150
1	150	0.0	-0.02	0	0.00	150
1	150	0.0	0.00	0	0.00	150
1	150	0.0	0.00	0	0.00	150
5	150	0.0	0.00	0	0.00	150

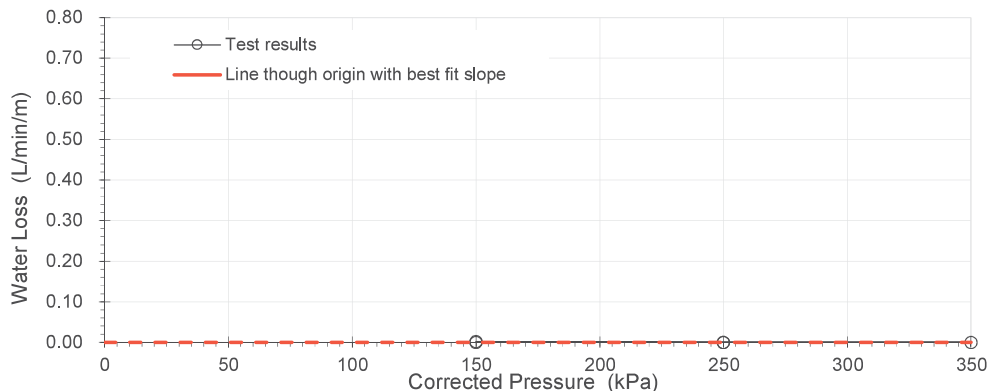

Interpreted Lugeon Permeability: **0 uL** (L/min/m @ 1000 kPa)

Appendix D – Seepage into exploration decline

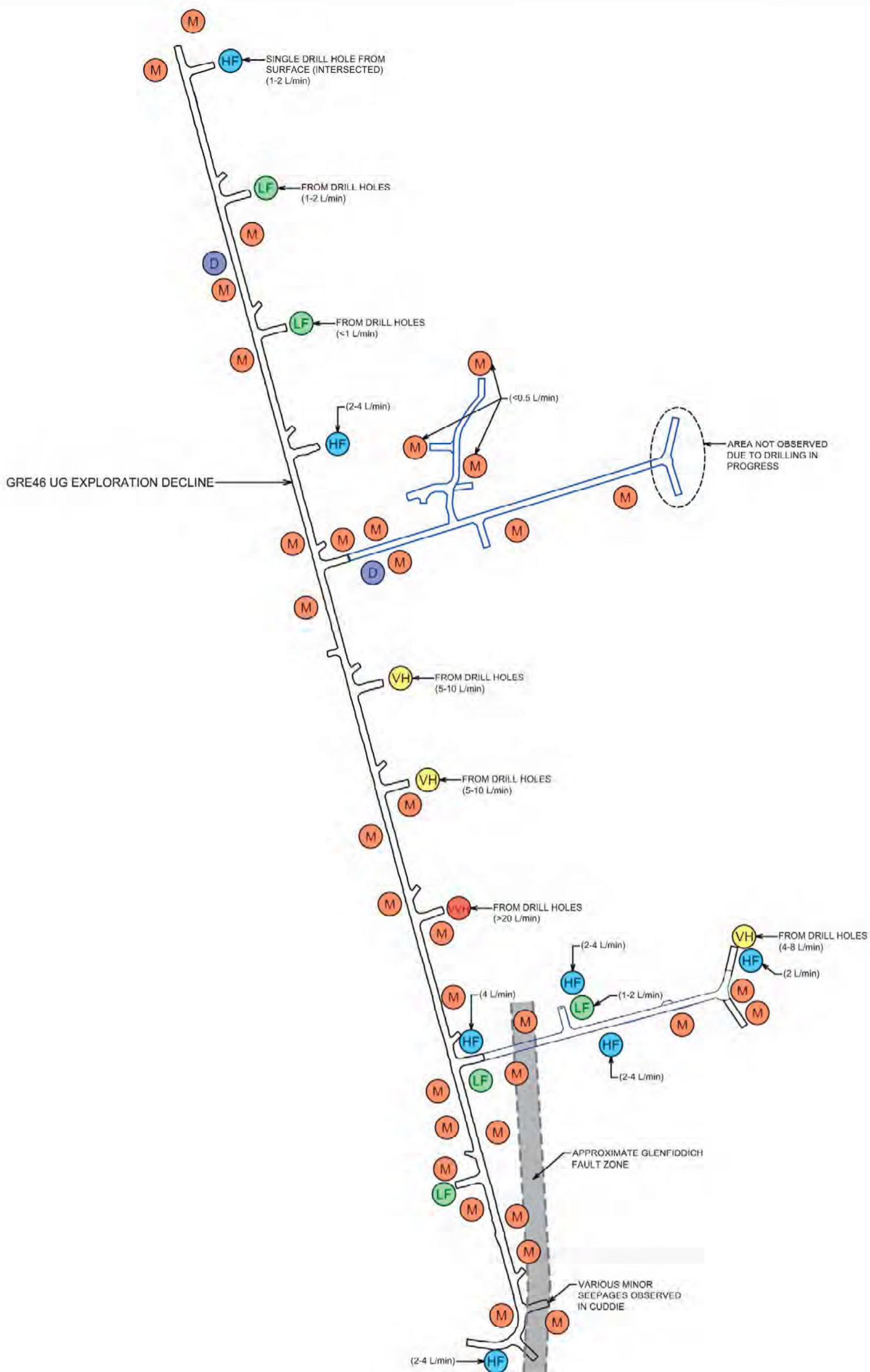

LEGEND

- VERY HIGH FLOW (MORE THAN 10 L/min)
- VERY HIGH FLOW (5-10 L/min)
- HIGH FLOW (2-5 L/min)
- LIGHT FLOW (1-2 L/min)
- MINOR SEEPAGE (LESS THAN 1 L/min)
- DAMP ROCK

NOTE:
FOR MAP CLARITY NOT ALL SEEPAGE LOCATIONS ARE MARKED WITH AN INDIVIDUAL SYMBOL.

DRAFT

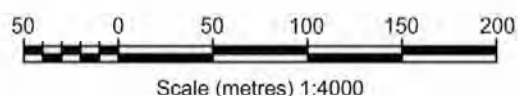

drawn	AO / AW
approved	-
date	23/03/2020
scale	AS SHOWN
original size	A3



client:	EMM CONSULTING PTY LTD		
project:	CGO UNDERGROUND DEVELOPMENT EIS		
title:	SEEPAGE INTO GRE46 UG EXPLORATION DECLINE		
project no:	754-SYDGE206418-3-AJ	figure no:	FIGURE D1
		rev:	A

ANALYTIC ESTIMATE OF GROUNDWATER INFLOW TO EQUIVALENT TUNNEL OF EQUAL LENGTH TO GRE46 EXPLORATION DECLINE

	tunnel lengths (m)	tunnel elev (m AHD)	Tunnel ID
EQUIVALENT TUNNEL	1274	100 to -100	Main tunnel
diameter	6.5	261	60 1057 arm
length	2010 m	350	-15 985 arm (main)
gwl	200 m AHD (average)	125	-15 985 arm (north branch)
	2010 m (total)		

The equation shown below (for example see Best and Parker, 2004) is used to approximate inflow into the tunnel under the assumption that the tunnel is circular (diameter, D) contained within material of uniform hydraulic conductivity (k), and with groundwater head at height (H) above the tunnel centreline.

$$q = \frac{2\pi kH}{\ln\left(\frac{4H}{D}\right)} \quad (\text{inflow volume per m run of tunnel})$$

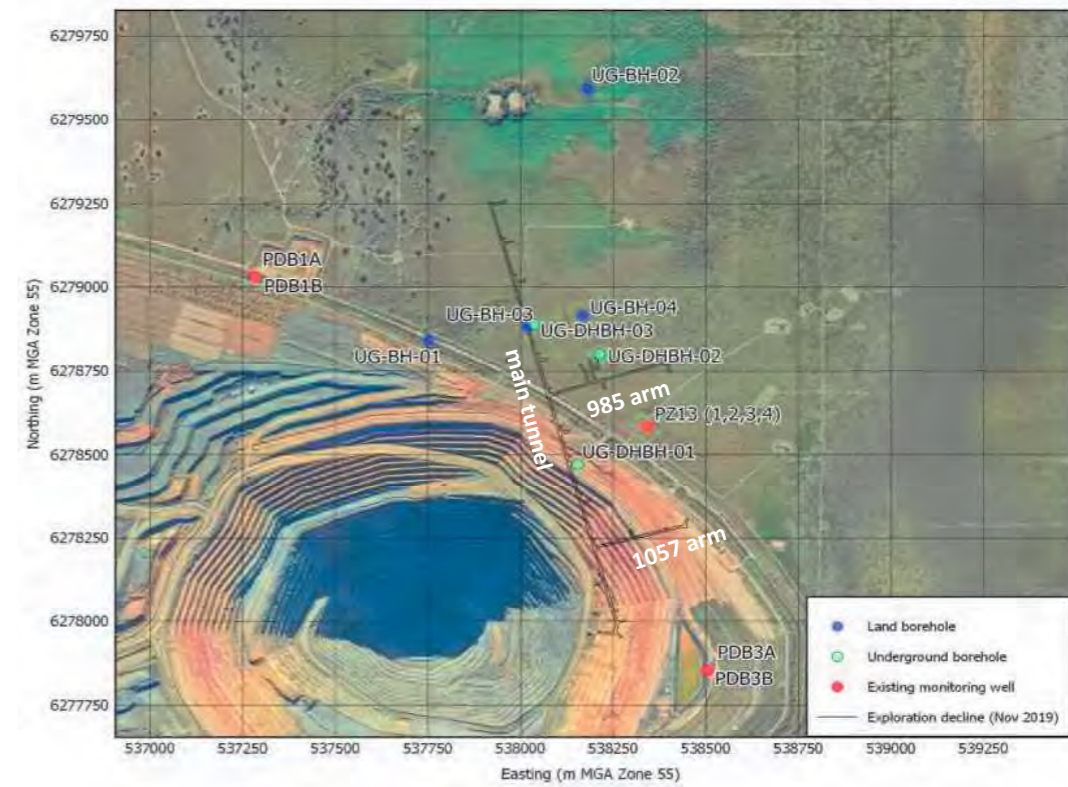

Main tunnel

chainage	Tunnel elev (m AHD)	gwl (m AHD)	H (m)	q m3/m run	Q (m3)
0	100.0	200	100.0	8.39E-07	8.39E-05
100	84.3	200	115.7	9.37E-07	9.37E-05
200	68.6	200	131.4	1.03E-06	1.03E-04
300	52.9	200	147.1	1.13E-06	1.13E-04
400	37.2	200	162.8	1.22E-06	1.22E-04
500	21.5	200	178.5	1.31E-06	1.31E-04
600	5.8	200	194.2	1.40E-06	1.40E-04
700	-9.9	200	209.9	1.49E-06	1.49E-04
800	-25.6	200	225.6	1.58E-06	1.58E-04
900	-41.3	200	241.3	1.67E-06	1.67E-04
1000	-57.0	200	257.0	1.75E-06	1.75E-04
1100	-72.7	200	272.7	1.84E-06	1.84E-04
1200	-88.4	200	288.4	1.92E-06	1.92E-04
1300	-104.1				

1.81E-03 m3 / s
156.66 m3 / day

Side tunnels

name	length	Tunnel elev (m AHD)	gwl (m AHD)	H (m)	q m3/m run	Q (m3)	
1057 arm		261	60	200	140.0	1.09E-06	2.83E-04
985 arm (main)		350	-15	200	215.0	1.52E-06	5.32E-04
985 arm (north branch)		125	-15	200	215.0	1.52E-06	1.90E-04

1.01E-03 m3 / s
86.90 m3 / day

k 5.50E-09 m/s (adopted hydraulic conductivity)

Resulting flow 243.57 m3 / day
2.8 L / s

Reference:

Best R.J. and Parker C.J. (2004). Groundwater in Sydney – Tunnel inflows and settlement – Theory and experience

Appendix E – Piezometer details and groundwater monitoring hydrographs

UG-BH-01 - PIEZOMETER CONSTRUCTION

Borehole	UG-BH-01
Hole depth (m)	72.0
Telemetry ID	Coffey3
Telemetry S/N	05011943000056
Phone number for SMS data request (SMS the word 'ETRAIA' to request data)	0436 841 933

Sensor ID	SG1	SG2	SG3	
Downhole depth (m)	15.0	30.0	70.0	
Sensor model	SGP-3400	SGP-3400	SGP-3400	
Sensor serial number	SG00699	SG00700	SG00704	
Logger channel	2	3	5	
Calibration (in air)	Reading mA	4.013	4.002	4.006
	Temperature (°C)	18	18	19
	Barometer (hPa)	995	995	985
	Date	25-Nov-19	25-Nov-19	28-Nov-19
	Linear factor (kPa per mA)	127.32	127.62	129.26
Grout mix (by weight)	Cement	1		
	Bentonite	0.3		
	Water	3		

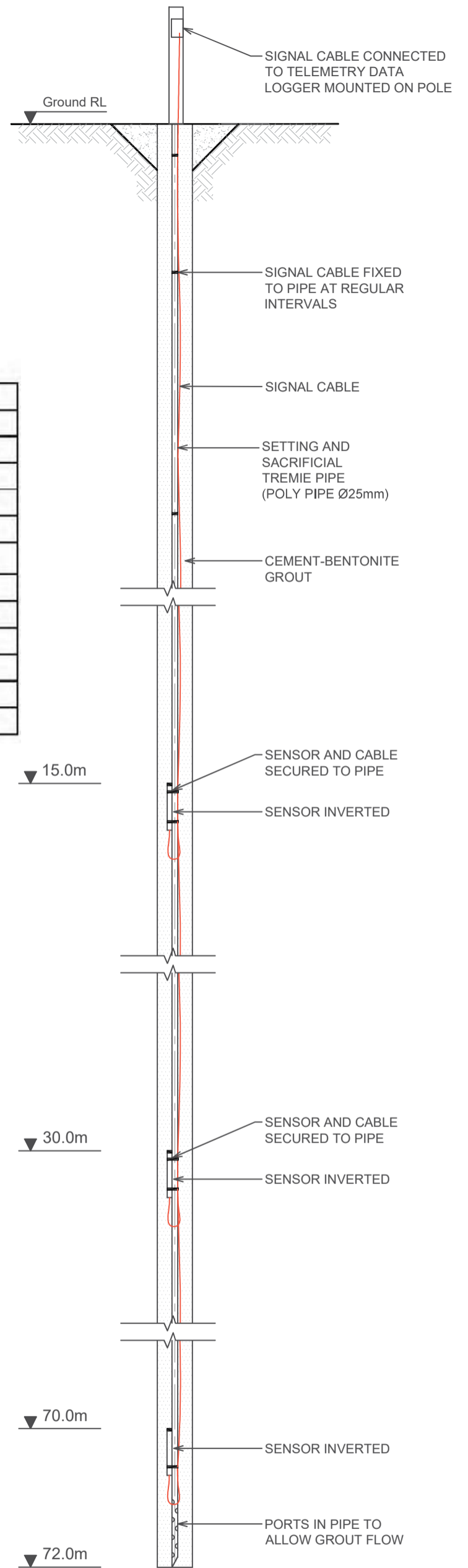

PIEZOMETER SECTION

drawn	AO / AW
approved	RJB
date	23/03/2020
scale	N.T.S.
original size	A3



client:	EMM CONSULTING PTY LTD		
project:	CGO UNDERGROUND DEVELOPMENT EIS		
title:	AS-INSTALLED INSTRUMENTATION - UG-BH-01		
project no:	754-SYDGE206418-3-AJ	figure no:	FIGURE E1
		rev:	A

UG-BH-02 - PIEZOMETER CONSTRUCTION

Borehole	UG-BH-02
Hole depth (m)	102.8
Telemetry ID	Coffey4
Telemetry S/N	05011943000055
Phone number for SMS data request (SMS the word 'ETRAIA')	0436 841 932

Sensor ID	SG1	SG2	SG3	
Downhole depth (m)	13.0	43.0	100.0	
Sensor model	SGP-3400	SGP-3400	SGP-3400	
Sensor serial number	SG00698	SG00701	SG00706	
Logger channel	2	3	5	
Calibration (in air)	Reading mA	4.02	4.009	4.013
	Temperature (°C)	18	18	19
	Barometer (hPa)	995	995	985
	Date	25-Nov-19	25-Nov-19	28-Nov-19
	Linear factor (kPa per mA)	129.42	129.28	129.29
Grout mix (by weight)	Cement	1		
	Bentonite	0.3		
	Water	3		

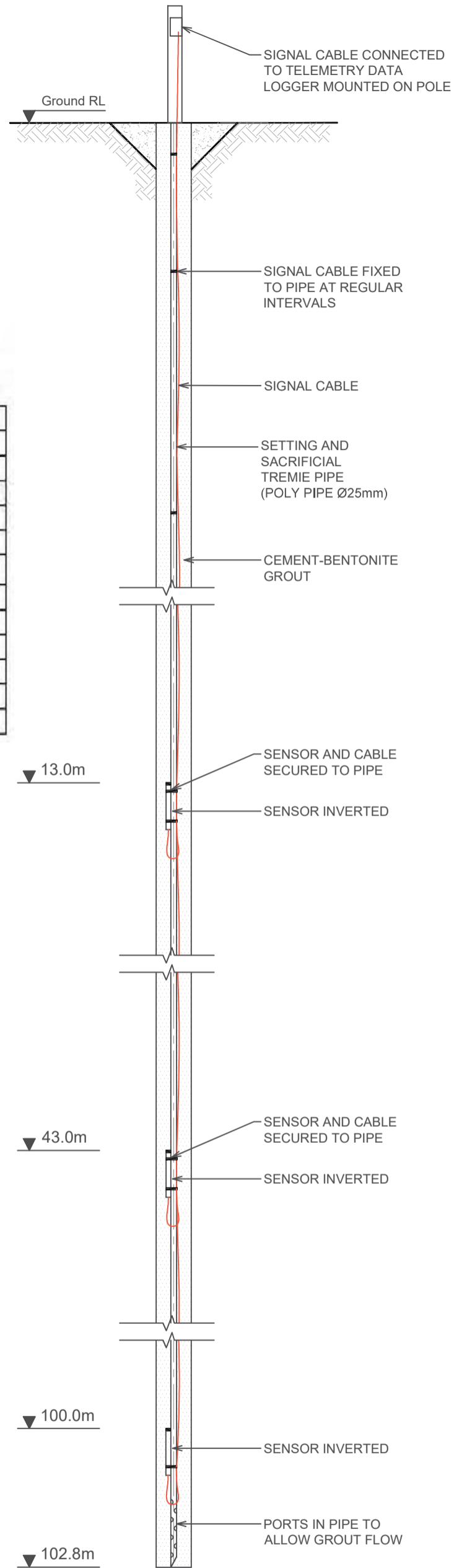

PIEZOMETER SECTION

drawn	AO / AW
approved	RJB
date	23/03/2020
scale	N.T.S.
original size	A3



client:	EMM CONSULTING PTY LTD		
project:	CGO UNDERGROUND DEVELOPMENT EIS		
title:	AS-INSTALLED INSTRUMENTATION - UG-BH-02		
project no:	754-SYDGE206418-3-AJ	figure no:	FIGURE E2
		rev:	A

UG-BH-03 - PIEZOMETER CONSTRUCTION

Borehole	UG-BH-03
Hole depth (m)	72.0
Telemetry ID	Coffey2
Telemetry S/N	05011943000054
Phone number for SMS data request (SMS the word 'ETRAIA')	0436 841 938

Sensor ID	SG1	SG2	SG3	
Downhole depth (m)	15.0	30.0	70.0	
Sensor model	SGP-3400	SGP-3400	SGP-3400	
Sensor serial number	SG00696	SG00695	SG00703	
Logger channel	2	3	5	
Calibration (in air)	Reading mA	4.023	4.005	4.004
	Temperature (°C)	18	18	19
	Barometer (hPa)	995	995	985
	Date	25-Nov-19	25-Nov-19	28-Nov-19
	Linear factor (kPa per mA)	129.46	127.41	129.25
Grout mix (by weight)	Cement	1		
	Bentonite	0.3		
	Water	3		

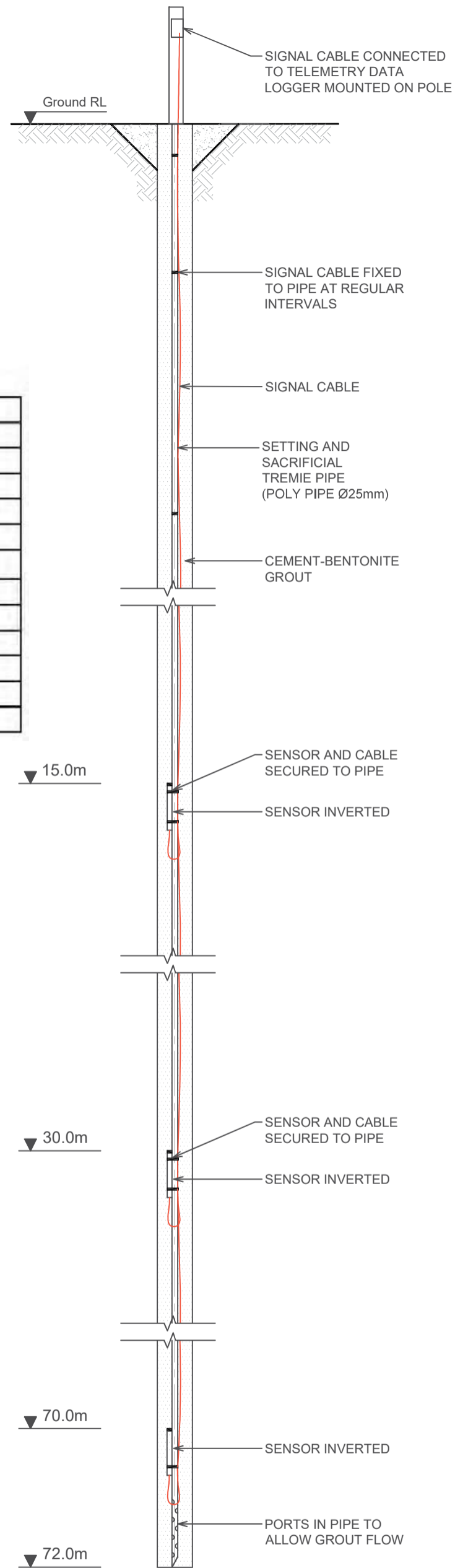

PIEZOMETER SECTION

PLOT DATE: 23/03/2020 9:12:52 AM DWG FILE: F:\11. PROJECTS\4. SYDGE\TECHNIC\3019\SYDGE206418-3 COVAL GOLD EIS\11. CAD\754SYDGE206418-3-AJ.DWG

drawn AO / AW approved RJB date 23/03/2020 scale N.T.S. original size A3	client: EMM CONSULTING PTY LTD	
	project: CGO UNDERGROUND DEVELOPMENT EIS	
	title: AS-INSTALLED INSTRUMENTATION - UG-BH-03	
	project no: 754-SYDGE206418-3-AJ	figure no: FIGURE E3
	rev: A	



UG-BH-04 - PIEZOMETER CONSTRUCTION

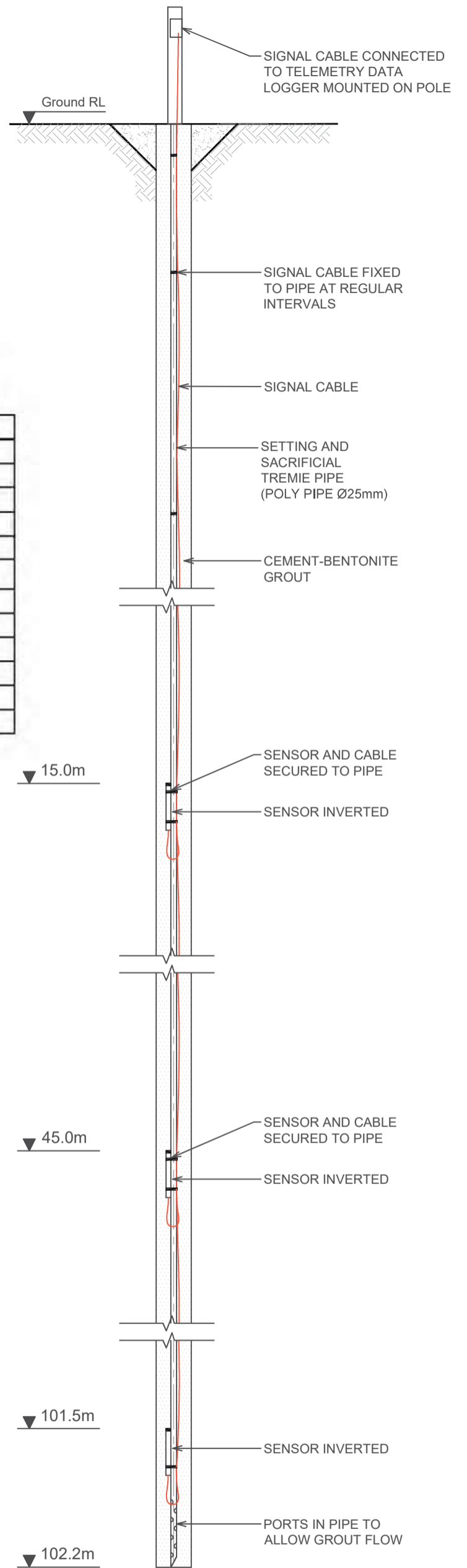

PIEZOMETER SECTION

Borehole	UG-BH-04
Hole depth (m)	102.2
Telemetry ID	Coffey1
Telemetry S/N	05011943000053
Phone number for SMS data request (SMS the word 'ETRAIA')	0436 841 939

Sensor ID	SG1	SG2	SG3	
Downhole depth (m)	15.0	45.0	101.5	
Sensor model	SGP-3400	SGP-3400	SGP-3400	
Sensor serial number	SG00697	SG00702	SG00705	
Logger channel	2	3	5	
Calibration (in air)	Reading mA	4.011	4.019	4.007
	Temperature (°C)	18	18	19
	Barometer (hPa)	995	995	985
	Date	25-Nov-19	25-Nov-19	28-Nov-19
	Linear factor (kPa per mA)	129.29	127.30	129.27
Grout mix (by weight)	Cement	1		
	Bentonite	0.3		
	Water	3		

PLOT DATE: 23/03/2020 9:13:09 AM DWG FILE: F:\11-PROJECTS\4-SYDGE\TECHNICAL\SYDGE206418-3-AJ\DWG

drawn	AO / AW
approved	RJB
date	23/03/2020
scale	N.T.S.
original size	A3



client:	EMM CONSULTING PTY LTD		
project:	CGO UNDERGROUND DEVELOPMENT EIS		
title:	AS-INSTALLED INSTRUMENTATION - UG-BH-04		
project no:	754-SYDGE206418-3-AJ	figure no:	FIGURE E4
		rev:	A

Groundwater hydrographs - CGO Underground Development EIS

Groundwater levels - UG-BH-01

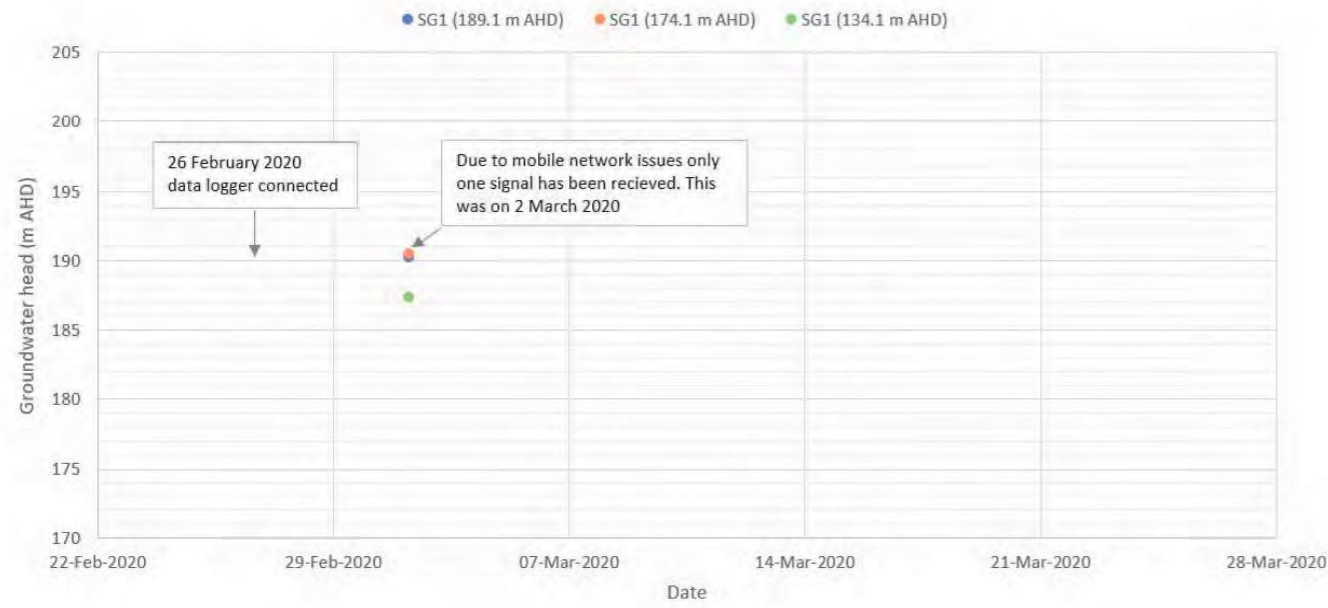

Groundwater levels - UG-BH-02

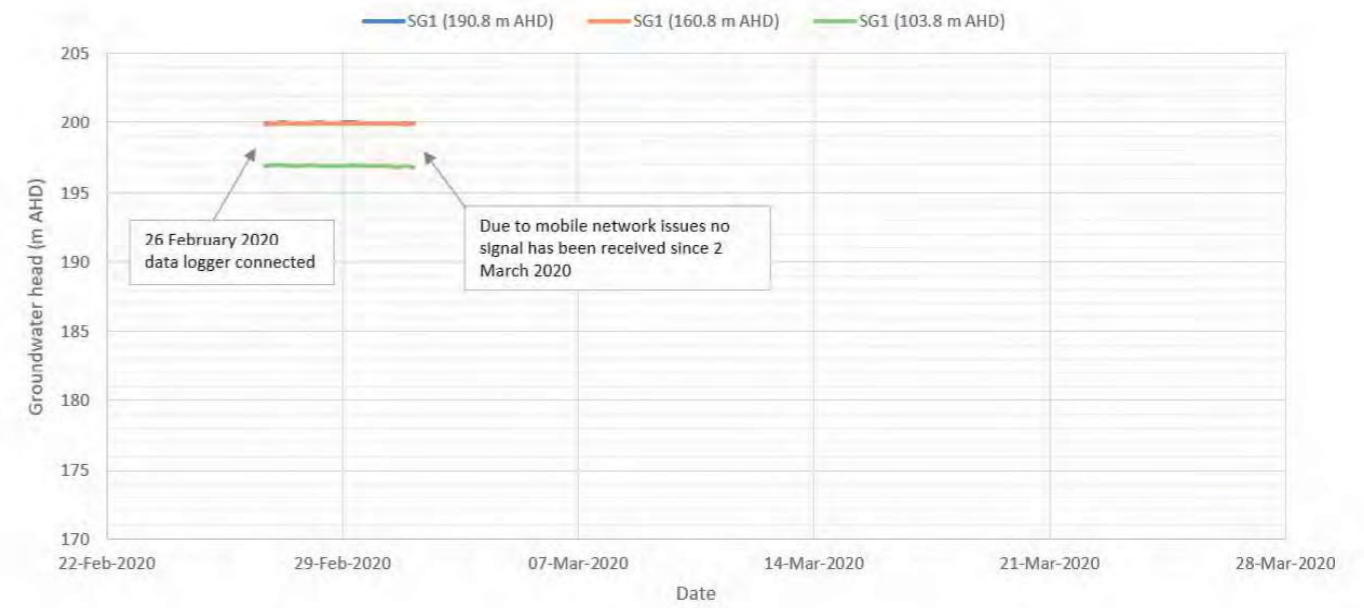

Groundwater levels - UG-BH-03

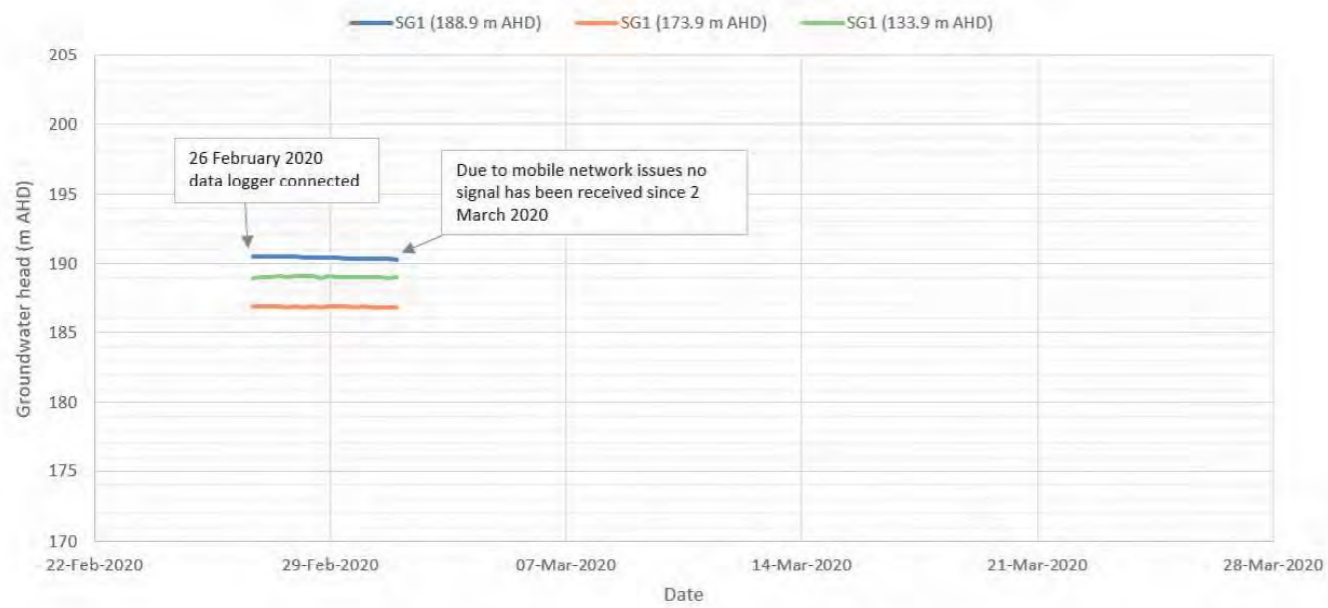

Groundwater levels - UG-BH-04

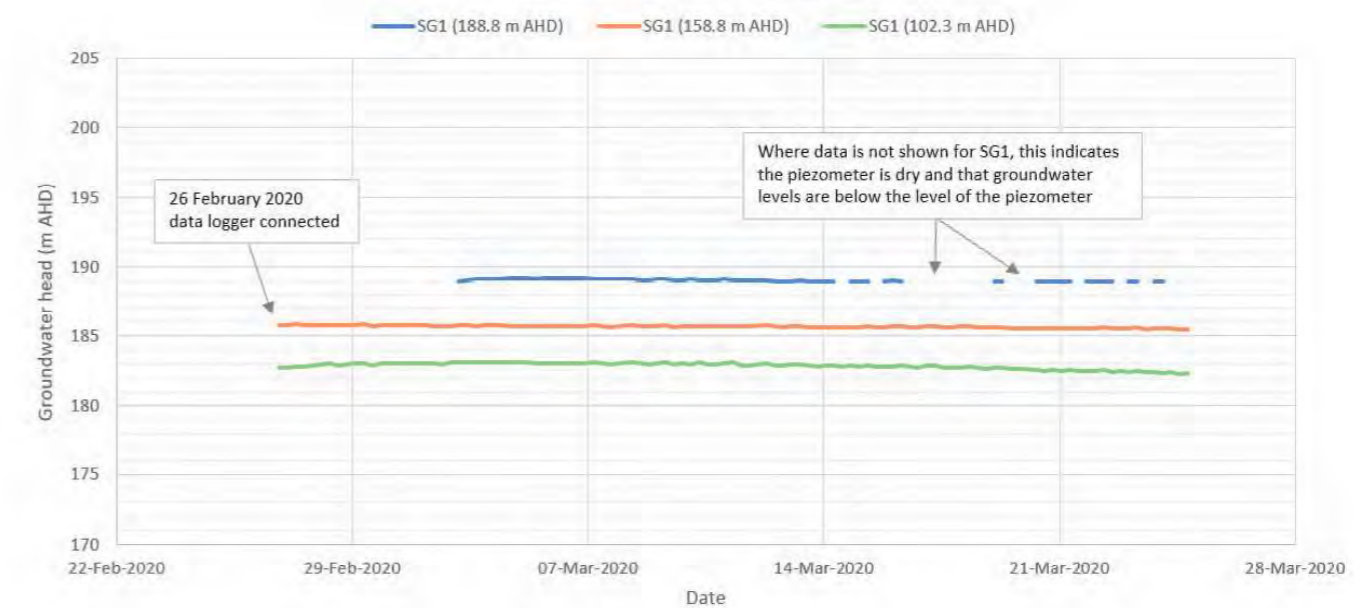

Groundwater levels - PDB1A/1B and PDB3A/3B



Groundwater levels - PZ13



EMM Consulting Pty Ltd

Cowal Gold Operations Underground EIS

Bland Creek Palaeochannel Borefield and
Eastern Saline Borefield Groundwater
Assessment

27 August 2020

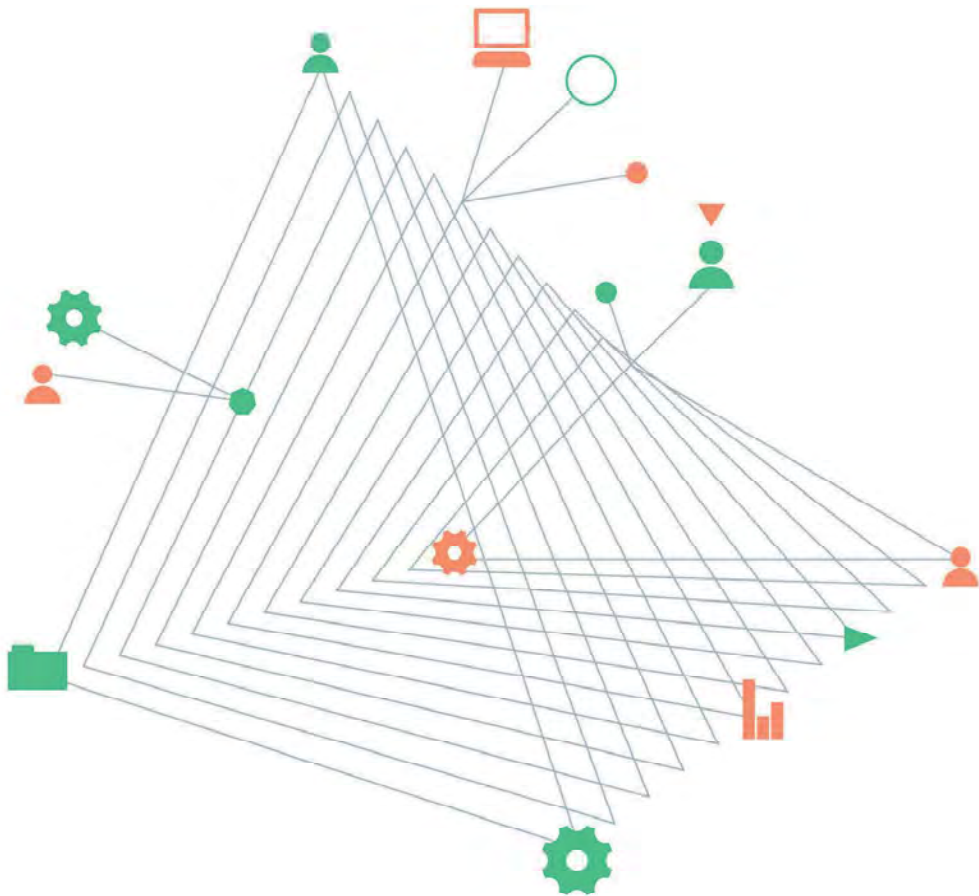

Experience
comes to life
when it is
powered by
expertise

Cowal Gold Operations Underground EIS

Prepared for
EMM Consulting Pty Ltd
Level 10, Suite 01
87 Wickham Terrace
Spring Hill QLD 4000

Prepared by
Coffey Services Australia Pty Ltd
Level 19, Tower B, Citadel Towers
799 Pacific Highway, Chatswood
NSW 2067 Australia
t: 9406 1000 f: 9406 1002
ABN: 55 139 460 521

27 August 2020

Document authorisation

Our ref: 754-SYDGE206418-3-AN-Rev1

Quality information

Revision history

Revision	Description	Date	Author	Reviewer	Signatory
Rev0	Draft Original	9 July 2020	Corinna De Castro	Ross Best	Ross Best
Rev1	EMM review comments addressed	27 August 2020	Corinna De Castro	Ross Best	Ross Best

Distribution

Report Status	No. of copies	Format	Distributed to	Date
Rev0 Draft	1	PDF	Paul Freeman EMM Consulting Pty Ltd	9 July 2020
Rev1	1	PDF	Paul Freeman EMM Consulting Pty Ltd	27 August 2020

Table of Contents

Executive Summary	ES-1
1. Introduction	1
1.1. CGO Underground Development.....	4
1.2. Approvals Strategy	4
1.3. Secretary’s Environmental Assessment Requirements	5
2. Legislation, Policy and Guidelines.....	7
3. Previous Studies.....	7
4. Site Characteristics.....	8
4.1. Topography	8
4.2. Climate	10
4.2.1. Regional Averages	10
4.2.2. Mine Site Rainfall	10
4.3. Surface Drainage	12
4.3.1. Recharge to the Water Table	14
4.4. Geology	16
4.5. Subsurface Hydraulic Properties.....	16
4.5.1. Hydraulic Conductivity	16
4.5.2. Storativity.....	18
4.6. Groundwater Levels and Flow	19
4.6.1. Monitoring Network	19
4.6.2. Hydrographs.....	19
4.6.3. Hydraulic Head Surfaces.....	22
4.6.4. Hydraulic Head Cross-Sections	22
4.7. Groundwater Salinity.....	25
4.7.1. Trend Analysis.....	27
4.8. Groundwater Extraction	28
4.9. BCPB and ESB usage	29
4.10. Groundwater Extraction to Date.....	30
5. Hydrogeological Conceptual Model.....	31
6. Numerical Model Development and Verification	33
6.1. Model Structure	33
6.2. Numerical Model Verification	37
6.3. Results	37
6.4. Model Classification	41

7.	Predictive Simulation	41
7.1.	Simulations	41
7.2.	Private Bore Pumping	42
7.2.1.	Inactive Pumping Bores	43
7.3.	Results	43
7.3.1.	Water Level Hydrographs.....	43
7.3.2.	Water Level Drawdown	46
7.3.3.	Flow Budgets.....	47
7.3.4.	Salinity	47
7.3.5.	Post-mining Water Levels	48
8.	Predictive Uncertainty Assessment.....	48
9.	Summary and Conclusions	50
9.1.	Predictive Simulation Results.....	50
9.2.	Regulatory Considerations	51
9.2.1.	Licence allocation for the BCPB.....	51
9.2.2.	Aquifer Interference Policy	51
9.2.3.	Lachlan Formation Water Source	51
9.2.4.	Cowra Formation Water Source.....	53
10.	Limitations	53
11.	Recommendations.....	53
12.	References	54

Important information about your Coffey Report

Tables

Table 1: Average rainfall and pan evaporation in the regional area

Table 2: High-extraction pumping areas in the regional area

Table 3: Pumping rates at the high extraction bores, averaged over the period 1 July 2004 to 31 December 2019

Table 4: Calibrated model media parameters

Table 5: Model over-prediction of DIW trigger piezometer hydrographs

Table 6: Private bore future average annual pumping rates for modelling

Table 7: Drawdown in the Lower Cowra and Lachlan Formations for 30 June 2040 (cessation of BCPB and ESB pumping)

Table 8: Registered private bores screened in the Cowra formation within 15 km of the BCPB and ESB (excluding government and Evolution bores)

Table 9: Flow budgets at the end of BCPB and ESB pumping (30 June 2040)

Figures

Figure 1-1: Cowal Gold Operations Location

Figure 1-2: BCPB and ESB location in relation to the CGO

Figure 1-3: Proposed Underground Development

Figure 4-1: Regional topography

Figure 4-2: Correlation of monthly rainfall from the CGO site weather station with two BoM stations for 2004 to 2015 inclusive

Figure 4-3: Observed water levels in Lake Cowal and flow at gauge 412103

Figure 4-4: Spatial relationship of water table piezometers (maintained by Jemalong Irrigation Limited) classified according to the dominant influence on their hydrographs. Numbers at piezometer locations are their names

Figure 4-5: Hydraulic conductivity database for the Bland Creek Palaeochannel area

Figure 4-6: Hydrographs for approximately coincident piezometers in the BCPB area

Figure 4-7: Monitoring piezometer hydrographs for the BCPB

Figure 4-8: Monitoring piezometer hydrographs for the ESB

Figure 4-9: Interpreted hydraulic head cross-section for December 1997

Figure 4-10: Interpreted hydraulic head cross-section for January 2010

Figure 4-11: EC of groundwater in the regional area versus depth. Error bars indicate one standard deviation either side of the mean

Figure 4-12: Groundwater EC versus time at Evolution monitoring piezometers

Figure 4-13: a) Comparison of average EC in the Lachlan Formation at the BCPB, and other trends; b) Correlation of EC and BCPB monthly derivatives

Figure 5-1: Hydrogeological conceptual model

Figure 6-1: Model domain

Figure 6-2: Model mesh

Figure 6-3: Model layers and boundary condition locations

Figure 6-4: Verification hydrographs for DIW trigger piezometers

Figure 6-5: Modelled versus observed groundwater levels

Figure 6-6: Calibration sensitivity to hydraulic conductivity parameters

Figure 6-7: Mass balance error (%) at selected times

Figure 7-1: Predictive hydrographs for DIW trigger piezometers for Case 1 (mine impact)

Figure 7-2: Modelled and observed TDS concentrations in the BCPB

Figure 8-1: Predictive uncertainty for modelled groundwater levels at trigger piezometer GW036553

Appendices

Appendix A - Specific Capacity Analysis

Appendix B - Groundwater Monitoring Network

Appendix C - Interpolated Hydraulic Head Surfaces

Appendix D - Groundwater Electrical Conductivity Averages

Appendix E - Pumping Bores

Appendix F - Bland Creek Palaeochannel Numerical Groundwater Flow Model

Appendix G - Verification Hydrographs

Appendix H - Drawdown in the Lower Cowra and Lachlan Formations at the end of BCPB and ESB Operation (30 June 2040)

Executive Summary

A groundwater assessment was undertaken to assess potential impacts due to groundwater extraction from the Bland Creek Palaeochannel Borefield (BCPB) and Eastern Saline Borefield (ESB) under the proposed Cowal Gold Operations (CGO) Underground Development Environmental Impact Statement (UG EIS). The assessment employed predictive numerical simulation using an existing numerical groundwater flow model. An assessment of potential impacts on the groundwater system at the mine site has been undertaken using a separate numerical groundwater flow model and is reported separately.

The NSW government monitors groundwater levels in the Lachlan Formation at the BCPB and ESB (at the request of the Bland Palaeochannel Groundwater Users Group) using the following monitoring piezometer (with respective trigger level):

- GW036553 (Investigation Trigger Level 137.5 metres Australian Height Datum (m AHD) and Mitigation Trigger Level 134 m AHD).

If the trigger level at GW036553 is breached, this would trigger actions at the BCPB to protect the groundwater resource from overuse. Groundwater from this palaeochannel is used for mine process water by CGO.

In addition to extraction for process water (from the BCPB), irrigators at the Billabong and Maslin farms also extract significant groundwater volumes from the palaeochannel. The NSW government monitors groundwater levels in the Lachlan Formation at the Billabong and Maslin Farms (at the request of the Bland Palaeochannel Groundwater Users Group) using the following monitoring piezometers (with respective trigger levels):

- Billabong Area: GW036597 (Trigger Level 143.7 m AHD).
- Maslin Area: GW036611 (Trigger Level 145.8 m AHD).

Over the period 1 July 2004 to 31 December 2019, the average total pumping rates at the largest groundwater extraction bores (4.1 Megalitres per day [ML/day] at the borefield supplying CGO, 2.8 ML/day at the Billabong bores, and 2.7 ML/day at the Maslin bore) resulted in groundwater levels above the trigger levels at each of the NSW government monitoring bores. Pumping rates for the Billabong and Maslin bores, as used in verification analysis, involve significant assumptions. The lowest observed groundwater levels over the period 1 July 2004 to 31 December 2019 were as follows:

- BCPB Area - GW036553: 7.5 m above trigger (141.5 m AHD on 15 January 2010).
- Billabong Area - GW036597: 1.5 m above trigger (145.2 m AHD on 21-23 November 2019).
- Maslin Area - GW036611: 1.6 m above trigger (147.4 m AHD on 16 December 2019).

Modelling results indicate that the BCPB can pump at a maximum rate of 4.0 ML/day, from 1 January 2020 to 30 June 2040 (with the ESB pumping at 1.5 ML/day), without causing the water level in monitoring piezometer GW036553 to fall below the mitigation trigger level of 134 m AHD. The effects of pumping at this rate were also assessed at the locations of monitoring piezometers GW036597 and GW036611 located 15 kilometres (km) south of the mine borefield. At these locations the incremental effects of pumping from the mine bores at 4.0 ML/d from 1 January 2020 to 30 June 2040 were added to a measure of low recorded groundwater levels at these locations (based on the average of the lowest five events on record). The predicted groundwater levels for the impact of mine water use remained above the trigger levels for these monitoring piezometers. Note that

groundwater levels at piezometers GW036597 and GW036611 do not govern the operation of the BCPB or ESB.

The trigger level for GW036553 (located near the mine borefield) is not predicted to be breached under the adopted model conditions, based on extraction at a uniform rate with time.

Considering the worst case scenario for model parameter uncertainty, the water level at trigger piezometer GW036553 would be predicted to reach the effective trigger level in late 2033. On the other hand, considering the best case scenario for model parameter uncertainty, the water level at GW036553 is predicted to be approximately 4 m higher than the effective trigger level in 2040.

The effects of the uncertainty in the rate of irrigator pumping from Billabong 3/6, Billabong 4 and Maslin are clearly evident. A 50% increase in the future pumping rate from these bores results in the predicted water level at GW036553 reaching the effective trigger level in 2026. This also shows the importance of climate on future groundwater availability. During periods of high irrigator pumping and drought, groundwater trigger levels for both the mine and irrigators will require management.

Maximum drawdowns at the end of mine life (2040) are predicted to be 40 m or less in the Lower Cowra Formation and 61 m or less in the Lachlan Formation within the BCPB. A maximum drawdown of about 32 m (in the Lower Cowra Formation) is modelled for GW029574 (a private bore listed on the NSW Government bore register), the only known water bore installed to a depth within the Lower Cowra Formation and within 15 km of the BCPB. However, the bore is 88 m deep and may be able to continue operation if the screen is sufficiently deep. Overall, maximum modelled drawdown in the Lower Cowra Formation (including drawdown at GW029574) due to the UG EIS is less than the drawdown in the Lower Cowra Formation predicted for Modification 13 (Coffey, 2016).

Previous simple numerical transport simulation indicates total dissolved solids (TDS) at BLPR1 will increase by about 20 percent (%) or less, by 31 December 2032, from pre-mining concentrations. Modelling of pumping ceasing at 31 December 2032 indicates TDS at BLPR1 will increase by about 40% or less, by 30 June 2040, from pre-mining concentrations.

At cessation of BCPB and ESB pumping, groundwater levels at GW036553 are predicted to recover to around 166 m AHD in 10 years (about 30 m below 1998 water levels), and would continue to gradually recover over time, to a level that is dependent on the volume historically pumped, private bore usage following mine closure, and climatic conditions.

1. Introduction

This report presents the results of a groundwater assessment of the Bland Creek Palaeochannel Borefield (BCPB) and Eastern Saline Borefield (ESB), both operated by Evolution Mining (Cowal) Pty Limited (Evolution) as water supplies for its Cowal Gold Operations (CGO). The CGO site is located approximately 350 kilometres (km) west of Sydney and 38 km north east of West Wyalong in New South Wales (NSW). The BCPB and the ESB are located approximately 20 km and 30 km north east of the CGO, respectively, within the Bland Creek Palaeochannel. Figure 1-1 shows the location of the CGO. Figure 1-2 shows the location of the BCPB and ESB in relation to the CGO.

Evolution is the owner and operator of the CGO, an existing open cut mine which has been operational since 2005 and has current approvals in place to continue processing ore at a rate of 9.8 million tonnes per annum (Mtpa) until 2032.

Evolution recently obtained approval for development of an exploration decline (GRE46 exploration decline) to explore further an identified underground orebody immediately adjacent to the current open pit. Based on drilling results obtained to date Evolution is now considering options to further develop CGO over the Life of Mine, including additional open pit development and an underground mining operation. Evolution are firstly seeking to obtain an approval for the Underground Development Environmental Impact Statement (UG EIS), followed by obtaining subsequent approval for an open cut expansion development.

Large groundwater extraction rates from the Bland Creek Palaeochannel, near the CGO, are concentrated in three main areas. One of the areas encompasses the BCPB and ESB, both operated by Evolution as water supplies for the CGO. The other two areas encompass private bores. These areas are identified on the map in Figure 1-2. Each of the three areas has a monitoring piezometer used by the NSW government to monitor groundwater levels in the Lachlan Formation (at the request of the Bland Palaeochannel Groundwater Users Group) for groundwater management purposes. These piezometers have associated triggers defined by water levels at the piezometer. Operation of the BCPB and ESB is governed by water levels at monitoring piezometer GW036553. Should the bore water level at GW036553 fall to the trigger, various management actions for the BCPB and ESB would be initiated. The other two monitoring piezometers relate to groundwater usage at the Billabong and Maslin farm areas which are Figure 1-2. Breach of their trigger levels would initiate various management actions in those areas.

The objective of the modelling study presented in this report is to assess future water security of the mine by carrying out an assessment of drawdown impacts compared to set trigger levels, within the Bland Creek Palaeochannel. This comprises a study of potential impacts on groundwater levels and quality caused by future groundwater extraction from the BCPB and ESB for the underground development.

An assessment of impacts on the groundwater system at the area immediately surrounding the CGO was undertaken using a separate numerical groundwater flow model and is reported separately.

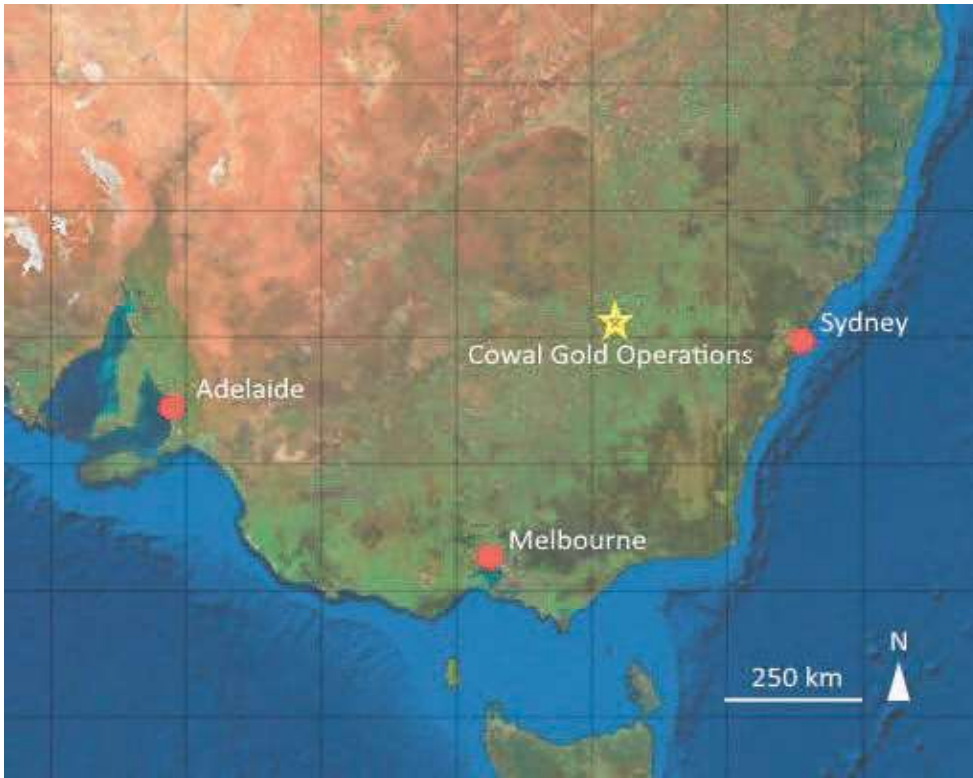

Figure 1-1: Cowal Gold Operations Location

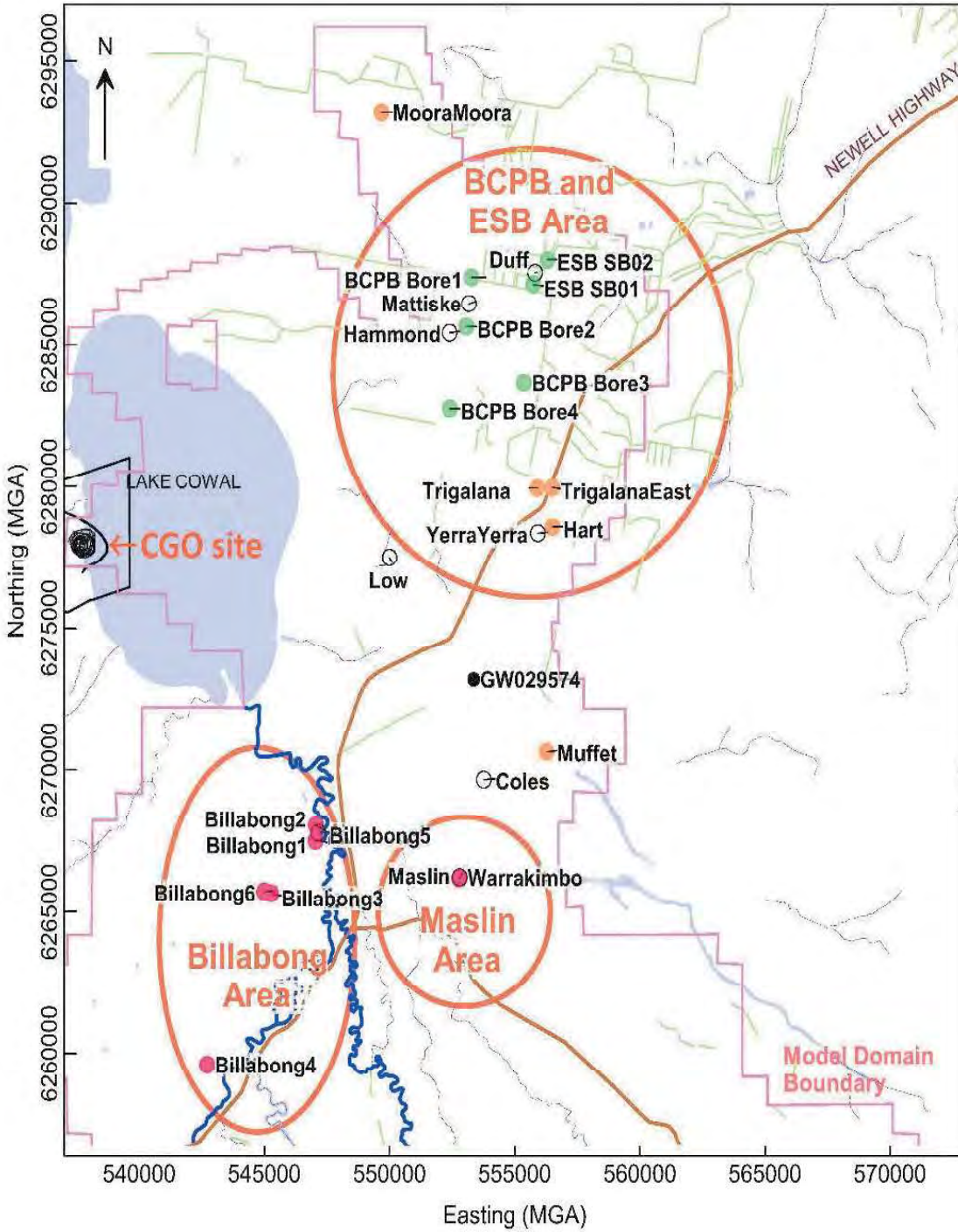

Figure 1-2: BCPB and ESB location in relation to the CGO

1.1. CGO Underground Development

The area of land to which the CGO Development Consent (DA 14/98) is relevant includes ML 1535, ML 1791, the CGO water supply pipeline and Bland Creek Palaeochannel Borefield. Open pit mining operations are currently undertaken within ML 1535, which encompasses approximately 2,636 hectares (ha). Evolution seeks to extend mining operations at the CGO by an underground development, which would be wholly contained within ML 1535.

The underground development proposal seeks for construction and operation of an underground mine at the CGO using stope mining practices, in addition to continuing operation of the existing open cut mine, to exploit an identified ore deposit in proximity (refer to Figure 1-3). Key features of the CGO Underground Development include:

- Extension of mine life from 2032 to 2040.
- A box-cut entry to the underground workings.
- A decline from the box-cut to provide access for personnel and maintenance.
- Six access points to the decline for access, ore haulage, ventilation circuit, underground services and emergency egress.
- A network of underground tunnels to provide access to the ore, transportation to the surface and ventilation.
- Use of sub-level open stoping to extract the ore.
- Production of up to 27 Mt of ore at a rate of 1.8 Mtpa.
- Production of approximately 5.74 Mt of waste rock.
- Stopes to be fully backfilled with paste material made from dewatered tailings and cement.
- A height increase from 245 m AHD to 246 m AHD to the final rehabilitated height of the integrated waste landform.
- Delivery of extracted ore and waste rock to the surface by truck.
- Development of a paste fill plant, and the delivery of paste fill via a borehole and then backfilling underground stopes with the paste.
- Development of ancillary underground infrastructure to support the underground operation, including dewatering infrastructure, ventilation system, electrical reticulation.

1.2. Approvals Strategy

To facilitate the underground development environmental impact assessment process, Evolution proposes to seek approval under the NSW *Environmental Planning and Assessment Act 1979* (EP&A Act) for two separate but inter-related applications:

- Underground workings EIS (UG EIS) – a State Significant Development (SSD) application under section 4.38 of the EP&A Act for the new underground component of the Underground Development.
- Surface changes modification – a request for modification (Modification 16) to the existing CGO development consent (DA 14/98) under section 4.55 of the EP&A Act for the ancillary surface changes associated with the Underground Development.

1.3. Secretary’s Environmental Assessment Requirements

The Secretary’s Environmental Assessment Requirements (SEARs) for the UG EIS (provided on 27 September 2019) included the following requirements related to groundwater:

- An assessment of the likely impacts of the development on the quantity and quality of regional surface water and groundwater resources.
- An assessment of the likely impacts of the development on aquifers, watercourses, riparian land, water-related infrastructure, and other water users.
- Water supply arrangements for the development.

The SEARs also include policies, plans and guidelines, which have been considered during the preparation of this report (refer to Section 2).

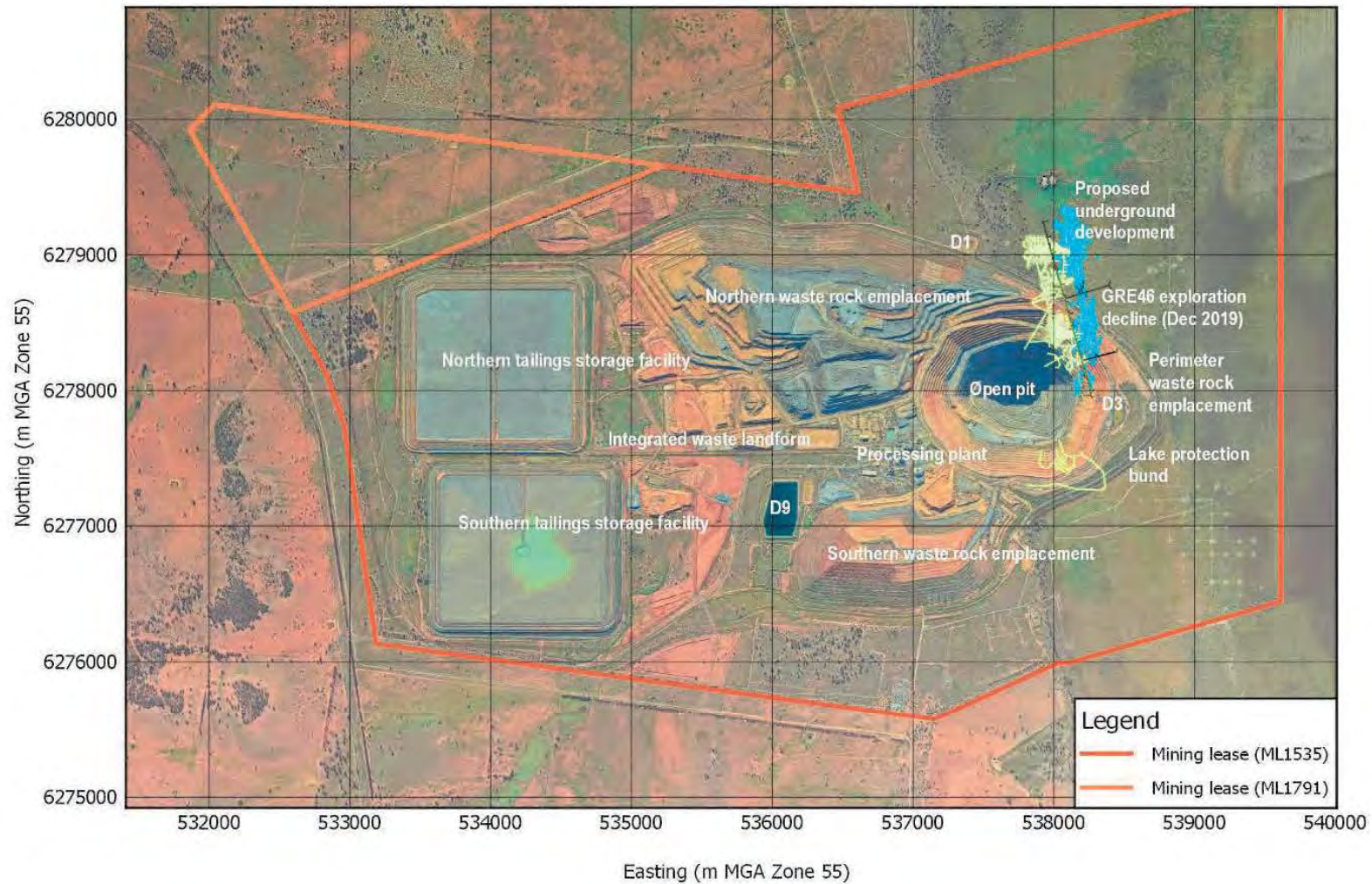

Figure 1-3: Proposed Underground Development

2. Legislation, Policy and Guidelines

This assessment has been prepared with consideration of the following policies, guidelines and plans:

- National Water Quality Management Strategy Guidelines for Groundwater Protection in Australia (Australian and New Zealand Environment and Conservation Council, 1995).
- NSW Protection of the Environment Operations Act 1997.
- NSW State Groundwater Policy Framework Document (NSW Department of Land and Water Conservation [DLWC], 1997).
- NSW State Groundwater Quality Protection Policy (DLWC, 1998).
- NSW Groundwater Dependent Ecosystem Policy (DLWC, 2002).
- NSW Aquifer Interference Policy (NSW Department of Primary Industries Office of Water, 2012).
- Water Sharing Plan for the Lachlan Unregulated and Alluvial Water Sources – Background document for amended plan 2016 (NSW Department of Primary Industries Water, 2016).
- Australian Groundwater Modelling Guidelines (Barnett et al., 2012).
- Guidelines for the Assessment and Management of Groundwater Contamination (Department of Environment and Conservation NSW, 2007).

3. Previous Studies

In 2006 Coffey developed a three-dimensional numerical groundwater flow model for assessing the impacts of pumping from the BCPB on the surrounding environment and other groundwater users (Coffey, 2006). This was calibrated and used for predictive analysis. In 2010, due to changes in the mine plan and the introduction of the ESB, the model was upgraded and used to assess the impacts from proposed future changes in pumping from the BCPB and ESB. The 2010 upgrade comprised the following:

- Division of the Cowra formation into two model layers (the Upper and Lower Cowra Formations), forming a 3-layer model (with the bottom layer representing the Lachlan Formation as before), so pumping from the Cowra Formation could be simulated in more detail.
- Inclusion of the ESB (production bores SB01 and SB02).

Due to the inclusion of an additional layer in the model and to ensure that the model is continually updated, the model was recalibrated at the time of the upgrade. This task included the addition of new pumping and monitoring records collected since 2006.

Predictive simulations were undertaken in 2013, 2016 and 2017/2018 (Coffey 2013, 2016, 2018). The current assessment builds upon the previous work which assessed the impacts of the mining operations in relation to changes to the CGO associated with the approved Mine Life Extension modification.

The work undertaken in the current study uses the existing recalibrated model to simulate potential impacts on the groundwater system from operation of the BCPB and ESB due to the Underground development. It incorporates additional BCPB pumping measurements, and additional monitoring piezometer measurements, collected between 2017 and 2019. Refer to Coffey (2013) for a detailed description of the numerical model and the recalibration undertaken in 2010.

4. Site Characteristics

4.1. Topography

The region is characterised by a flat landscape with low undulating hills and occasional rocky outcrops. The majority of vegetation in the area has been cleared, with most of the cleared areas used for agriculture. Remnant and secondary vegetation is restricted to elevated rocky areas (SNC Lavalin Australia, 2003).

Figure 4-1 shows the topography and drainage of the area. Ground slopes fall from the north east (Lachlan Floodplain) and south east (upper Bland Creek Palaeochannel) towards Lake Cowal. Lake Cowal forms a local depression and fills with flood water every few years. It drains north west towards Nerang Cowal, and eventually to the Lachlan River. Breakout flows from the Lachlan River at Jemalong Gap drain towards Lake Cowal.

Ground elevations at the CGO range from around 225 metres Australian Height Datum (m AHD) on the western lease boundary to about 200 m AHD at the eastern lease boundary within Lake Cowal. The BCPB area has an elevation of just under 210 m AHD, with minimal variation. Hills formed by rock outcrops on the fringes of the Bland Creek floodplain reach to in excess of 300 m AHD.

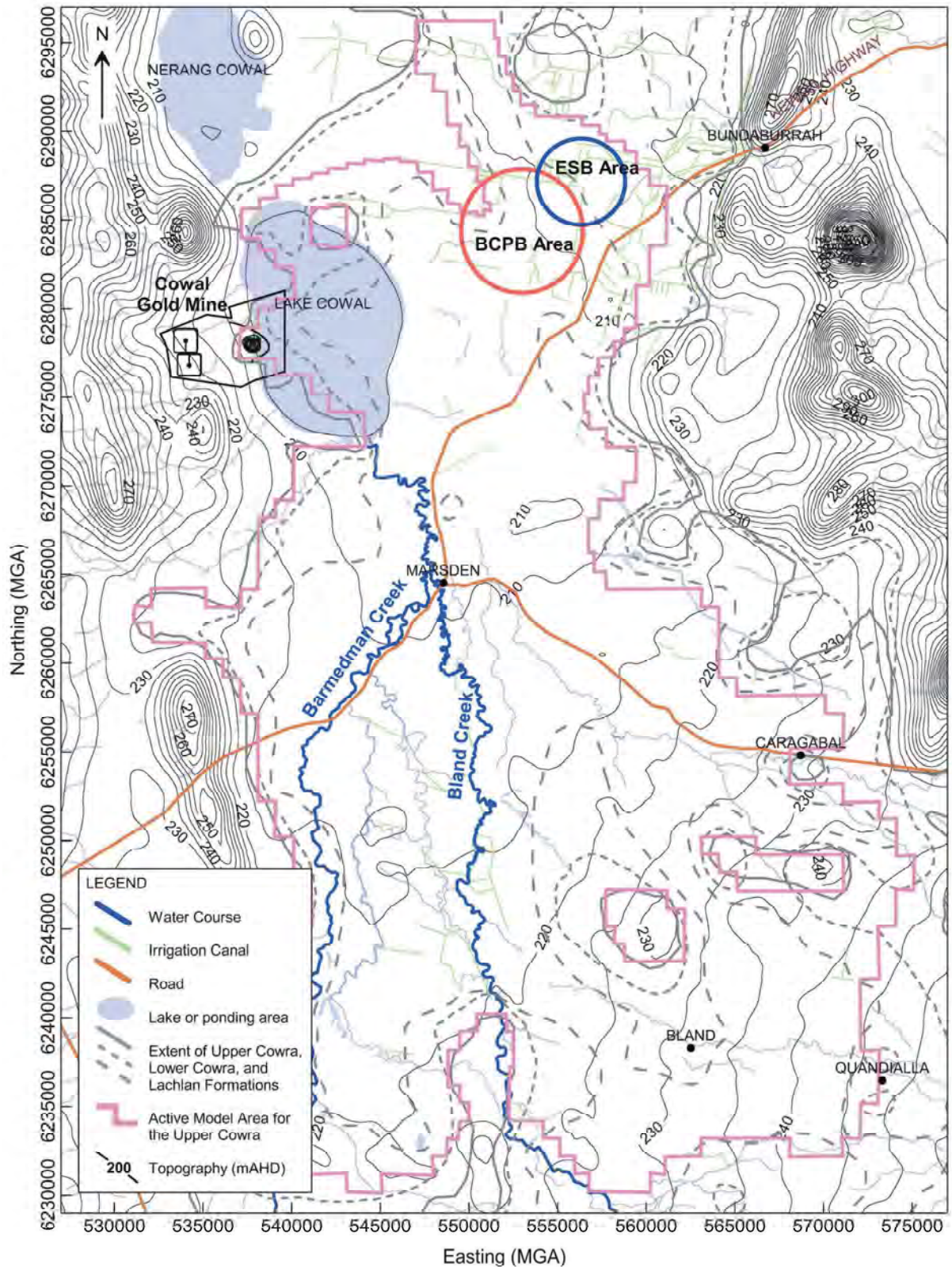

Figure 4-1: Regional topography

4.2. Climate

4.2.1. Regional Averages

The closest rainfall station to the study area with long-term records is Bureau of Meteorology (BoM) Station 73054 (Wyalong Post Office), located south of ML 1535, in the western part of the Bland Creek Palaeochannel. The closest climate station within 100 km of the site with reasonable amounts of pan evaporation data (from 1973 to 2019) is BoM Station 050052 (Condobolin Agricultural Research Station), located about 65 km to the north west of the BCPB. Table 1 lists average rainfall at station 73054 (1895 to 2019) and average monthly pan evaporation at station 050052. For average conditions, a rainfall deficit occurs for all months of the year.

Table 1: Average rainfall and pan evaporation in the regional area

Month	Mean rainfall (millimetres [mm]) at Wyalong Post Office (73054)	Mean pan evaporation (mm) at Condobolin Agricultural Research Station (050052)
January	41.2	313.1
February	38.2	246.4
March	38.1	210.8
April	34.0	129.0
May	39.0	74.4
June	43.0	48.0
July	41.6	49.6
August	38.4	77.5
September	36.8	117.0
October	44.3	182.9
November	36.7	234.0
December	43.9	297.6
Annual	475.2	1972.4

4.2.2. Mine Site Rainfall

Daily rainfall data is available for the period 2004 to 2019 inclusive from the CGO site weather station. The monthly site rainfall has been correlated with annual rainfall from Bureau of Meteorology (BoM) stations 73054 (Wyalong Post Office) and 50017 (West Wyalong Airport). A study was carried out for the period 2004 to 2015 to check the correlation between rainfall at these locations. More recent data is generally consistent with the correlation indicated. Figure 4-2 illustrates the correlations.

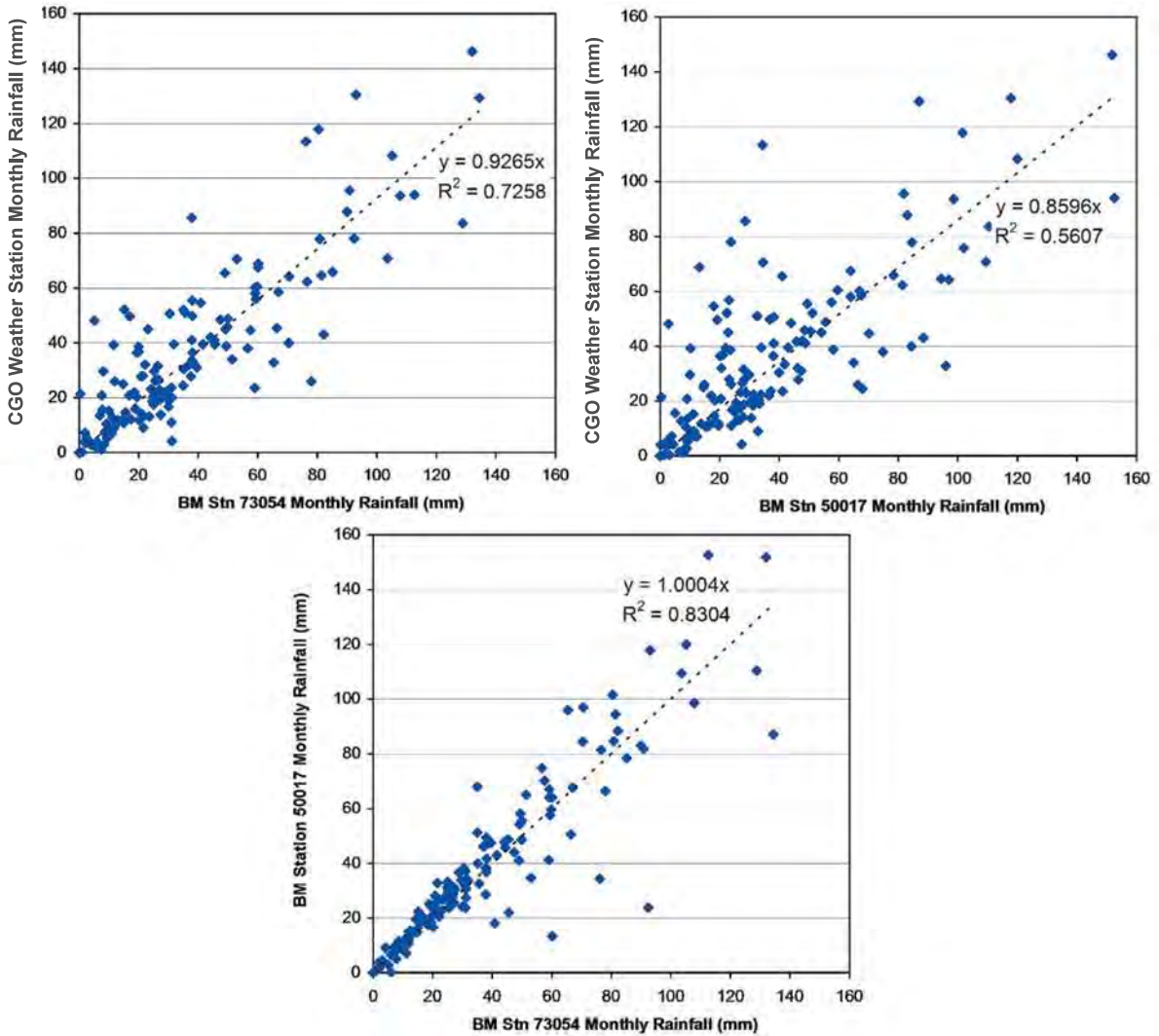

Figure 4-2: Correlation of monthly rainfall from the CGO site weather station with two BoM stations for 2004 to 2015 inclusive

CGO site rainfall correlates reasonably with station 73054 but less so with station 50017. The residuals normality for station 50017 with the CGO site and station 73054 is poor. CGO site monthly rainfall is an average of 93% of station 73054 rainfall. By corollary, the long-term average annual rainfall at the CGO site is estimated to be 444 mm.

4.3. Surface Drainage

The main water courses in the BCPB area are Bland and Barmedman Creeks (Figure 4-1). These are ephemeral and drain into Lake Cowal (also ephemeral), from the south. An extensive irrigation canal system is also present at the BCPB area and to the north. These canals deliver water to irrigators to sustain the local agricultural industry.

Flow gauging data from government flow gauge 412103 (Bland Creek at Morangarell) was available for the period 1976 to 2003. This gauge has a catchment area of 3,110 km² and is located in the Burragorang Palaeochannel, about 10 km south of the southern boundary of the modelled area. A review of the flow data for this period indicate the following:

- No flow for 61% of the period (the minimum measurable flow is 0.1 ML/day).
- An average flow over all days of 117 ML/day.
- An average flow over all days of measurable flow (39% of the period) of 298 ML/day.
- A maximum recorded flow of 17,854 ML/day (on 27 July 1993).

A baseflow analysis was undertaken for flow data from gauge 412103 using the local minimum method, implemented using the program BFI and the procedure of Wahl and Wahl (1995). This implementation is based on the deterministic procedure proposed by the British Institute of Hydrology (1980a, 1980b). Using this method, baseflow is estimated by analysing the minima in streamflow time series when partitioned into N-day periods. Unlike filtering methods, the local minimum method cannot calculate baseflows that are greater than streamflow and makes no assumptions about recession character. Based on experience, and the preferred use of the method by overseas agencies, this method is considered superior to filtering for extraction of baseflow magnitudes. Results of the analysis indicate that baseflow was an average of 0.3% of rainfall between 1977 and 2000.

Lake Cowal is an ephemeral shallow freshwater lake that is filled by runoff from the Bland Creek catchment to the south and flood breakout from the Lachlan River to the north east. The pit envelope impedes on the lake area, and a lake protection bund and dewatering programme form an integral part of the mine plan. At the overflow (full storage) level of about 205.7 m AHD the lake overflows into Nerang Cowal, another ephemeral lake to the north, and then into Bogandillon Swamp before returning to the Lachlan River. The base of the lake is at about 201.5 m AHD. Figure 4-3 shows available lake water level observations compared to flow at gauge 412103. When the lake is draining, water levels show a quasi-logarithmic fall. Below the full storage level, the rate of water level fall is approximately linear with time. An analysis of eight recession events was undertaken. For each event, the time period was selected such that other data suggest negligible inflows to the lake from creeks and surface runoff were occurring. For each event, pan evaporation and direct rainfall to the lake water body were taken into account. The average fall in lake water level (accounting for rainfall) from the events was equal to 80% of pan evaporation. This is similar to recorded rates of water level fall for large shallow lakes that contain suspended and dissolved solids in a semi-arid climate. Results indicate that transfer of groundwater to or from Lake Cowal is low, with the precision of the results being less than that required to quantify the transfer.

Irrigation canals are extensive and most of their combined reach appears to be unlined. These channels serve as artificial water courses to deliver water for local agriculture but are ephemeral (they are mainly used during the growing season). One of the main channels in the area (the Warroo channel) has been reported as suffering losses through seepage from the channel base (Van der Lely, 1993), estimated at around 2,000 ML/year but potentially ranging between 500 and 6000 ML/year.

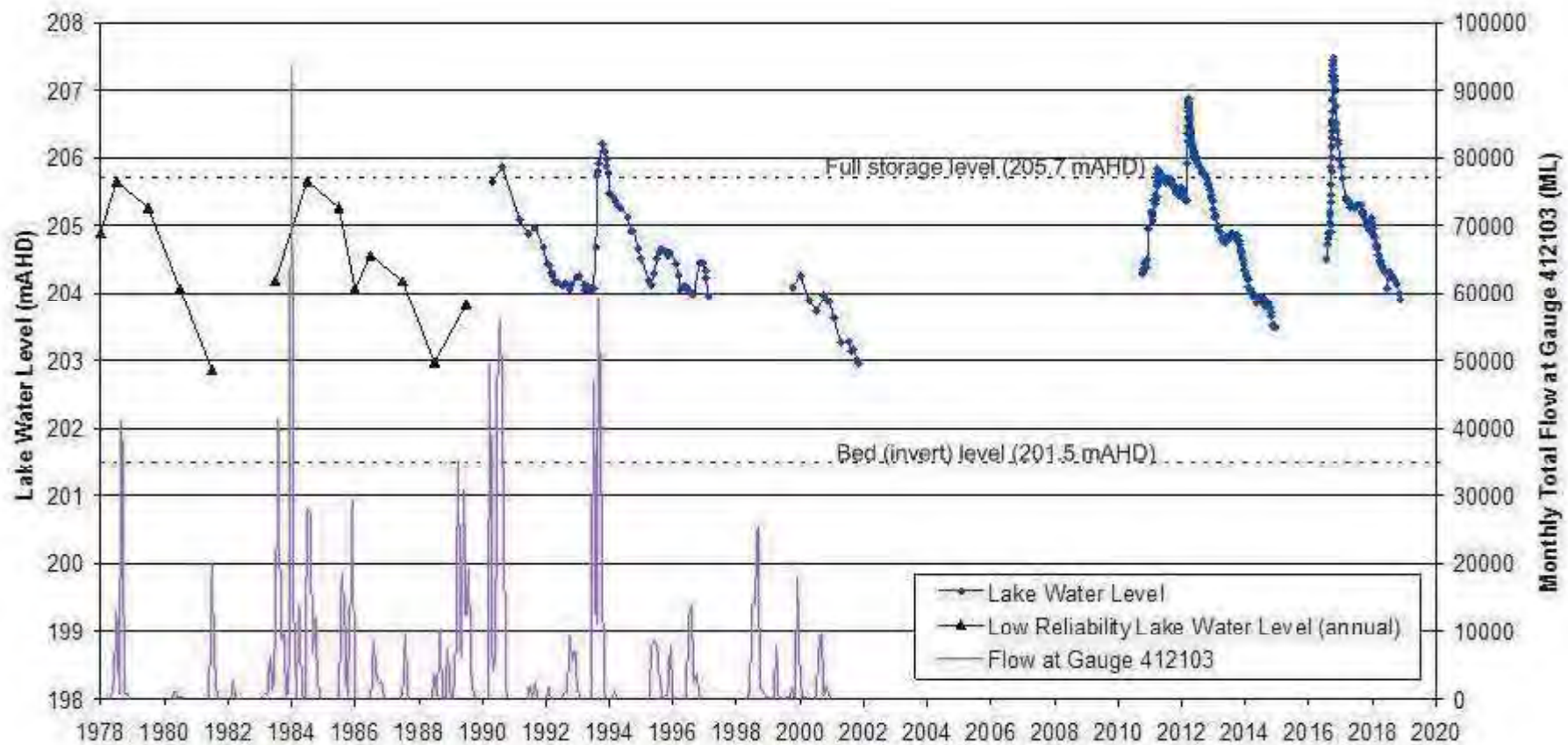

Figure 4-3: Observed water levels in Lake Cowal and flow at gauge 412103

4.3.1. Recharge to the Water Table

Studies of groundwater chemistry in the Bland Creek Palaeochannel (Carrara et al., 2004) indicate that the Thuddungra region is a recharge area for the Lachlan and Cowra Formations. Results also suggest that the Lachlan Formation shows a generalised preferential lateral groundwater flow system, without significant vertical recharge except in the Thuddungra region. In contrast, results suggest that the shallow part of the Cowra Formation comprises a system where recharge to the groundwater system is dominated by vertical infiltration at the surface, and lateral groundwater flow is limited and local.

Anderson et al. (1993) estimated that recharge through the base of stream channels and over-bank flooding are the dominant recharge processes in the Lachlan Valley. The amount of recharge provided by this process in the Bland Creek Palaeochannel is difficult to assess due to the impact of pumping on groundwater monitoring hydrographs. Minor flooding occurs intermittently in the palaeochannel area, however surface sediments in this area are less permeable than further north in the Jemalong / Wyldes Plains Irrigation District and the main Lachlan Valley, likely resulting in lower recharge from this source compared to the Lachlan Valley.

Coffey (1994) estimated a total accession rate (irrigation deep drainage and rainfall infiltration) to the groundwater system, from numerical model calibration, of between nil and 18 millimetres per year (mm/year) for the Upper Cowra Formation in the Jemalong / Wyldes Plains Irrigation District. The higher infiltration rates were restricted to a 10 km-wide zone south of the Lachlan River. The overall average calibrated recharge to the Upper Cowra Formation between Lake Cowal and the Lachlan River was around 10 mm/year or around 2% of average rainfall.

Ross (1982) estimated that 1.25% of rainfall accedes to the groundwater system in the low salinity groundwater areas of the Upper Lachlan Valley.

Williams (1993) estimated that long-term increases in groundwater storage in the Upper Cowra Formation in the Jemalong / Wyldes Plain Irrigation District were a minimum of about 5.2 mm/year (about 1% of incident rainfall, assuming a refillable void space of 5% at the water table). Results did not allow separate identification of contributions made by flooding, rainfall, and irrigation.

Cook et al (2001) estimated rainfall recharge over agricultural land of the Mallee region near the Murray River (average rainfall 300 to 400 mm/year). Results indicated deep drainage rates varying between 3 mm/year (0.9% of annual rainfall) and 30 mm/year (9% of annual rainfall) at crop rotation sites with average clay contents in the upper 2 m of the surface soil profile varying between 30% and 2% respectively.

Numerical modelling by Williams (1993) for the upper 20 m of the Cowra Formation indicated that evaporation from surface ponding caused by groundwater seeps was occurring in several locations in the more topographically depressed area in the vicinity of the Corinella Constriction.

Hydrograph Analysis for the BCPB Area

With the area characterised by high rates of irrigation, an assessment was undertaken for the area east of Lake Cowal to estimate zones where recharge to the water table is likely to be controlled mainly by rainfall or irrigation. This was the only area in the model domain where significant amounts of water table hydrographs were available (from monitoring piezometers maintained by Jemalong Irrigation Limited, for the period 1994 to 2006).

The assessment compared piezometer hydrographs to the cumulative monthly rainfall residual. Hydrographs showing a significant correlation with the rainfall residual were classified as being influenced mainly by rainfall. Irrigation may still have been active in these areas however its influence was interpreted as secondary. Hydrographs showing a characteristic trend of rise during dry conditions were classified as irrigation dominated.

Figure 4-4 shows the results of the assessment. Piezometer names are a single number. The pattern identifies the area where irrigation is affecting the water table. Recharge will thus vary across the area. Areas with irrigation-dominant recharge may have larger groundwater recharge. The numerical model adopts a single average rate which takes into account the irrigation process, however further south there are fewer tracts of land that are irrigated. Irrigation practices add a degree of approximation to the recharge rate used in the model.

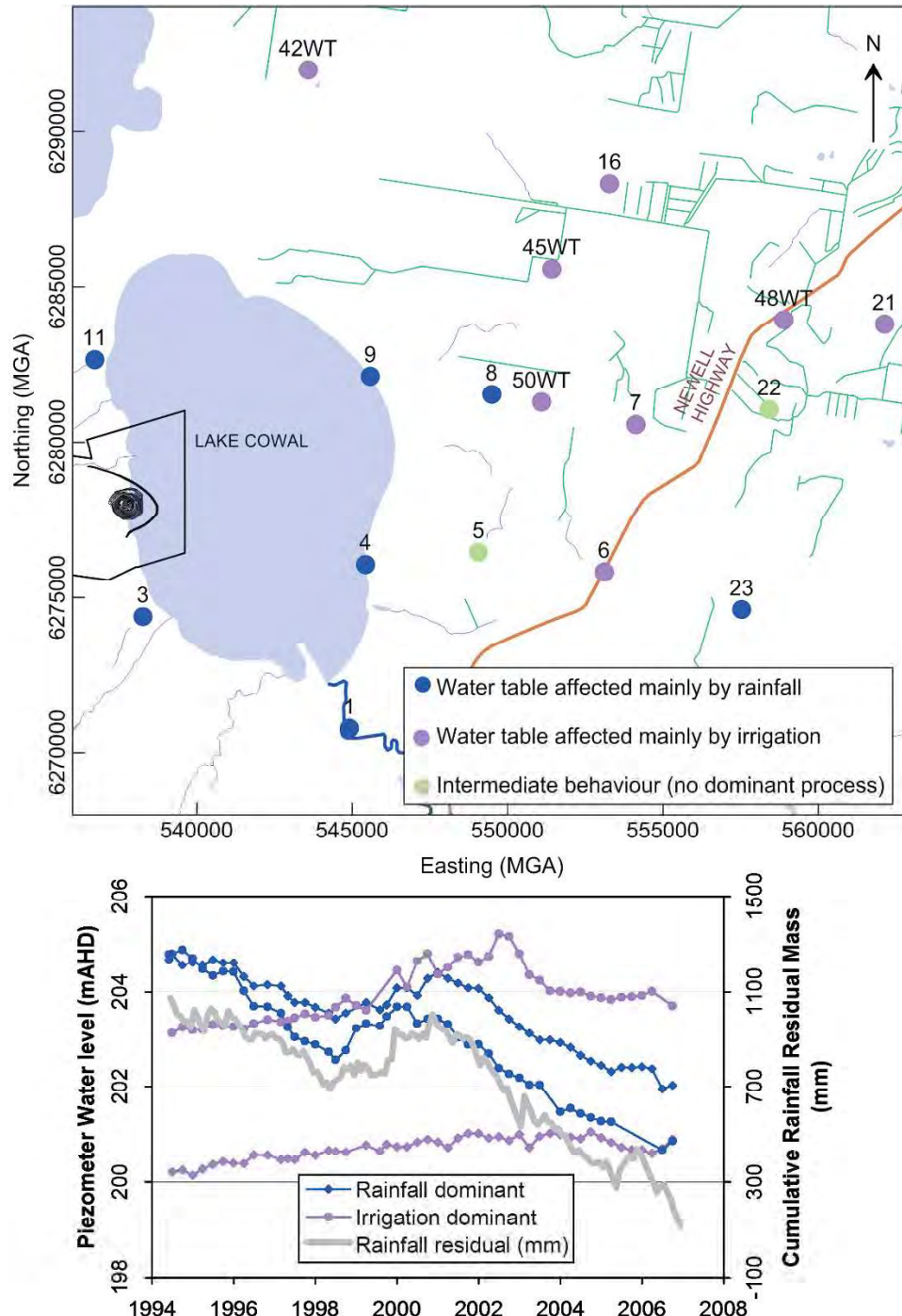

Figure 4-4: Spatial relationship of water table piezometers (maintained by Jemalong Irrigation Limited) classified according to the dominant influence on their hydrographs. Numbers at piezometer locations are their names

4.4. Geology

A detailed discussion of the geology of the area is made in Coffey (2013). A summary is provided below.

The alluvial sequence in the study area consists of the Cowra Formation and the underlying Lachlan Formation. The Lachlan Formation is the main aquifer in the study area. The Cowra Formation has lower hydraulic conductivity and higher groundwater salinity.

The Cowra Formation comprises predominantly stiff red/yellow/brown high plasticity clay (grading to grey at depth) with intermittent sand and silt horizons. The base of the Cowra formation is generally marked by a conspicuous multi-coloured clay layer. Geophysical (gamma) logs and hydraulic test data for bores in the vicinity of the BCPB suggest that the Cowra Formation can be divided into upper and lower sequences. The base of the Upper Cowra sequence is assessed to be at about 47 m below ground level at the BCPB.

The Lachlan Formation consists of light grey fine to coarse-grained sand and fine to medium gravel, mostly composed of smoky quartz, chert, and wood fragments. The Lachlan Formation is underlain by bedrock. Between 2 m and 5 m of clay lies between the base of high hydraulic conductivity sediments in the Lachlan Formation and the top of bedrock, however in some places the clay is absent. The clay is interpreted to consist mostly of residual weathered product of underlying rocks. The modelled extent of the Lachlan Formation includes lower hydraulic conductivity sediments surrounding the high permeability sands and minor gravels in the deeper parts of the palaeochannel. The high hydraulic conductivity sands and minor gravels appear to be located adjacent to steep bedrock surface gradients within the deeper parts of the palaeochannel. The spatial variation in high and low conductivity sediments in the Lachlan Formation indicates that the high conductivity part of the Lachlan Formation bifurcates just north of Marsden.

A constriction in the bedrock surface occurs to the north of the BCPB at Corinella and is referred to as the Corinella Constriction.

4.5. Subsurface Hydraulic Properties

4.5.1. Hydraulic Conductivity

For previous studies, a large database was compiled of hydraulic conductivity measurements from in-situ hydraulic testing. The database consists of the following:

- 26 single rate pump tests conducted at the CGO.
- Three packer tests in volcanic rocks conducted at the CGO.
- Two long-term single rate pump tests conducted at the two saline borefields (at other sites).
- Six long-term single rate tests conducted at the BCPB.
- 102 estimates of hydraulic conductivity from specific capacity data in government records for private water bores. 45 estimates are for the Lachlan Floodplain (north of the Corinella Constriction). Appendix A shows the method used to obtain hydraulic conductivity from specific capacity.

Figure 4-5 shows the hydraulic conductivity database developed from these measurements.

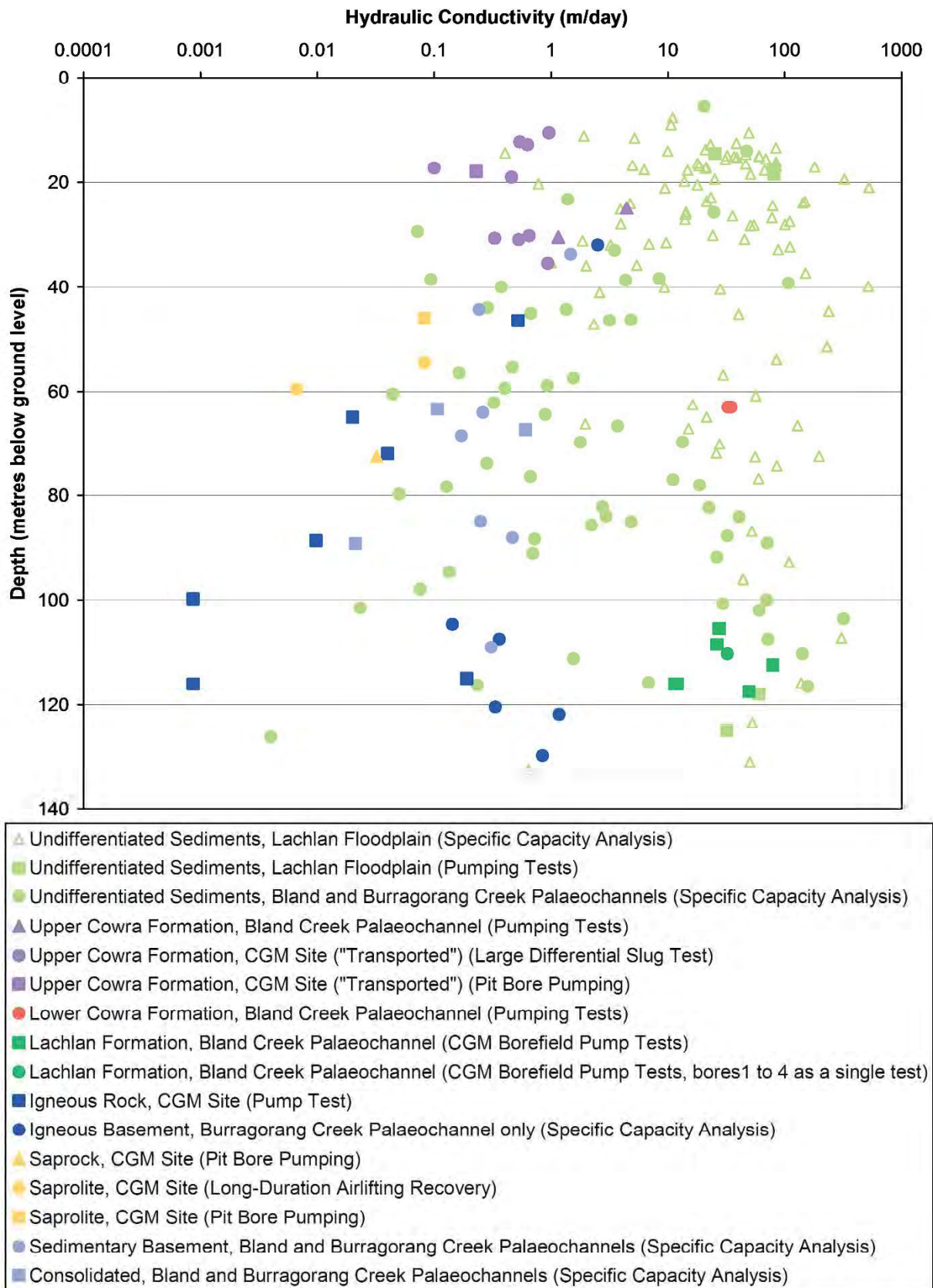

Figure 4-5: Hydraulic conductivity database for the Bland Creek Palaeochannel area

Three distinct alluvial sequences are interpreted to be present. These are as follows:

- Upper Cowra Formation. This sequence generally occurs from ground surface to an average depth of around 45 m to 50 m. The average depth to groundwater is around 7 m, giving an average saturated thickness of just over 40 m. This sequence generally shows decreasing hydraulic conductivity with depth.
- Lower Cowra Formation. This sequence generally occurs over an average depth interval of around 50 m to 90 m over most of the study area. This layer appears to have different hydraulic properties to the Upper Cowra formation.
- Lachlan Formation. This sequence generally occurs over an average depth interval of around 90 m to 120 m in the Bland Creek Palaeochannel and between 75 m and 110 m in the Burratorang Palaeochannel. Within this formation, two distinct sequences are interpreted as follows:
 - High hydraulic conductivity sands and minor gravels close to and within the deeper parts of the palaeochannel. This sequence has a geometric mean hydraulic conductivity of about 30 metres per day (m/day).
 - Lower hydraulic conductivity sediments generally occurring further away from the deeper parts of the palaeochannel and surrounding the high hydraulic conductivity sands and minor gravels. The hydraulic properties of this sequence appear similar to the Lower Cowra Formation.

The Bland Creek Palaeochannel basement consists mostly of sedimentary sequences (at burial depths exceeding 100 m). Igneous basement is present in the upper reaches of the Burratorang Palaeochannel. At the CGO, hydraulic conductivity of weathered and fresh rock follows a pattern of decreasing hydraulic conductivity with depth. Saprolite retains some of the original rock structure and can host open defects. The high hydraulic conductivity parts of the Lachlan Formation have a hydraulic conductivity approximately 100 to 1000 times larger than underlying bedrock. Bedrock at depth in the study area is considered to have significantly lower hydraulic conductivity than unconsolidated sediments except in structurally disturbed areas.

The bed of Lake Cowal is composed of a lacustrine clay layer of between 3 m and 8 m thickness. Hawkes (1998) reports an average vertical hydraulic conductivity of 5×10^{-7} m/day for the clay, from laboratory measurements on seven samples, and an average horizontal hydraulic conductivity of 6×10^{-5} m/day from three in situ hydraulic tests.

4.5.2. Storativity

No hydraulic test data were available from which an assessment of the specific yield of the Cowra Formation could be made. Williams (1993) estimated a value of 5% for the refillable void space at the water table in the Upper Cowra Formation in the Jemalong Plains Irrigation District. Surface sediments in that district are known to have a higher hydraulic conductivity than surface sediments in the Bland Creek Palaeochannel.

Results from hydraulic tests undertaken in 2004 in BCPB bores indicate an average storativity of 1.9×10^{-4} for the Lachlan Formation (Groundwater Consulting Services Pty Ltd (GCS), 2006). A pump test of seven days duration conducted at BLPR2 in 1995 (Coffey, 1995) indicated an average storativity of 1.7×10^{-4} for the Lachlan Formation. Assuming that confined processes provided the dominant influence on drawdowns during these tests (minimal drainage at the water table during the tests), the storativities are approximately equivalent to average specific storages of $9.5 \times 10^{-6} \text{ m}^{-1}$ and $8.5 \times 10^{-6} \text{ m}^{-1}$ respectively.

4.6. Groundwater Levels and Flow

4.6.1. Monitoring Network

Groundwater levels in the BCPB and ESB areas are monitored by Evolution using a network of standpipe piezometers as follows:

- BCPB: Piezometers BLPR1 to BLPR7.
- ESB: Piezometers PZ01 (decommissioned in 2012), PZ02, PZ05 to PZ11, and future pumping bores SB03 to SB05.

The NSW Department of Industry – Water (DIW) and Jemalong Irrigation Limited (JIL) also maintain extensive networks of standpipe monitoring piezometers in the area for various purposes.

Water level observations from the Evolution piezometers, and a selection of DIW and JIL piezometers, have been used in previous studies for assessment of the hydraulic head field, and numerical model calibration and verification. In selecting DIW piezometers, the following criteria were generally applied, to reduce the potential for unrepresentative measurements:

- Backfilling of 20 m or less from the base of the borehole to the bottom of the screen.
- Screens placed in separate boreholes.

Where multiple screens were installed in a single borehole, only the lowermost standpipe was selected, subject to the backfilling criterion and other factors.

The resulting network comprises 45 measurement points at 38 locations. Appendix B lists these piezometers and contains a map showing their locations. DIW monitors high-rate groundwater extraction in the area at piezometers GW036553, GW036597, and GW036611. These are fitted with automatic water level recorders.

For the current work, monitoring data from many DIW and JIL piezometers, and private water bores, was unavailable. Coffey sourced recorded water levels at DIW piezometers GW036553, GW036597, and GW036611, from the DIW internet-based data delivery system. The following sections summarise salient features of the hydraulic head field from before CGO operations commenced, using available information.

4.6.2. Hydrographs

Figure 4-6 shows hydrographs for the Upper Cowra, Lower Cowra, and Lachlan Formations in the BCPB area, using an approximately coincident set of monitoring piezometers throughout the vertical profile. They illustrate propagation of depressurisation at depth up through the profile. Increased groundwater extraction from the Lachlan Formation can be seen from the beginning of the drought in the 2000s. The vertical anisotropy of the sediments limits the upward propagation of depressurisation in the Lachlan Formation. The water table appears to remain unaffected over most of the record, however in this area, high volumes of irrigation are applied to the ground surface. The higher conductivity of the Lachlan Formation allows depressurisation from pumping to travel extensively in the lateral direction.

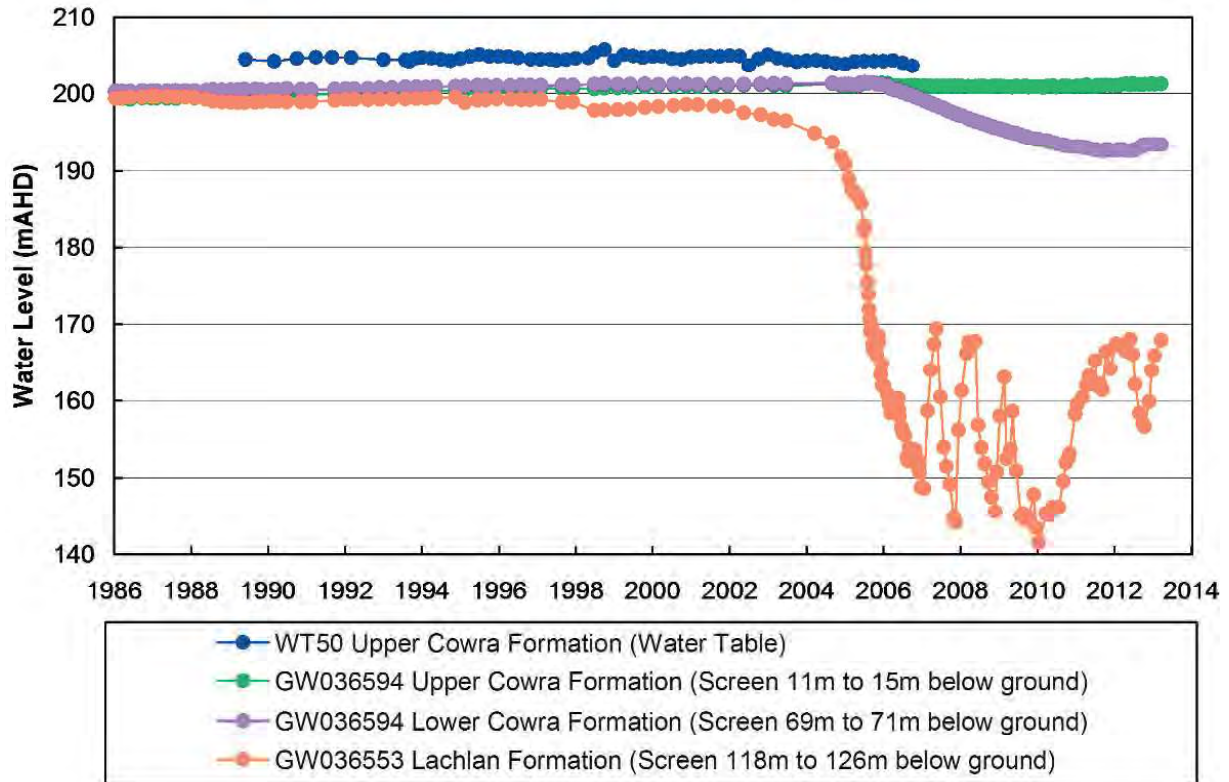

Figure 4-6: Hydrographs for approximately coincident piezometers in the BCPB area

Figure 4-7 and Figure 4-8 show water level observations for Evolution piezometers and GW036553 at the BCPB and ESB respectively, compared to total pumping, up to December 2019. The strong inverse correlation between piezometer water level and borefield pumping can be seen.

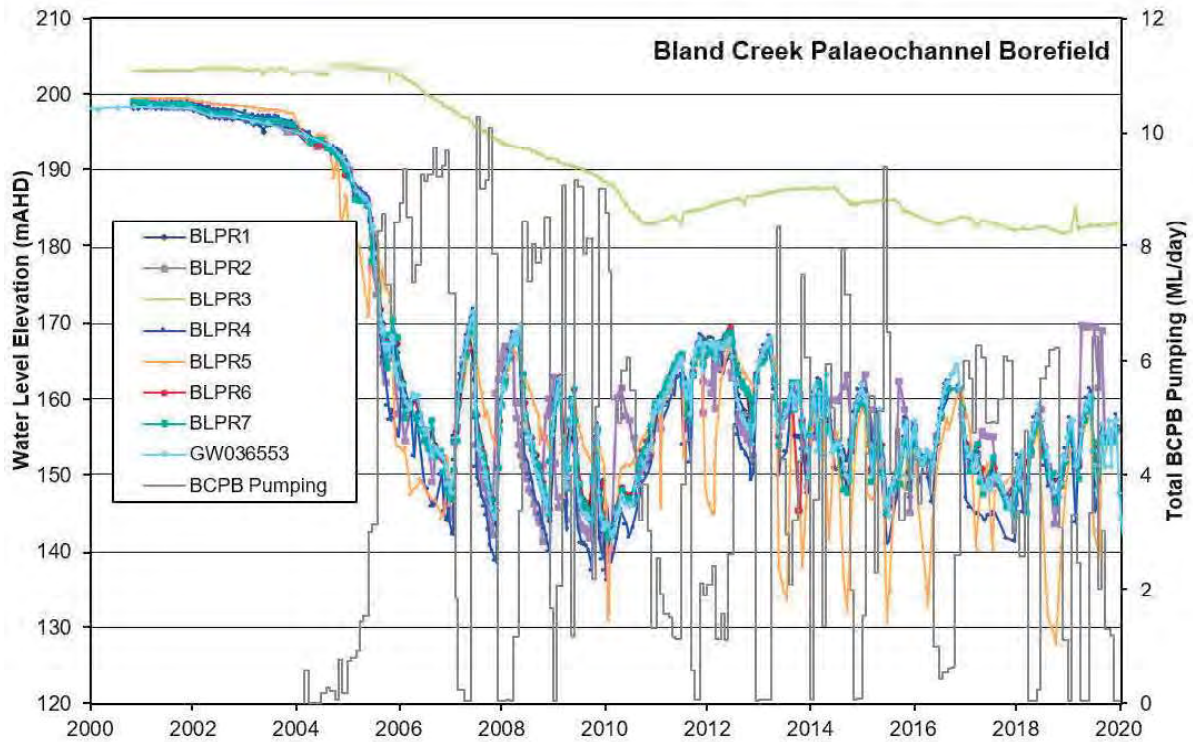

Figure 4-7: Monitoring piezometer hydrographs for the BCPB

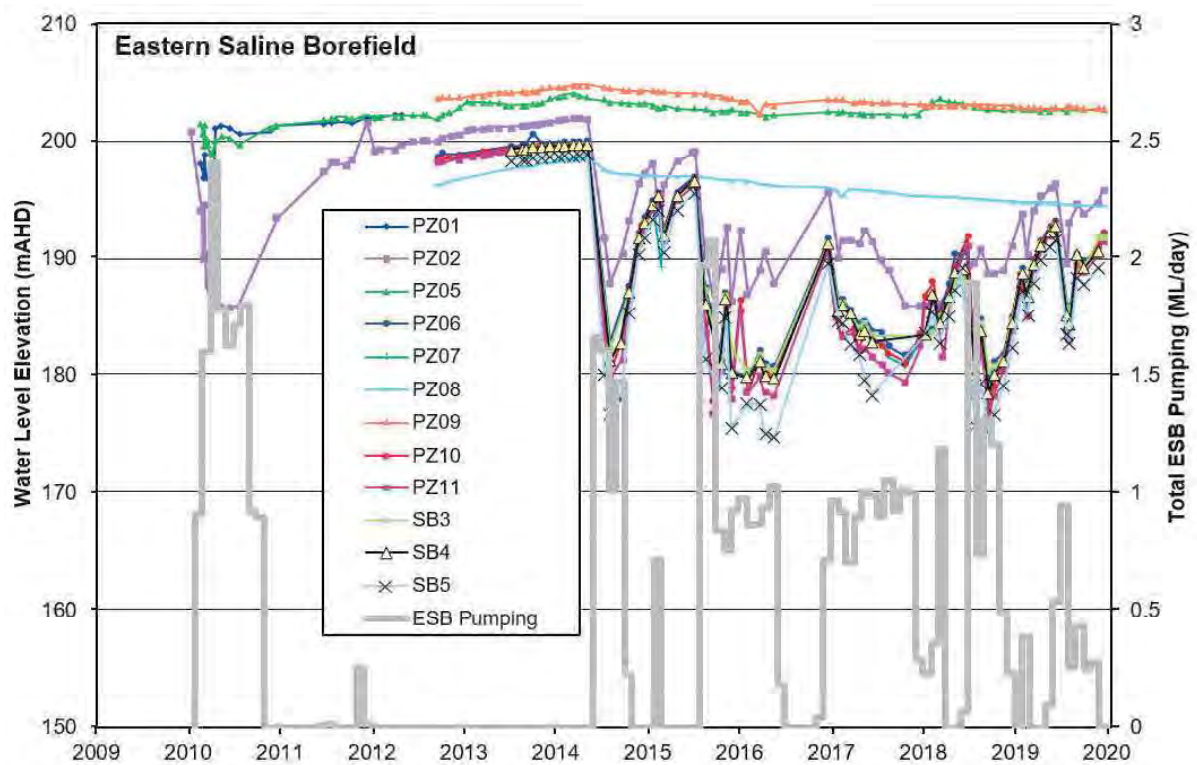

Figure 4-8: Monitoring piezometer hydrographs for the ESB

4.6.3. Hydraulic Head Surfaces

Available monitoring data has been used to interpolate hydraulic head surfaces for the Upper Cowra, Lower Cowra, and Lachlan Formations for December 1997 (prior to the commencement of significant pumping from the Lachlan Formation) and September 2006 (two years after commencement of the CGO). These surfaces are shown in Appendix C. The main changes in hydraulic head surfaces between these times are:

- The disappearance of the groundwater mound in the Upper Cowra Formation underneath Lake Cowal. The water level in Lake Cowal was probably at around 205 m AHD in mid-1998 (see Figure 4-3).
- The appearance of the drawdown cone around the BCPB.

The 1997 surfaces indicate overall westward groundwater flow. Trends in the Lower Cowra and Lachlan Formations suggest north-south structural features on the western side of the palaeochannel may play a part in groundwater drainage. The 2006 surfaces show the effects of significant pumping from the Lachlan Formation at the BCPB and in the Billabong Area. The time at which pumping started in the Billabong area is not known.

Water levels in the Upper Cowra Formation, where data are available, are an average of 5 m below ground level. Vegetation in the area is characterised by food crops and scrub plants, with root depths probably not deeper than 2 m below ground. Consumption of groundwater by evapotranspiration is therefore likely to be negligible, except at Lake Cowal, where water levels can rise to within the vicinity of the lake bottom during wet times.

Near the current mine pit, the Upper Cowra Formation shows some drawdown from drainage into the mine excavation, in conjunction with regional drawdown from drought conditions. This drawdown appears localised and is considered unlikely to significantly affect drawdown in the Upper Cowra, Lower Cowra, and Lachlan Formations further east (in the Bland Creek Palaeochannel).

4.6.4. Hydraulic Head Cross-Sections

Figure 4-9 and Figure 4-10 show interpreted hydraulic heads along a north-south cross-section running approximately through the middle of the model domain, for December 1997 and January 2010 respectively. Salinity corrections have not been applied to the water level measurements however the corrections are not considered necessary given the moderate salinity magnitude of the Upper Cowra, and the inverted salinity profile for the sediments (that is, salinity decreases with depth, which acts to slightly amplify the downward hydraulic head gradient in the Upper Cowra).

In December 1997, pumping from the Lachlan Formation was significantly lower than in subsequent years, since drought conditions had not yet developed. Hydraulic heads in the Lachlan Formation were similar to those in overlying strata, with gentle vertical gradients. The effect of drainage to the west is subtle but noticeable. Minor inflow from the Corinella Constriction appeared to be occurring. The BCPB and ESB were not active at this time.

The lowest hydraulic heads observed in the Lachlan Formation since monitoring began were observed in January 2010, when the BCPB and private bores were pumping at high levels from the Lachlan Formation. Several bore screens are more than 500 m from the cross-section, but their positions have been projected onto the cross-section. However, hydraulic head contours are for the cross-section itself, therefore the shape of the contours do not closely align with the bore screens. Significant vertical gradients are apparent in the Lower Cowra, in response to significant depressurisation in the Lachlan Formation. Hydraulic head gradients in the underlying rock are interpreted to be large, with minor upward leakage.

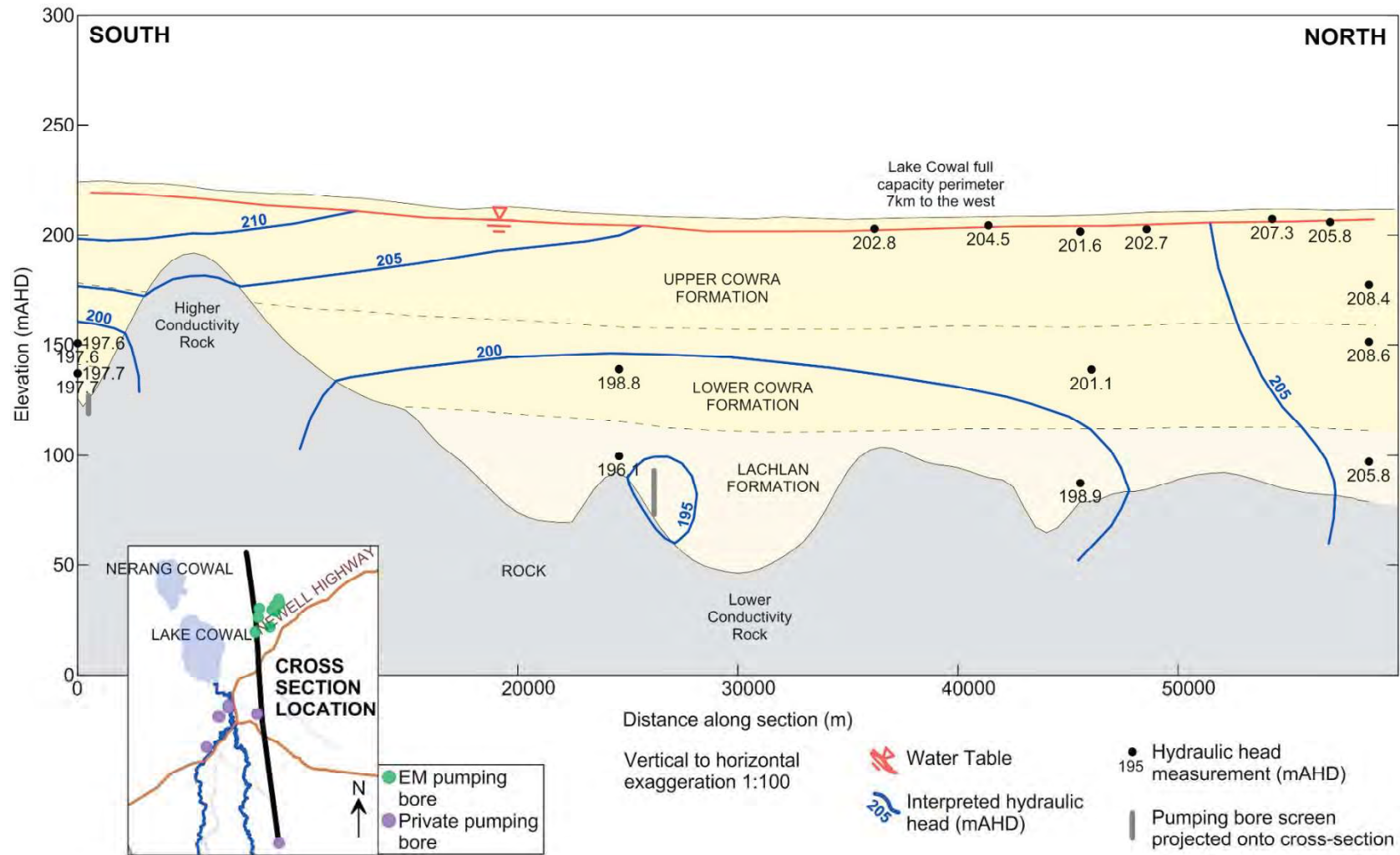

Figure 4-9: Interpreted hydraulic head cross-section for December 1997

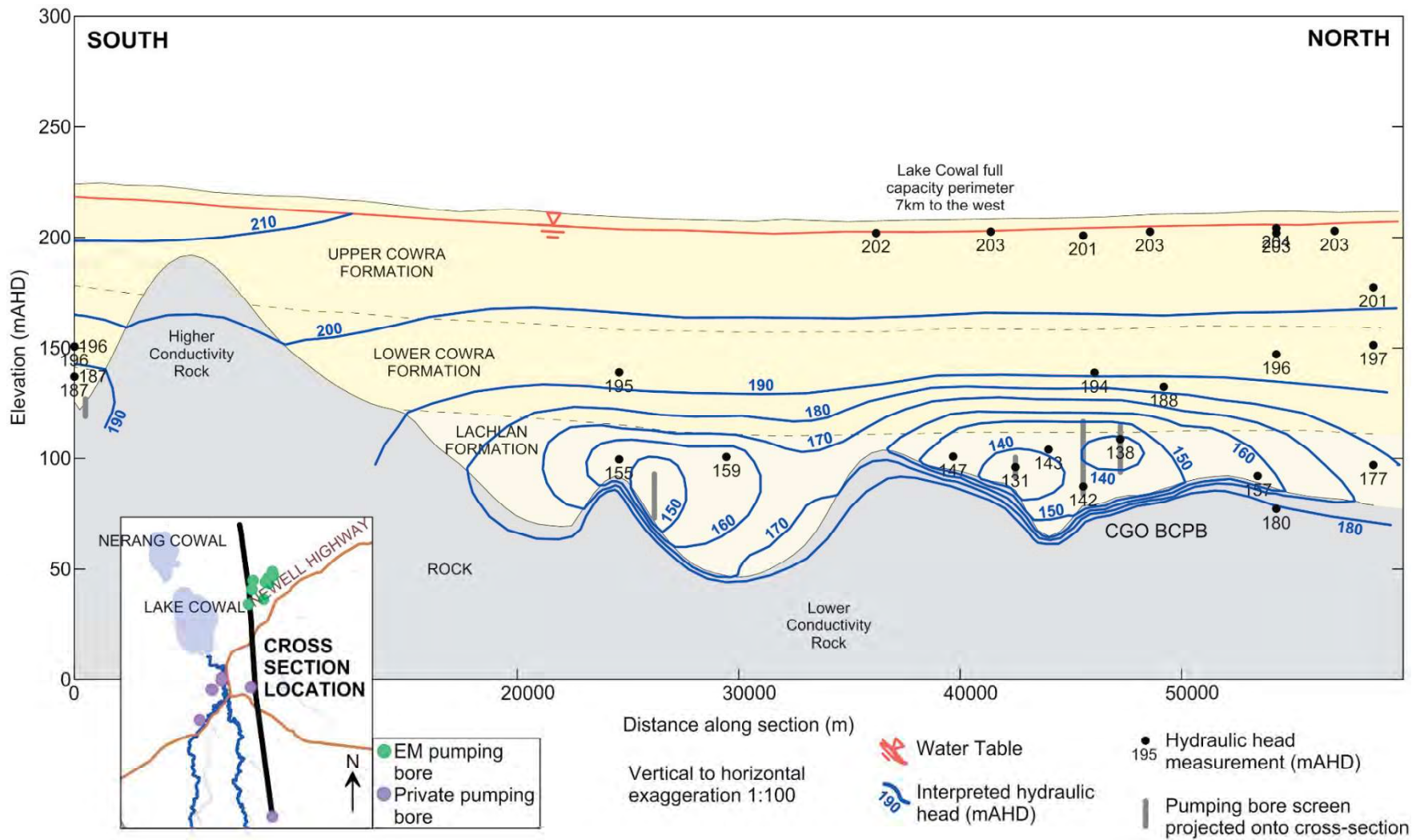

Figure 4-10: Interpreted hydraulic head cross-section for January 2010

4.7. Groundwater Salinity

Additional monitoring of groundwater electrical conductivity (EC) at the BCPB and ESB, obtained since 2013, has been combined with previously existing data. Figure 4-11 shows EC averages for piezometers in the database, versus depth. The database used in Figure 4-11 is listed in Appendix D.

Figure 4-11 indicates a strong trend of decreasing salinity with depth. The Cowra Formation is conspicuous above 80 m depth with greater salinities than the deeper Lachlan Formation. Near Lake Cowal, salinities in the Upper Cowra Formation are generally high (as are those in the Corinella and Lake Cowal cross-sections in Anderson et al., 1993).

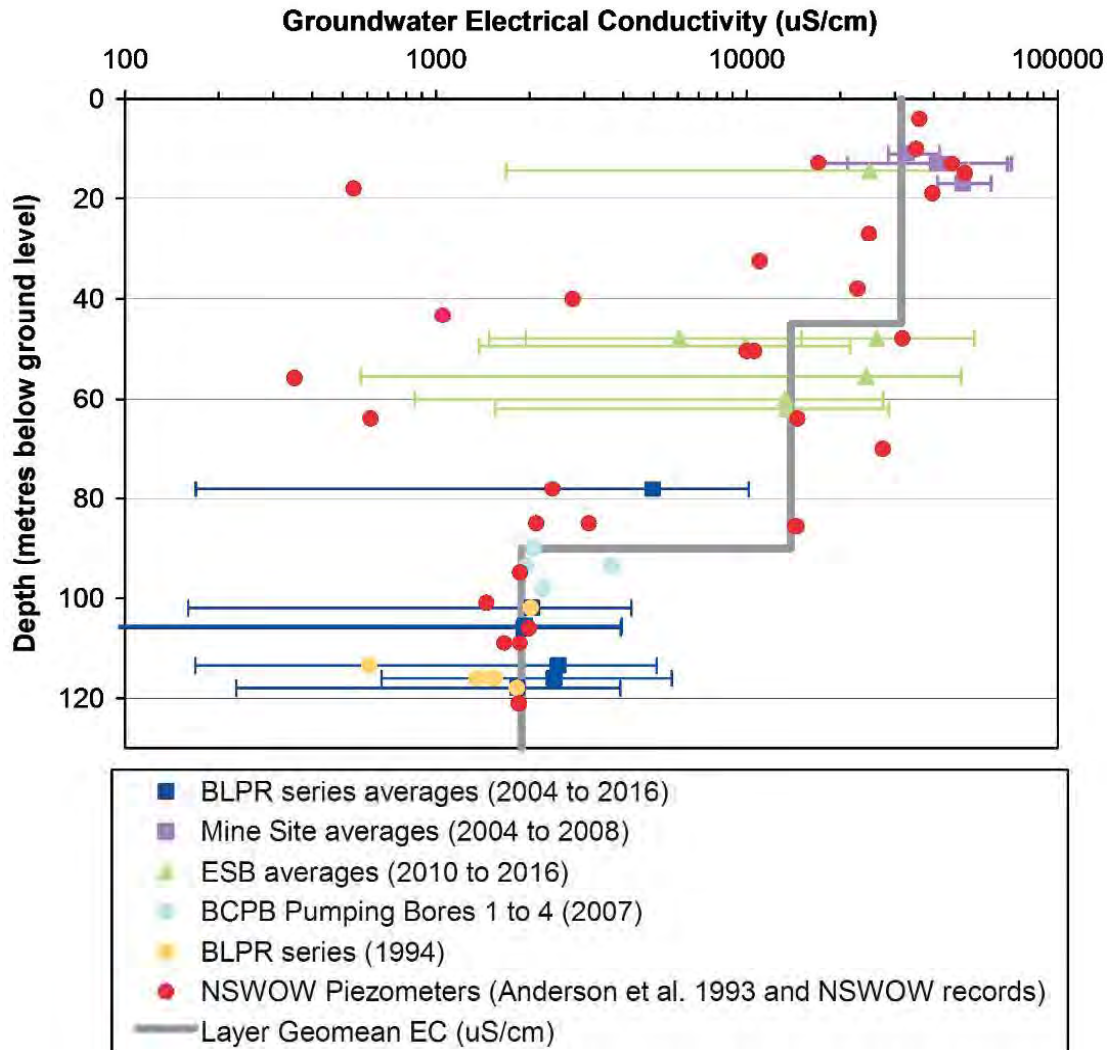

Figure 4-11: EC of groundwater in the regional area versus depth. Error bars indicate one standard deviation either side of the mean

Figure 4-12 shows field EC measurements from Evolution piezometers at the BCPB and ESB, up to December 2019, with instrumental measurement errors removed.

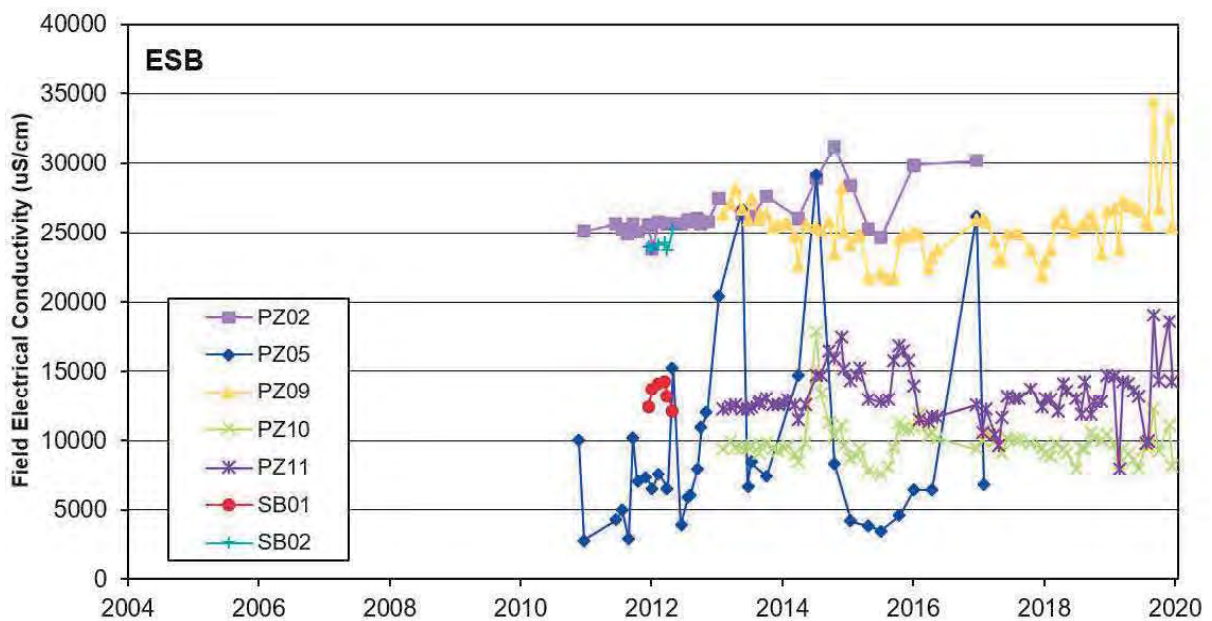
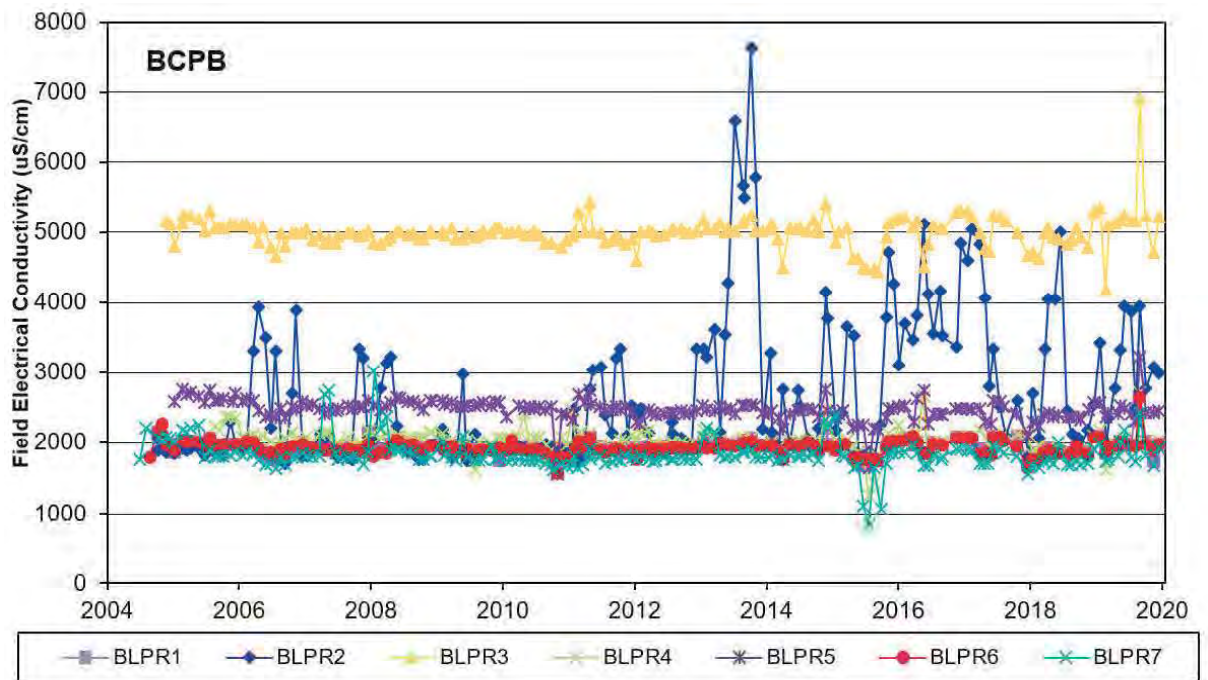

Figure 4-12: Groundwater EC versus time at Evolution monitoring piezometers

The data show an average salinity of around 2000 $\mu\text{S}/\text{cm}$ for the Lachlan Formation, except for BLPR3 (about 5000 $\mu\text{S}/\text{cm}$, screened in the Lower Cowra Formation). BLPR2 shows fluctuating measurements for which the cause is uncertain. Groundwater EC at the ESB is variable within the profile, adhering to the trend of decreasing EC with depth (see Figure 4-11).

4.7.1. Trend Analysis

Trends in Lachlan Formation EC at the BCPB were investigated by comparing an average EC dataset to BCPB pumping and the cumulative annual rainfall residual. The average EC dataset was compiled using observations from BLPR1, 4, 5, 6, and 7. First, observations at these piezometers were averaged over the length of record. Second, observations at BLPR4 to 7 were offset by an amount equal to the difference between a piezometers average and the average at BLPR1. This produced a dataset with observations referenced to the BLPR1 mean. The process is reasonable given the similarity in absolute value and first derivative between the piezometers.

Figure 4-13a shows the average EC time series compared to BCPB pumping and the cumulative annual rainfall residual. A weak relationship with the rainfall residual may be present, however given the characteristics of the groundwater system and the extraction horizon, a relationship recognisable over a 10-year period would be considered unlikely.

A more perceptible, but inverse, relationship with pumping appears to be present. Figure 4-13b shows the correlation between the derivative in EC and the derivative in BCPB pumping and identifies a non-negligible inverse relationship. Since vertical flow velocities (from the Lower Cowra Formation into the Lachlan Formation) are likely to be significantly smaller than lateral flow velocities within the Lachlan Formation, the variation in pumping rate is thought to act by laterally attracting transient pulses of more distant lower EC Lachlan Formation groundwater (where downward vertical head gradients are smaller) into the immediate BCPB area, during pumping rate build-up, and thereby removing the slower build-up of higher EC groundwater seeping down from the Lower Cowra Formation. This supports the probable dominance of advective processes in solute transport in the system (Coffey, 2016). This process would imprint as a higher frequency variation in EC on a broader long-term build-up of EC through vertical drainage, but would not halt the longer-term vertical drainage of overlying groundwater of higher EC. The latter process will act over a broader time scale and will operate while downward vertical head gradients are present. Even should pumping stop completely, vertical drainage will continue afterwards, while these (dissipating) vertical gradients exist.

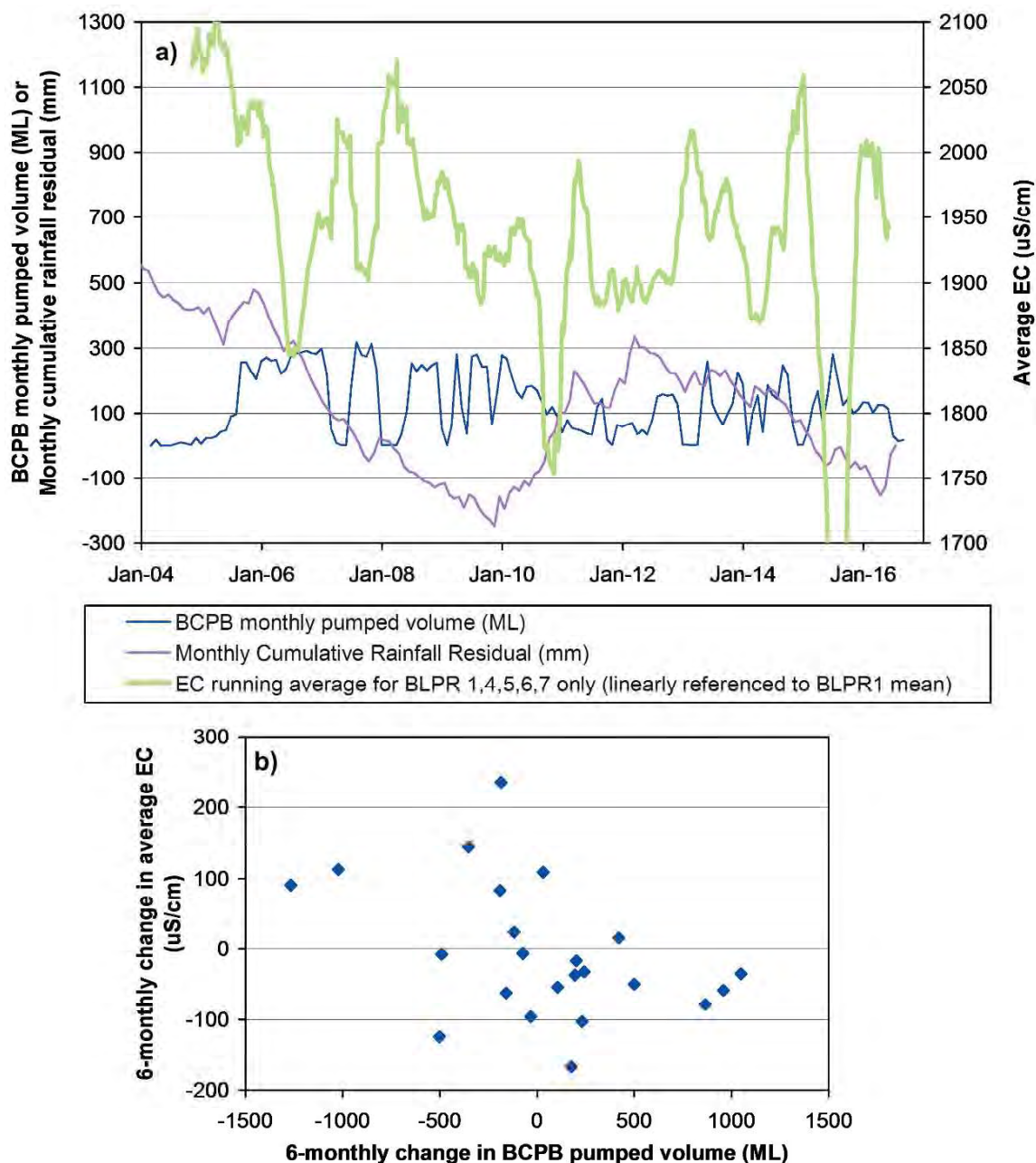

Figure 4-13: a) Comparison of average EC in the Lachlan Formation at the BCPB, and other trends; b) Correlation of EC and BCPB monthly derivatives

4.8. Groundwater Extraction

Groundwater extraction in the area covered by the model domain occurs from Evolution and private bores. Appendix E lists the pumping bores in the area, and contains a map showing their locations. The list excludes basic rights bores (registered for stock and domestic use) which have no associated entitlement. Basic rights bores are not active in the model. The following discussion excludes basic rights bores.

Table 1 in Appendix E lists the 18 active pumping bores in the model. The model simulates the groundwater system from 1998. Three bores (Billabong 1, 2, and 3) were decommissioned after 1998 and before 2016 and are not active during predictive simulations.

Large groundwater extraction rates are concentrated in three main areas. One of the areas encompasses the CGO, BCPB and ESB. The other two areas encompass private bores. These areas are identified on the map in Appendix E. Each area also has a monitoring piezometer used by the NSW government to monitor groundwater levels in the Lachlan Formation (at the request of the Bland Palaeochannel Groundwater Users Group) for groundwater management purposes. These piezometers have associated triggers defined by bore water levels where, should the bore water level fall to the trigger, various management actions are initiated.

If the investigation trigger level is breached, the effects on nearby users will be investigated and measures to mitigate impacts on water supply for existing stock and domestic use will be put in place for affected bores. If the mitigation trigger level is breached one or both of the following measures would be put in place in consultation with DIW:

- Alter the pumping regime to maintain the water level in the impacted stock and domestic bores;
- Maintain a water supply to the owner/s of impacted stock and domestic bores.

Table 2 lists the main pumping areas and associated pumping bores (see Appendix E for bore details) and trigger piezometers. The pumping bores listed in Table 2 account for about 96% of the known groundwater extraction from the Lachlan and Cowra Formations in the model area. All bores in Table 2 pump from the Lachlan Formation except the ESB which pumps from the Cowra Formation.

The operation of the BCPB and ESB is managed through the monitoring of water levels at GW036553. Water levels at GW036597 and GW036611 do not govern the operation of the BCPB and ESB.

Table 2: High-extraction pumping areas in the regional area

Area	Pumping Bores	DIW Trigger Piezometer	
		Registration No.	Trigger Level (m AHD)*
BCPB and ESB	BCPB: Evolution Bores 1 to 4. ESB: Evolution bores SB01 and SB02*	GW036553	137.5 (Investigation) 134.0 (Mitigation)
Billabong	Billabong 4 and Billabong 6	GW036597	143.7
Maslin	Maslin Bore	GW036611	145.8

* ESB pumping bores SB03 to SB05 (see Appendix E) are currently not used for pumping.

4.9. BCPB and ESB usage

Total usage for each of the BCPB and ESB, from commencement of the CGO (1 July 2004) to 31 December 2019, is shown graphically in Figure 4-7 and Figure 4-8. The regulatory constraints for BCPB pumping (from the four bores in total), under the licence conditions, are understood to be as follows:

- Daily maximum of 15 ML.
- Yearly maximum of 3,650 ML.

In addition, the operation of the BCPB and ESB is managed through the monitoring of water levels at GW036553. Should the bore water level at GW036553 fall to the trigger level at that bore, various management actions are initiated. Water levels at GW036597 and GW036611 do not govern the operation of the BCPB and ESB.

The water supply for the CGO includes a number of surface water and groundwater supplies. Surface water supplies, which are dependent on rainfall, comprise runoff from a series of dams and associated catchments within the Mining Lease, and use of water supplied via the Jemalong irrigation channel when available.

4.10. Groundwater Extraction to Date

Groundwater extraction at the bores in Table 2, over the period 1 July 2004 to 31 December 2019, resulted in groundwater levels above the trigger levels at the three DIW trigger piezometers. The lowest observed groundwater levels over the period 1 July 2004 to 31 December 2019 were as follows:

- BCPB Area bore GW036553: 7.5 m above trigger (141.5 m AHD on 15 January 2010);
- Billabong Area bore GW036597: 1.5 m above trigger (145.2 m AHD on 21-23 November 2019);
- Maslin Area bore GW036611: 1.6 m above trigger (147.4 m AHD on 16 December 2019).

These extraction rates (including extraction undertaken at Billabong 1, 2, and 3, and excluding pumping at the ESB) are listed in Table 3. The pumping rate for the BCPB was obtained from records. Estimates based on historical information and advice were made for the extraction for irrigation at the Billabong and Maslin properties.

Table 3: Pumping rates at the high extraction bores, averaged over the period 1 July 2004 to 31 December 2019

Area	Pumping Bores	Average Pumping Rate over the period 1 July 2004 to 31 December 2019 (ML/day)
BCPB	Evolution Bores 1 to 4.	4.1
Billabong *	Billabong 1, 2, 3, 4 and 6	2.8
Maslin *	Maslin Bore	2.7

* Significant assumptions have been made in estimating pumping for these bores.

5. Hydrogeological Conceptual Model

Monitoring data collected at the CGO since 2013, supplied to Coffey, supports the conceptual model used in Coffey (2013). There are no observations that suggest any alteration to the conceptual model. The conceptual model from 2013 is adopted in the current study and summarised below.

The climate in the model area is characterised by low rainfall and high evaporation. For average conditions, a rainfall deficit occurs over most months of the year. Surface drainage is intermittent.

Recharge to the groundwater system occurs by the following processes:

- Rainfall infiltration.
- Leakage from Bland Creek when flowing.
- Intermittent flooding.
- Deep drainage from irrigation practices (mostly in the northern areas).
- Groundwater inflow through the Corinella Constriction.

There will also be a minor component of recharge to the fringes of the alluvial sequence from shallow bedrock which will have higher conductivity due to lower overburden pressures.

The subsurface medium comprises unconsolidated sediments. Finer-grained, lower hydraulic conductivity sediments overlie a thin but significant sequence of coarser-grained, higher hydraulic conductivity sediments. Media properties, combined with the prevailing climate, creates a system of high groundwater salinity near the surface and lower salinity at depth. Observations collected at the ESB since 2012 have allowed a more detailed definition of the variation of EC with depth.

Discharge from the groundwater system occurs by the following processes:

- Extraction from water supply bores for stock/domestic, irrigation, and industrial uses.
- Intermittent evaporation from surface ponds (local groundwater flow systems only).
- Groundwater outflow through the Corinella Constriction.

Figure 5-1 shows a graphical representation of the hydrogeological conceptual model.

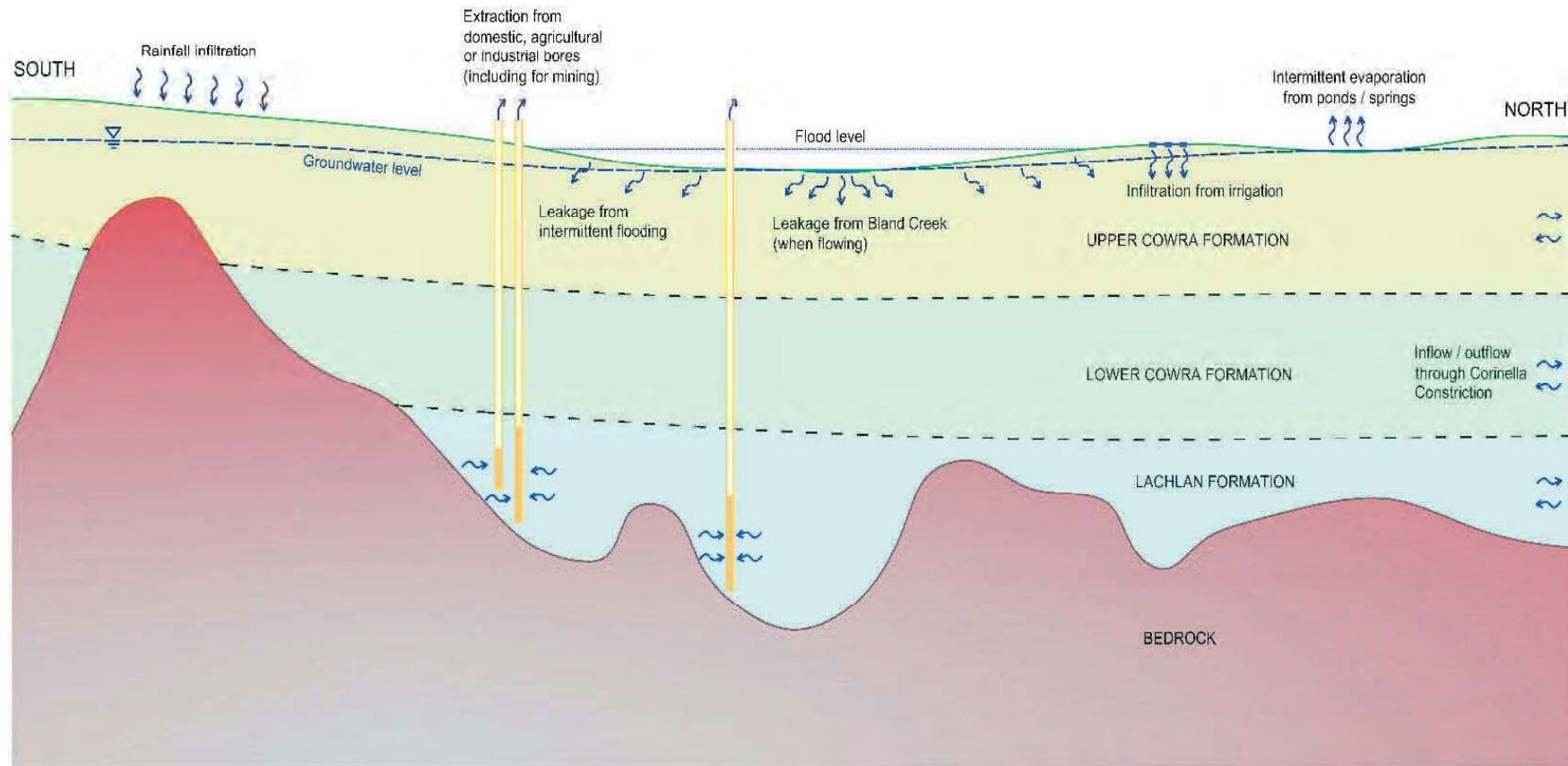

Figure 5-1: Hydrogeological conceptual model

6. Numerical Model Development and Verification

6.1. Model Structure

Numerical modelling was carried out using the 2000 version of the groundwater simulation algorithm MODFLOW, compiled by the United States Geological Survey (Harbaugh et al, 2000). MODFLOW is a three-dimensional, finite difference, block-centred flow algorithm. It is an internationally recognised groundwater simulation algorithm accepted by most water resource authorities in Australia and world-wide.

The model active area covers about 1,800 km². The model mesh consists of a uniform grid of 50 m by 50 m cells over the BCPB area (covering an area of about 36 km²) gradually expanding to a maximum cell size of 1 km by 1 km at the edges of the model area. Cell dimensions increase by a factor of 1.2 between cells to maintain numerical stability and allow accurate calculation of heads. The model domain is shown in Figure 6-1 and the model mesh is shown in Figure 6-2.

The model is discretised in the time domain using a model time step size of 3 days between January 2011 and January 2046 and a model time step size of 9 days between January 1998 and December 2011 and between February 2046 and June 2050.

The groundwater system is represented in the model using three layers as follows:

- Layer 1: The Upper Cowra Formation (unconfined). The base of the Upper Cowra is set to 47 m below ground level based on hydraulic conductivity data and downhole gamma logs from bores in the vicinity of the BCPB (see Coffey, 2013).
- Layer 2: The Lower Cowra Formation (confined / unconfined).
- Layer 3: The Lachlan Formation (confined / unconfined).

The Upper Cowra Formation has one parameter zone. The Lower Cowra Formation has three parameter zones (northern, central, and southern) of approximately equal extent, broadly based on geology. The Lachlan Formation has two parameter zones representing:

- High hydraulic conductivity sands and gravels close to and within the deeper parts of the palaeochannel.
- Lower hydraulic conductivity, finer-grained sediments that generally occur further away from the deeper parts of the palaeochannel and surround the high hydraulic conductivity sands and gravels.

Bedrock in the Bland Creek Palaeochannel underlying the alluvial sequence has been assumed to be impermeable for the purpose of numerical simulation. This is considered reasonable since the high hydraulic conductivity parts of the Lachlan Formation have a hydraulic conductivity approximately 100 to 1000 times larger than underlying bedrock, as discussed in Section 4.5.1.

The model layer extents, parameter zones and boundary condition locations are shown in Figure 6-3.

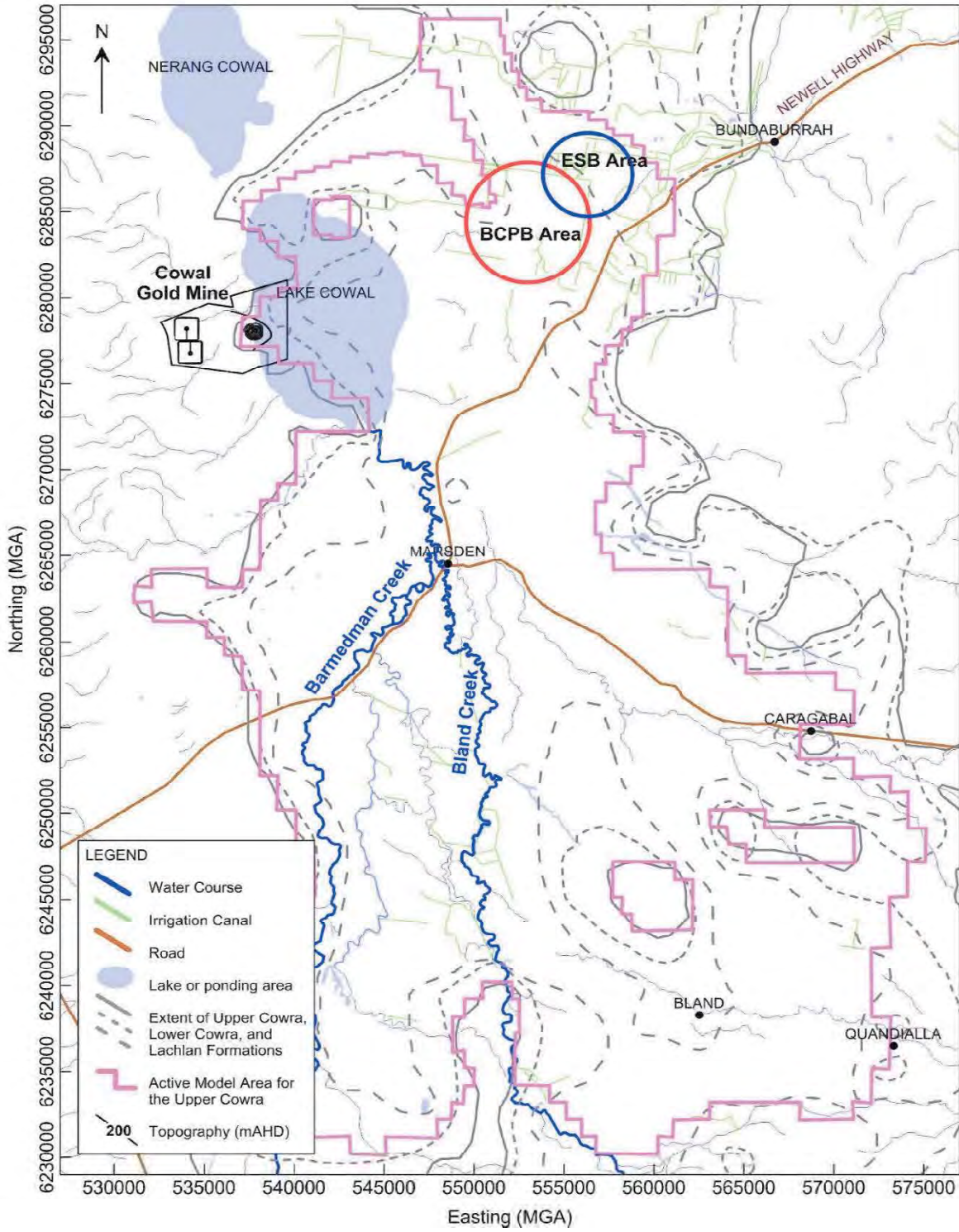

Figure 6-1: Model domain

Cowal Gold Operations Underground EIS
BCPB and ESB Groundwater Assessment

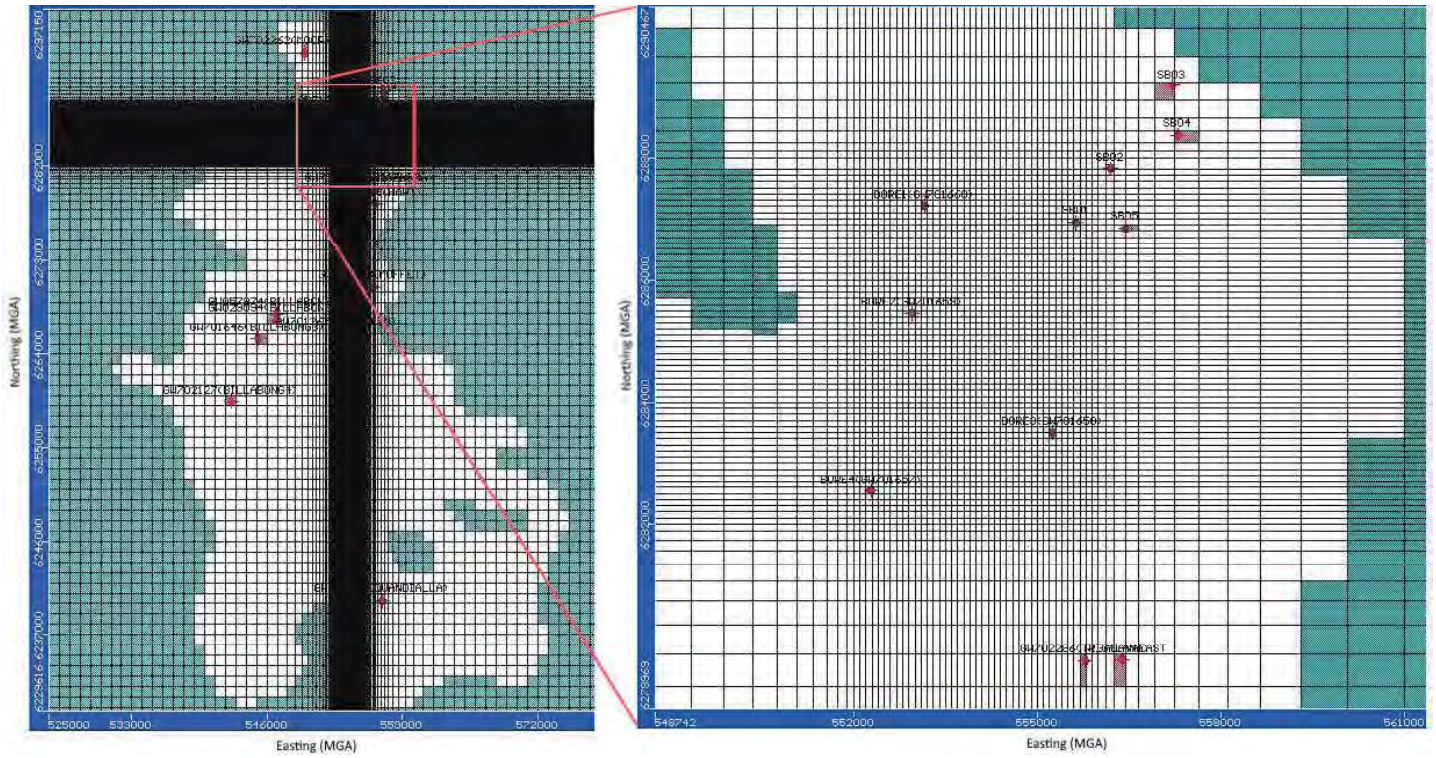

Figure 6-2: Model mesh

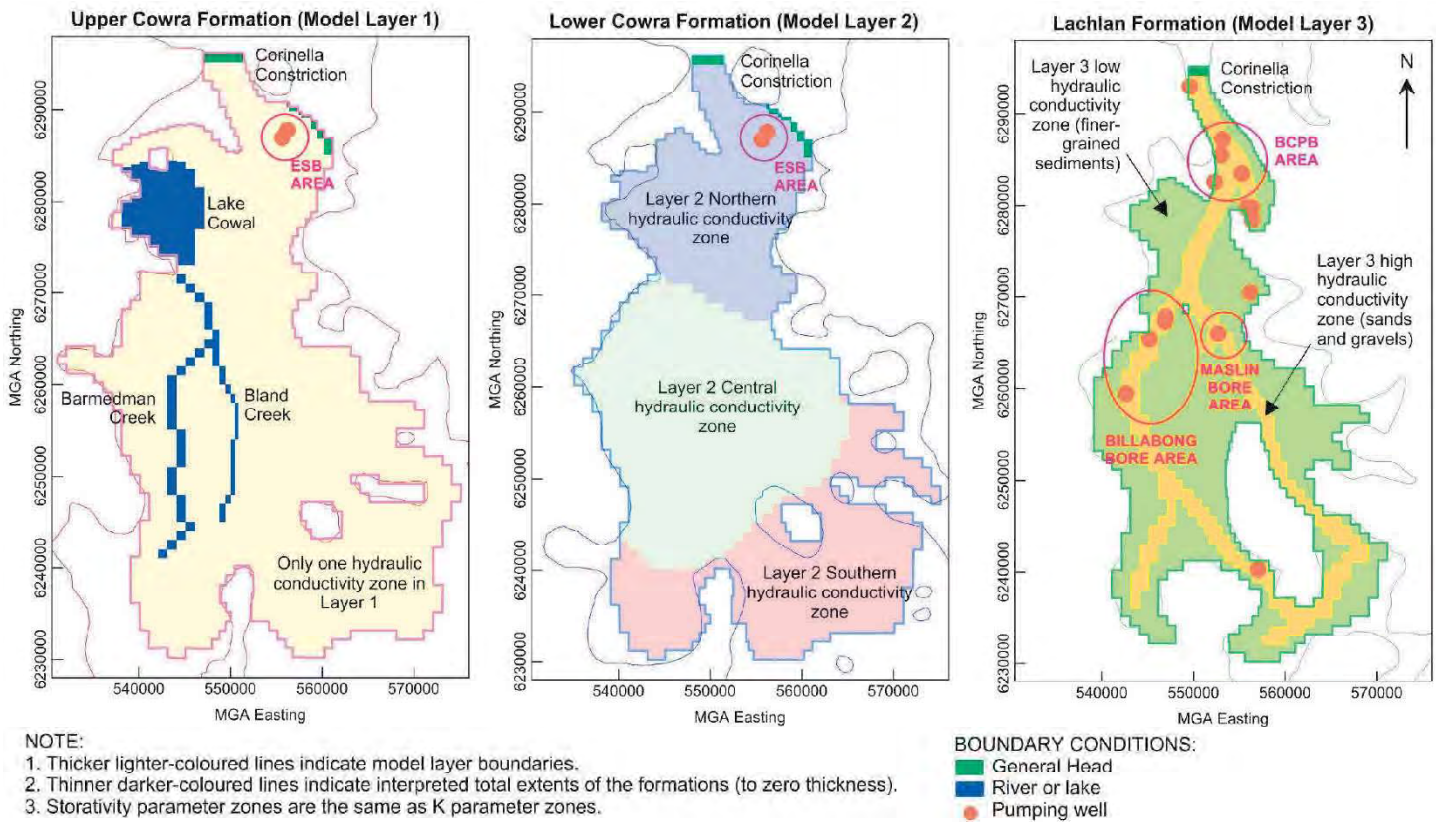

Figure 6-3: Model layers and boundary condition locations

The calibrated aquifer parameters and boundary conditions are provided in Table 4.

The southern boundary was modelled as a no flow boundary. This was considered appropriate for the purposes of the model. The southern boundary is located some 50 km south of the BCPB and 30 km south of the Billabong and Maslin areas. The influence of the southern model boundary condition on model results at the BCPB area is limited due to its distance from the borefield and the presence of lower hydraulic conductivity material in the Lachlan Formation away from the palaeochannel. Potential flow from the southern model boundary to the BCPB is likely to be an order of magnitude smaller than that from the Corinella Constriction, which is located at the northern model boundary, less than 10 km from the BCPB area, and is connected to the BCPB area via the higher hydraulic conductivity parts of the Lachlan Formation, as shown in Figure 6-3.

Appendix F provides further details of the model boundary conditions and aquifer parameters.

Table 4: Calibrated model media parameters

Parameter	Upper Cowra	Lower Cowra (North)	Lower Cowra (Central)	Lower Cowra (South)	Lachlan (Low conductivity)	Lachlan (High conductivity)
Horizontal hydraulic conductivity (m/day)	1	2	1	1	3	28
Average thickness over model area (m)	35	34	34	34	30	30
Average transmissivity over model area (m ² /day)	35	68	34	34	90	840
Vertical hydraulic conductivity (m/day)	6 x 10 ⁻⁵	1 x 10 ⁻⁵	6 x 10 ⁻⁶	1 x 10 ⁻⁵	3	28
Specific storage (m ⁻¹)	N/A	1.5 x 10 ⁻⁵	1.5 x 10 ⁻⁵	1.5 x 10 ⁻⁵	1.5 x 10 ⁻⁵	1.5 x 10 ⁻⁵
Specific yield	0.04	N/A	N/A	N/A	N/A	N/A
General head boundaries						
External head (m AHD)	198	196	N/A	N/A	N/A	196
Conductance (m ² /day)	1	1	N/A	N/A	N/A	25
Riverbed conductance (m²/day)						
Bland and Barmedman Creeks	10	N/A	N/A	N/A	N/A	N/A
Lake Cowal	5	N/A	N/A	N/A	N/A	N/A
Rainfall Recharge (% of average annual rainfall)	1.0	N/A	N/A	N/A	N/A	N/A

6.2. Numerical Model Verification

Coffey 2013 provides a detailed description of the numerical model and the recalibration undertaken in 2010. Numerical modelling has been conducted in accordance with the Australian Groundwater Modelling Guidelines (Barnett et al., 2012).

In the current work, model verification of measured water levels was undertaken for the following piezometers:

- Evolution BLPR piezometer series (monitoring of the BCPB).
- Evolution PZ02. The screen for this piezometer straddles the model boundary between Layers 1 and 2 (the Upper and Lower Cowra Formations respectively). Verification is undertaken by extracting modelled water levels in both Layers 1 and 2 and comparing to observations.
- DIW trigger piezometers (GW036553, GW036597 and GW036611).

Apart from the bores in the BCPB, the bores with the three largest groundwater extraction rates in the model area are Billabong 4, Billabong 6, and Maslin. This extraction significantly affects water levels in DIW trigger piezometers GW036597 and GW036611. Prior to the 2017 work (Coffey, 2018), available usage data for these private pumping bores covered a period up to 1 July 2010 only. As part of the 2017 modelling, usage for the Billabong bores was supplied by the proponent for the period January 2014 to August 2017 inclusive. Usages for the Billabong bores from 2010 to 2014 and 2017 to 2019 have been estimated. Usage for the Maslin bore between 2010 and 2019 has been estimated assuming a pump capacity of 12 ML/day. Usage estimates are discussed further in Section 7.2.

6.3. Results

Verification hydrographs for the DIW mitigation trigger piezometers are shown in Figure 6-4. Verification hydrographs for the BLPR series, and PZ02, are shown in Appendix G.

The modelled hydrograph for GW036553 indicates over-prediction of water levels from about 2012. Modelled hydrographs for GW036597 and GW036611 are reasonable, however modelled recovery is slower than observed. To incorporate the over-prediction present in modelled hydrographs in predictive simulations, the disparity between modelled and observed water levels is taken for the two lowest water level troughs in the series between 2014 and the present, and the averages of these taken. This results in the following over-prediction of observed hydrographs, as listed in Table 5. Modelled and observed patterns show reasonable agreement.

Table 5: Model over-prediction of DIW trigger piezometer hydrographs

Piezometer	Date	Water Level (m AHD)		Difference (m)	Average Difference (m)	Effective Trigger Level (m AHD)
		Observed	Calculated			
GW036553 (BCPB Area)	15-Jul-15	144.6	150.7	+ 6.1	+ 6.0	134.0 + 6.0 = 140.0
	29-Nov-17	145.5	151.5	+ 6.0		
GW036597 (Billabong Area)	22-Mar-19	146.1	148.2	+ 2.1	+ 2.7	143.7 + 2.7 = 146.4
	23-Nov-19	145.2	148.5	+ 3.4		
GW036611 (Maslin Area)	5-Nov-19	151.9	154.6	+ 2.7	+ 3.5	145.8 + 3.5 = 149.3
	16-Dec-19	147.4	151.7	+ 4.3		

Note: Component values are rounded to one decimal place. Totals are calculated from unrounded component values, then rounded to 1 decimal place, therefore each total may differ slightly from the sum of corresponding rounded components.

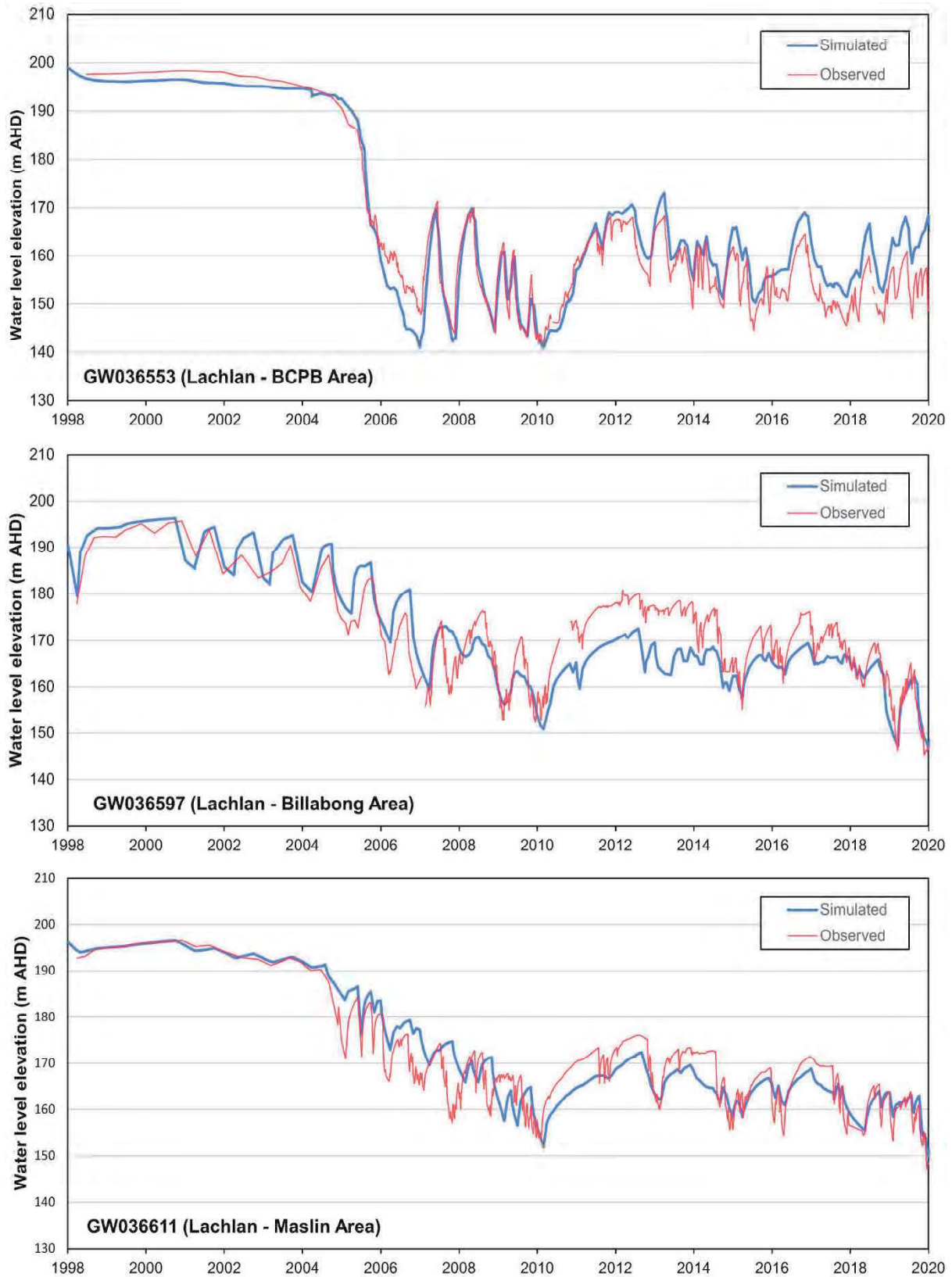

Figure 6-4: Verification hydrographs for DIW trigger piezometers

A comparison of the modelled versus observed results at the three DIW trigger piezometers and the seven BLPR series piezometers, as shown in Appendix G, results in a normalised root mean square error (NRMSE) of 9.2 % for the model calibration. This indicates a reasonable match between observations and model results.

Modelled versus observed groundwater levels are shown in Figure 6-5.

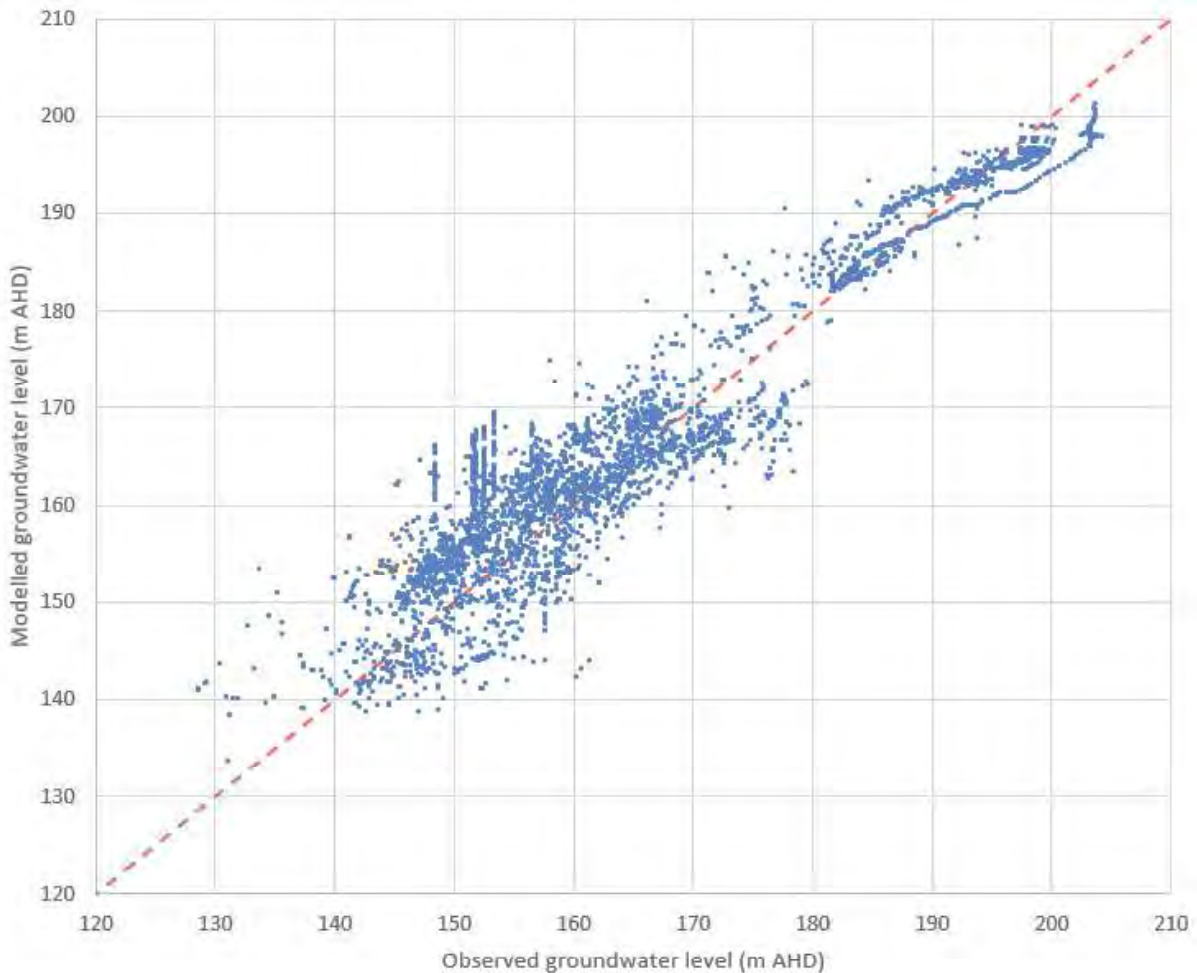

Figure 6-5: Modelled versus observed groundwater levels

The relative sensitivity of the NRMSE of the calibration to the hydraulic conductivity parameters, was assessed by varying each of these parameters by +50% and -50% and assessing the maximum percentage increase in the NRMSE for each parameter. The results are shown in Figure 6-6, normalised to provide relative sensitivities. It can be seen from Figure 6-6 that model calibration is most sensitive to the vertical hydraulic conductivity in the Lower Cowra Formation and the isotropic hydraulic conductivity in the Lachlan Formation.

The mass balance error in the numerical model is below 1% at all time steps. Figure 6-7 shows the mass balance error at selected times.

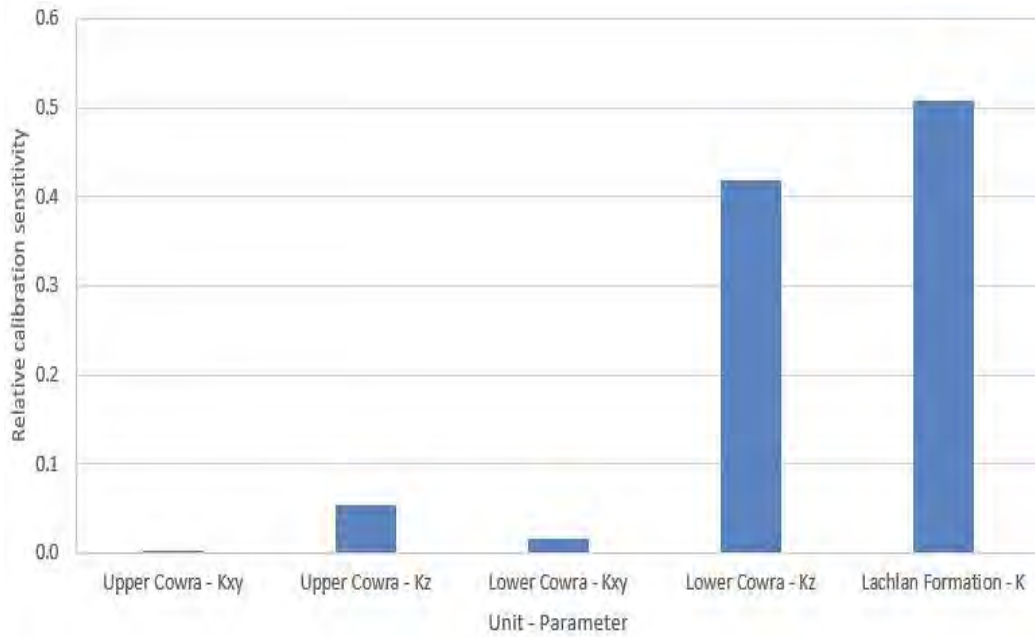

Figure 6-6: Calibration sensitivity to hydraulic conductivity parameters

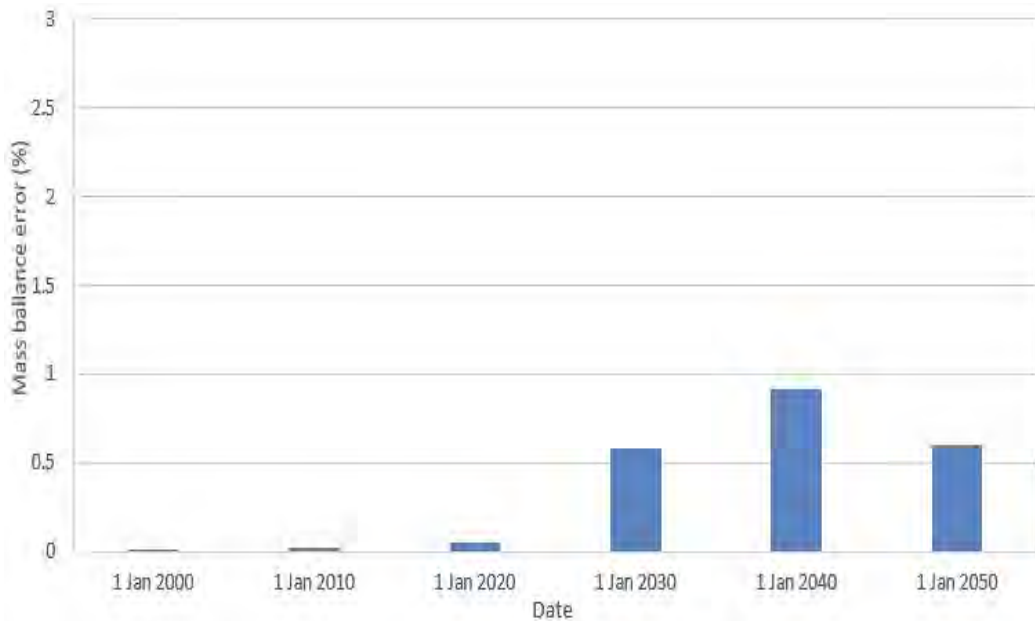

Figure 6-7: Mass balance error (%) at selected times

6.4. Model Classification

The Australian Groundwater Modelling Guidelines (Barnett et al, 2012) provide discussion on confidence level classifications for numerical groundwater models. The model described in this report is considered to meet the criteria for Class 2, with some aspects of Class 3. A summary of the key indicators is provided below:

- The model is based on groundwater level monitoring data and extraction records for piezometers and extraction bores in and around the model domain, in particular at the BCPB borefield.
- A conceptual model has been developed, incorporating the principal hydrogeological units and the main sources of groundwater recharge and discharge in the area covered by the model.
- Calibration has been carried out against three DIW trigger piezometers and seven observation piezometers (BLPR series piezometers) for a calibration/verification period of 21 years (1998 to 2019).
- The calibration statistics provide a NRMSE of 9.2% which indicates a reasonable match between observations and model results.
- The model is used to predict impacts to groundwater levels due to extraction from the BCPB borefield until 2040 and 10 years of recovery. The predictive timeframe of 30 years (2020 to 2050) is comparable to the timeframe used for calibration.
- The groundwater stresses for the predictive modelling period are similar to those for the calibration period. These principal stresses are groundwater extraction from the BCPB, ESB and private bores.
- The time discretisation for the predictive modelling period is the same as that for the calibration period, refer to Section 6.1.
- The mass balance error in the numerical model is below 1 % at all time steps.

7. Predictive Simulation

7.1. Simulations

Predictive simulations were modelled as follows:

- Case 1, the BCPB pumps at the maximum possible rate, beginning 1 January 2020, such that the water level in DIW trigger piezometer does not fall below the mitigation trigger level of 134 m AHD. ESB pumping is fixed at 1.5 ML/day (requested by Evolution in the same scenario undertaken in 2013 and adopted here). BCPB and ESB pumping terminates on 30 June 2040.
- A null case, where CGO pumping never occurs.

For the pumping case, the total pumping is distributed amongst the four bores of the BCPB and the two bores of the ESB according to the proportions pumped by each bore up to 31 December 2019. Pumping at the ESB is subject to the drawdown constraint where the groundwater level in PZ02 (the ESB monitoring piezometer historically showing the largest drawdown) is not to fall below the base of the bore screens. Based on supplied information, the elevation of the base of the PZ02 bore screen is 144.6 m AHD.

The simulations cover a future period of 30 years commencing on 1 January 2020 and ending on 30 June 2050. This allows for 10 years of recovery following termination of pumping at the BCPB and ESB. The following future conditions are applied:

- Average rainfall occurs from 1 January 2020 as an invariant annual rate equivalent to 1% of 475 mm/year (the average rainfall at Wyalong Post Office between 1895 and 2019).
- Water levels for Lake Cowal, and Bland and Barmedman Creeks, have been assigned by calculating their average water levels over the period of record and applying these averages over the entire simulation period. These averages are 0.35 m for Bland and Barmedman Creeks and 0.5 m for Lake Cowal.
- Private pumping as defined in the following section.

7.2. Private Bore Pumping

Nine private bores are active during the predictive simulations, as listed in Table 6. These bores all pump from the Lachlan Formation. Actual past usage is available for four of the bores up to June 2010. Usage is also available for the Billabong bores between 2014 and 2017.

For the purpose of verification of the hydrograph for GW036597, usage for the two Billabong bores was estimated from 2010 to 2013 and 2017 to 2019 using a pump capacity of 5 ML/day, and on/off times interpreted from the GW036597 hydrograph. To match the observed GW036597 hydrograph troughs in March and November 2019, both Billabong bores were estimated to be pumping at 5 ML/day, a total rate of 10 ML/day. Previous modelling assumed a pump capacity of 4 ML/day.

For the purpose of verification of the hydrograph for GW036611, usage for Maslin was estimated using a pump capacity of 12 ML/day, and on/off times interpreted from the GW036611 hydrograph. To match the observed GW036611 hydrograph troughs in November and December 2019, the Maslin bore was estimated to be pumping at 12 ML/day. Previous modelling assumed a pump capacity of 7 ML/day.

No usage information has ever been received for five of the bores. In 2007 the Lachlan Valley Water Group (LVWG) supplied future usage estimates for all nine bores, listed in Table 6, for use in predictive simulations.

The combined LVWG estimate for the Billabong bores is 4.62 ML/day, which compares with an estimated average actual pumping (from significant assumptions) of 2.8 ML/day used in the verification modelling (see Table 3). The LVWG estimate for the Maslin bore is 4.52 ML/day, which compares with an estimated average actual pumping (from significant assumptions) of 2.7 ML/day used in the verification modelling (see Table 3). The LVWG estimates were used in the current work for predictive simulations (applied from 1 January 2020).

Table 6: Private bore future average annual pumping rates for modelling

Bore	Estimated future average annual usage as at 2007 (Lachlan Valley Water Group)^ (ML/day)
Billabong 3/6*	2.22
Billabong 4	2.40
Maslin	4.52
Quandialla TWS	0.10
Hart	0.02
Moora Moora	0.13
Muffet	0.02
Trigalana	0.08
Trigalana East	0.13
Total:	9.62

* Billabong 3 was replaced by Billabong 6 in 2008 (see Appendix E).

^ Used for predictive simulations (applied from 1 January 2020).

7.2.1. Inactive Pumping Bores

Table 2 in Appendix E lists an additional 10 licensed private pumping bores in the model area that have the potential to pump large amounts, but for which no usage data have ever been received, and no usage estimates have ever been supplied. Their status is unknown, and as a result, they are designated inactive in the model. It is not known if any of these may be pumping groundwater, however their inactivity has allowed reasonable replication of water level observations up to the present. Their future usage was unable to be estimated and they are inactive in predictive simulations.

The Warrakimbo bore, located very close to the Maslin bore, is licensed for irrigation and has a large allocation. To match the observed GW036611 hydrograph troughs in November and December 2019, the Maslin bore was estimated to be pumping at 12 ML/day. Previous modelling assumed a pump capacity of 7 ML/day. The Warrakimbo bore may have been in use during these periods of low water levels and it is recommended that potential water usage from this bore is obtained.

Billabong 5 was completed on 23 December 2008 as a replacement for Billabong 1 and 2. The potential for this bore to have been used since 2008, or to be used in the future, is high. To match the observed GW036597 hydrograph troughs in March and November 2019, Billabong bores 4 and 6 were estimated to be pumping at 5 ML/day, a total rate of 10 ML/day. Previous modelling assumed a pump capacity of 4 ML/day. The Billabong 5 bore may have been in use during these periods of low water levels and it is recommended that potential water usage from this bore is obtained.

As at 2010, it was understood that the bore installed by Mr Mattiske in 2007 (not active in the model) approximately midway between Bores 1 and 2 of the BCPB, did not operate. Its operation after 2010 is unknown.

7.3. Results

7.3.1. Water Level Hydrographs

Table 5 shows that the numerical model under predicted drawdown at monitoring bore GW036553 by approximately 6.0 m during periods of high groundwater extraction in 2015 and 2017. While the form of modelled response follows observations a discrepancy between measurement and modelled groundwater level has gradually developed.

The separation between model result and measurement was taken into account by incorporation of an offset on the trigger level to compensate for the departure in the modelling result from observation.

The modelled pumping rate was as follows:

- Case 1 - Model over prediction incorporated (6.0 m added to the mitigation trigger value (134 m AHD) to account for model over prediction): 4.0 ML/day.

Figure 7-1 shows the predicted hydrographs for DIW trigger piezometers for Case 1, and for the null case. For the predictions in the irrigation area approximately 15 km to the south of the mine bores, the effects of groundwater extraction for CGO were assessed by adding the predicted drawdown associated with mining to the measure of historic low groundwater levels at each of two monitoring bores for which trigger levels are established. The representation of historic low groundwater levels was taken as the average of the five lowest level events on record. The low levels and the timing of these events are shown in Figure 7-1. In each case they are interpreted to correspond to the end of a period of pumping for irrigation. This approach is adopted to address the uncertainty in recent and future pumping rates from the irrigation bores. Results are discussed below.

Modelled future pumping rates are reported to the nearest 0.1 ML/day, rounded down. At a continual pumping rate of 4.0 ML/day, the model indicates that the water level at GW036553 does not fall below the effective mitigation trigger value of 140.0 m AHD (134 m AHD actual, plus 6.0 m to account for model over prediction of groundwater level).

Water levels at GW036597 and GW036611 would not fall below the respective effective trigger values based on predicted mining impacts upon the low historic levels at these locations. At both GW036597 and GW036611 there is minimal freeboard available at the end of pumping in June 2040 (about 2 m and 1 m respectively, taking into account the model over prediction listed in Table 5), to accommodate BCPB pumping.

Operation of the BCPB and ESB is governed by water levels at trigger piezometer GW036553. Water levels at trigger piezometers GW036597 and GW036611 do not govern the operation of the BCPB and ESB and are included in Figure 7-1 for information purposes only.

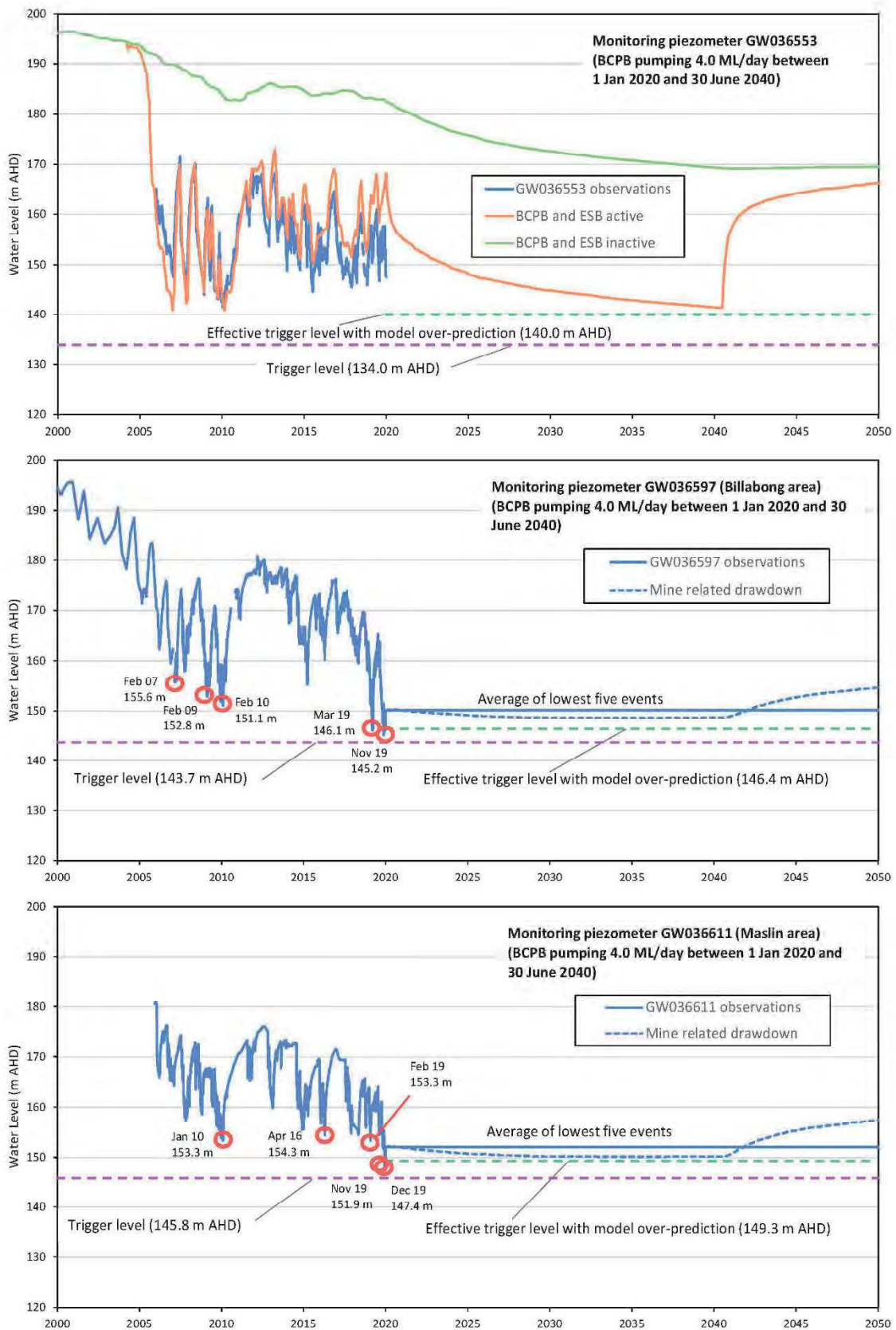

Figure 7-1: Predictive hydrographs for DIW trigger piezometers for Case 1 (mine impact)

7.3.2. Water Level Drawdown

Results are presented for Case 1.

Groundwater drawdown (compared with 1998 groundwater levels) achieves a maximum just before the end of BCPB and ESB operation, on 30 June 2040. At this time, the maximum modelled drawdown in the Upper Cowra Formation is 2.7 m, occurring in the central part of the ESB. This drawdown is not expected to create difficulty for the majority of private bores in the area.

Drawdown in the Lower Cowra and Lachlan Formations for 30 June 2040 are shown in Appendix H. Table 7 provides a summary of results.

Table 7: Drawdown in the Lower Cowra and Lachlan Formations for 30 June 2040 (cessation of BCPB and ESB pumping)

Formation and Location	Case 1
Maximum drawdown in Lower Cowra Formation	
Drawdown (m)	40.4
Location	ESB
Maximum drawdown in Lachlan Formation	
Drawdown (m)	68.2
Location	Maslin Area
Maximum drawdown in Lachlan Formation over the BCPB (m)	60.6

There are private registered bores screened in the Lachlan Formation in the area of the BCPB, however impacts on these bores are being monitored and mitigation measures have been developed to mitigate potential impacts (see below).

Based on a search of registered private water bore records in 2011, there are 34 private bores (excluding government piezometers and Evolution piezometers or pumping bores) within 15 km of the BCPB and ESB which appear to be screened in the Upper and/or Lower Cowra Formations (depths less than 90 m). 32 of these bores are located outside the model domain (29 are located to the east and north east, on the other side of rock ridges or interpreted shallow bedrock, and three are located to the north northeast, past the northern model boundary and within the northernmost parts of the Corinella Constriction). The remaining two bores are GW029574 and GW702230 (known as the Duff Bore). Their locations are shown on the map in Appendix E. Table 8 lists known completion details for these bores.

Table 8: Registered private bores screened in the Cowra formation within 15 km of the BCPB and ESB (excluding government and Evolution bores)

Bore	Easting (m MGA)	Northing (m MGA)	Depth (m bgl)	Water level (m bgl)	Licensed use
GW029574	553360	6273194	88	30	Stock
GW702230 (Duff Bore)	555812	6287547	66		Irrigation

GW702230 (Duff Bore) is located within the ESB. There is understood to be an agreement between Evolution and the bore owner that permits temporary transfer of water from this bore for use in the CGO water supply.

Government bore records indicate that GW029574 is privately owned and was installed in 1969. A maximum modelled drawdown of about 31.9 m (in the Lower Cowra Formation) is calculated for GW029574, however the bore is 88 m deep and may be able to continue operation if the screen length is sufficiently long and optimally located.

7.3.3. Flow Budgets

Table 9 lists the modelled groundwater flow budget for 30 June 2040, immediately prior to cessation of pumping at the BCPB and ESB, for Case 1, and the null case (BCPB and ESB inactive for the entire simulation period). This time is the time of greatest groundwater drawdown.

Table 9: Flow budgets at the end of BCPB and ESB pumping (30 June 2040)

Component	Case 1		Null (BCPB and ESB Inactive)	
	In (ML/day)	Out (ML/day)	In (ML/day)	Out (ML/day)
Recharge	17.74		17.74	
Media storage	2.08	8.22	1.90	10.30
River leakage	0.02	1.15	0.02	1.38
Flow across Corinella Constriction	4.82	0.25	1.95	0.31
Pumping		15.12		9.62
Total	24.66	24.75	21.61	21.61
Discrepancy	-0.09		0.01	

Note: Component values are rounded to two decimal places. Totals are calculated from unrounded component values, then rounded to 2 decimal places, therefore each total may differ slightly from the sum of corresponding rounded components.

Flow budgets indicate that groundwater pumping is being sourced almost entirely from media storage on 30 June 2040. Flow budget discrepancies are reasonable.

As noted in Section 6.3, the discrepancy (mass balance error) is less than 1% of the total flow at all model time steps.

7.3.4. Salinity

When a fresh water source is pumped and draws vertical leakage from an overlying source of higher salinity, the resulting distribution of total dissolved solids (TDS) concentration in the pumped source is not uniform. The concentration distribution will first be controlled significantly by the variation in the vertical hydraulic head difference between the sources (which is a maximum at the pumped bore). This distribution may change with time, during and after pumping, depending on the magnitude of lateral flow and other factors.

Based on numerical simulation of salinity concentrations undertaken in Coffey (2016) for Cowal Gold Operations Mine Life Modification (MOD13), it was estimated that total dissolved solids concentrations at BLPR1 will increase by 20% or less, by 31 December 2032, from pre-mining concentrations.

Figure 7-2 shows modelled and observed TDS concentrations at BLPR1 (using a conversion factor of 0.67 mg/L per $\mu\text{S}/\text{cm}$). Observed and calculated TDS concentrations show reasonable agreement excluding localised fluctuations at the pumping bore. Modelling of pumping ceasing at 31 December 2032 indicates TDS at BLPR1 will increase to around 1760 mg/L by 30 June 2040, an increase of about 40% from pre-mining concentrations.

EC trends are relatively stable after 15 years of mine water supply pumping, as illustrated in Figure 4-12 and reported in the latest annual groundwater review (Coffey, 2020). An increase in TDS of 40% or less by 30 June 2040 is therefore considered a reasonable estimate.

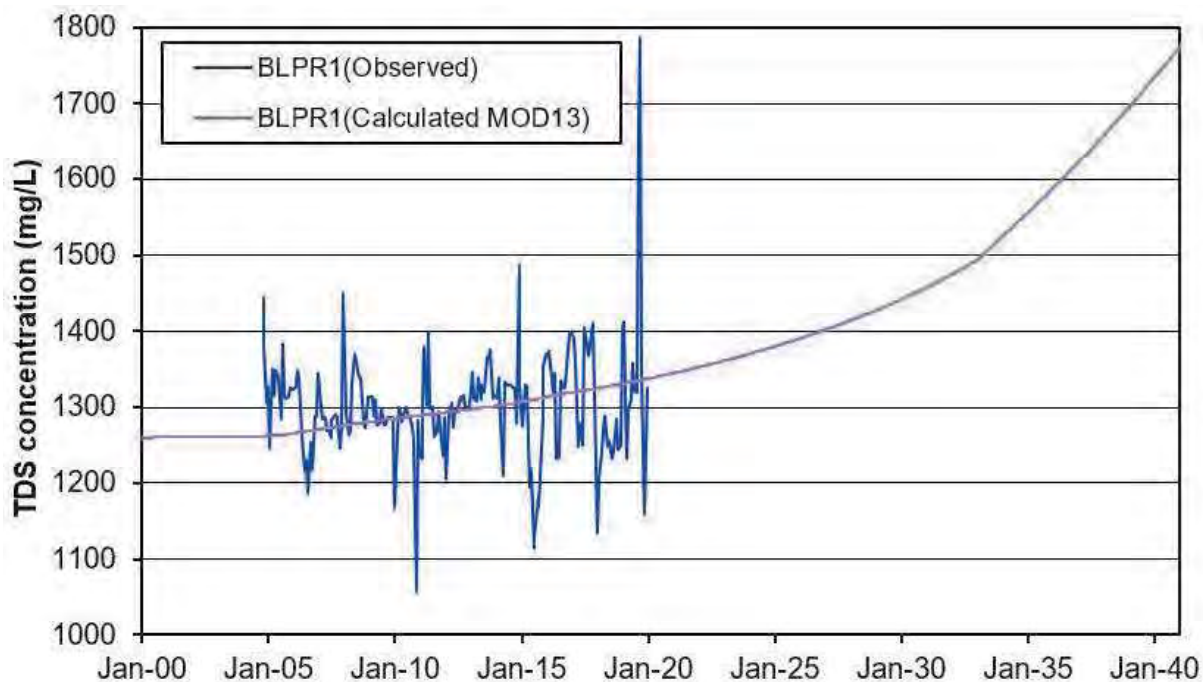

Figure 7-2: Modelled and observed TDS concentrations in the BCPB

7.3.5. Post-mining Water Levels

When ESB and BCPB pumping stops, groundwater levels at GW036553 are predicted to recover to around 166 m AHD in 10 years (about 30 m below 1998 water levels), and would continue to gradually recover over time, to a level that is dependent on the amount historically pumped, private bore usage following CGO closure, and climate. It may take significant periods of time for water levels to recover to levels seen in the late 1990s (prior to the drought and onset of extensive pumping) because of the low rate of media recharge and continuing pumping for agricultural purposes.

8. Predictive Uncertainty Assessment

A deterministic scenario analysis was carried out to assess model parameter and observational uncertainty.

As discussed in Section 6.3, in terms of hydraulic conductivity parameters, the model is most sensitive to the vertical hydraulic conductivity in the Lower Cowra Formation and the isotropic hydraulic conductivity in the Lachlan Formation. An assessment of parameter uncertainty was carried out by varying these parameters and assessing model predicted groundwater levels at GW036553 from 2020 to the end of mine life in 2040.

With reference to the hydraulic conductivity test results in Section 4.5.1 and considering variations in the hydraulic conductivity parameters such that the NRMSE between observed and modelled results remains less than 15%, the following four model runs were carried out to assess model parameter uncertainty:

- Upper Cowra Formation vertical hydraulic conductivity x 1.5.
- Upper Cowra Formation vertical hydraulic conductivity x 0.5.

- Lachlan Formation hydraulic conductivity x 1.5.
- Lachlan Formation hydraulic conductivity x 0.75.

The predicted drawdown at GW036553 is affected by the predicted pumping rate at private bores Billabong 3/6, Billabong 4 and Maslin. The pumping rate at these bores is generally higher in dry periods and generally lower during periods with above average rainfall. To provide an assessment of this observational uncertainty, the following two model runs were carried out, using the adopted model hydraulic conductivity parameters:

- Billabong 3/6, Billabong 4 and Maslin bore pumping rates (see Table 6) x 1.5.
- Billabong 3/6, Billabong 4 and Maslin bore pumping rates x 0.5.

Figure 8-1 shows the predicted groundwater levels at GW036553 from 2020 to 2040 for the four model parameter uncertainty cases and the two private bore pumping rate observational uncertainty cases.

Considering the worst case scenario for model parameter uncertainty, the water level at trigger piezometer GW036553 would be predicted to reach the effective trigger level (refer to Table 5) in late 2033. On the other hand, considering the best case scenario for model parameter uncertainty, the water level at GW036553 is predicted to be approximately 4 m higher than the effective trigger level in 2040.

The effects of the uncertainty in the rate of irrigator pumping from Billabong 3/6, Billabong 4 and Maslin are clearly evident. A 50% increase in the future pumping rate from these bores results in the predicted water level at GW036553 reaching the effective trigger level in 2026. This also shows the importance of climate on future groundwater availability. During periods of high irrigator pumping and drought, groundwater trigger levels for both the mine and irrigators will require management.

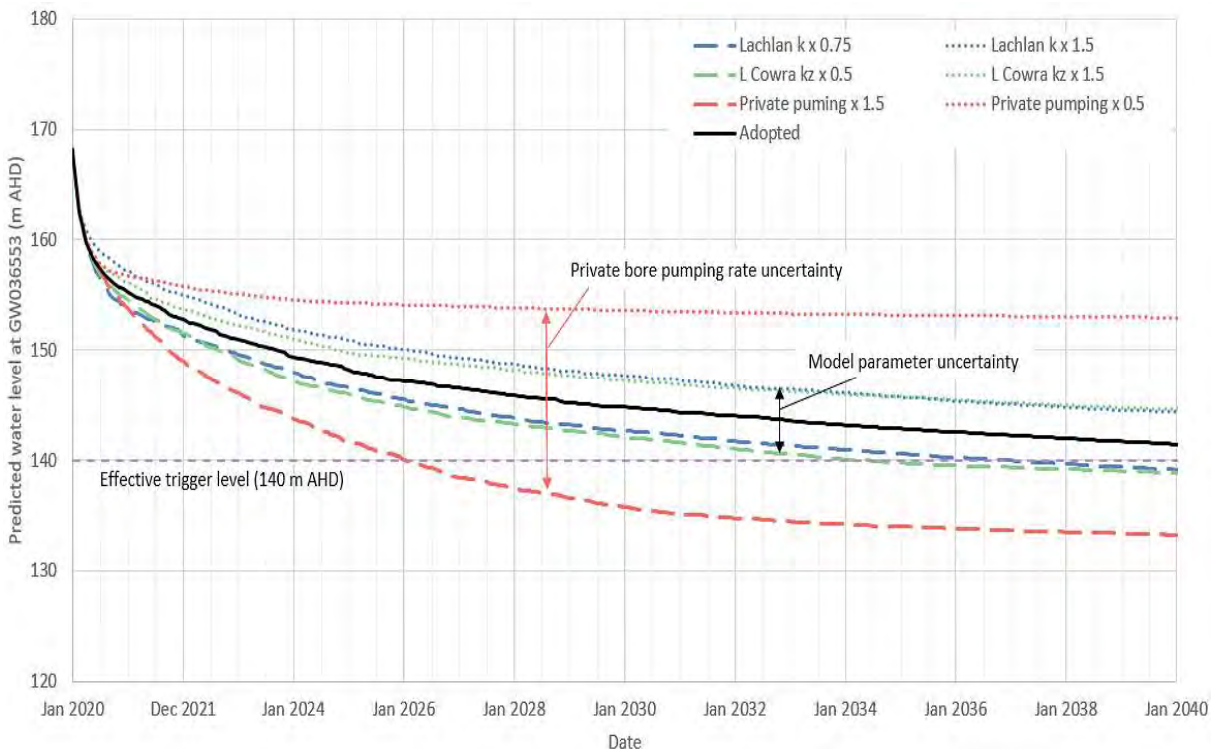

Figure 8-1: Predictive uncertainty for modelled groundwater levels at trigger piezometer GW036553

9. Summary and Conclusions

An existing model has been used to predict groundwater impacts associated with operation of the ESB and BCPB for the CGO Underground Development. Predictive simulation results are based on significant assumptions regarding high-extraction private water bores in the area.

9.1. Predictive Simulation Results

Over the period 1 July 2004 to 31 December 2019, the average total pumping rates at the largest groundwater extraction bores (4.1 ML/day at the BCPB, 2.8 ML/day at the Billabong bores, and 2.7 ML/day at the Maslin bore) have maintained water levels 1.5 m or more above the relevant trigger levels at the three DIW trigger piezometers. Pumping rates for the Billabong and Maslin bores, as used in verification analysis, involve significant assumptions.

Modelling results indicate that the BCPB can pump at a maximum rate of 4.0 ML/day, from 1 January 2020 to 30 June 2040 (with the ESB pumping at 1.5 ML/day), without causing the water level in trigger piezometer GW036553 to fall below the mitigation trigger level of 134 m AHD. The effects of pumping at this rate were also assessed at the locations of monitoring bores GW036597 and GW036611 located 15 km south of the mine borefield. At these locations the incremental effects of pumping from the mine bores at 4.0 ML/d from 1 January 2020 to 30 June 2040 were added to a measure of low recorded groundwater levels at these locations (based on the average of the lowest five events on record). The predicted groundwater levels for the impact of mine water use remained above the trigger levels for these monitoring bores.

Operation of the BCPB and ESB is governed by water levels at trigger piezometer GW036553. Water levels at trigger piezometers GW036597 and GW036611 do not govern the operation of the BCPB and ESB.

The trigger level for GW036553 (located near the mine borefield) is not predicted to be breached under the adopted model conditions, based on extraction at a uniform rate with time.

The response in the southern trigger piezometers is strongly dependent on usage and our information on actual and forecast usage by the irrigators is limited. In particular, the forecast irrigator use does not consider the “self-regulating” approach to pumping when the trigger levels are approached.

Considering the worst case scenario for model parameter uncertainty, the water level at trigger piezometer GW036553 would be predicted to reach the effective trigger level in late 2033. On the other hand, considering the best case scenario for model parameter uncertainty, the water level at GW036553 is predicted to be approximately 4 m higher than the effective trigger level in 2040.

The effects of the uncertainty in the rate of irrigator pumping from Billabong 3/6, Billabong 4 and Maslin are clearly evident. A 50% increase in the future pumping rate from these bores results in the predicted water level at GW036553 reaching the effective trigger level in 2026. This also shows the importance of climate on future groundwater availability. During periods of high irrigator pumping and drought, groundwater trigger levels for both the mine and irrigators will require management.

Maximum drawdowns at the end of the CGO mine life are predicted to be 40 m or less in the Lower Cowra Formation and 61 m or less in the Lachlan Formation within the BCPB. A maximum drawdown of about 32 m (in the Lower Cowra Formation) is modelled for GW029574, the only known water bore installed to a depth within the Lower Cowra Formation and 10 km to the south of the BCPB. However, the bore is 88 m deep and may be able to continue operation if the screen length is sufficiently long and optimally located.

Previous simple numerical transport simulation for Case 1 (where allowance is made for the departure of model drawdown from observation at the trigger bore near the BCPB – GW036553) predicts EC at BLPR1 will increase by about 40% or less, by 30 June 2040, from pre-mining concentrations.

At cessation of BCPB and ESB pumping, groundwater levels at GW036553 are predicted to recover to around 166 m AHD in 10 years (about 30 m below 1998 water levels), and would continue to gradually recover over time, to a level that is dependent on the volume historically pumped, private bore usage following mine closure, and climatic conditions.

9.2. Regulatory Considerations

9.2.1. Licence allocation for the BCPB

The following points summarise our understanding of the licensing situation for the CGO:

- Evolution currently holds 3650 units (ML) / annum in the Upper Lachlan Alluvial Zone 7 Management Zone within the Water Sharing Plan for the Lachlan Unregulated and Alluvial Water Sources 2012.
- Evolution would continue to extract groundwater from the Upper Lachlan Alluvial Water Source in accordance with existing licence entitlements, and in accordance with the contingency strategy as described in Section 8.2.3.

9.2.2. Aquifer Interference Policy

Merrick (2013) states that, according to Principle 14 of the NSW State Groundwater Policy Framework Document, “All activities or works that intersect an aquifer, and are not for the primary purpose of extracting groundwater, need an aquifer interference approval.” Since the BCPB and ESB are for the primary purpose of extracting, and using, groundwater, no aquifer interference approval is needed. However, use of the BCPB and ESB are subject to regulatory requirements according to other legal instruments that may be in force. Specifically, for the BCPB, a contingency strategy and mitigation measures are in place as discussed below.

9.2.3. Lachlan Formation Water Source

Contingency Strategy

The groundwater level in the Lachlan Formation in the BCPB area is monitored on a continuous basis by the DIW using its groundwater monitoring bore on Burcher Road (GW036553). Contingency measures have been developed for implementation when water levels reach an elevation of either 137.5 m AHD (Investigation Trigger Level) or 134 m AHD (Mitigation Trigger Level). These trigger levels were developed in consultation with DIW and other water users within the Bland Creek Palaeochannel, including stock and domestic users and irrigators. The following contingency measures are understood to be associated with each Trigger Level:

- In the event that the groundwater level in GW036553 is below 137.5 m AHD, one or more of the following contingency measures will be implemented in consultation with the DIW:
 - Investigate the groundwater level in the Trigalana bore (GW702286) or any other impacted stock and domestic bores.
 - Determine the pump setting in relevant stock and domestic bores.
 - Determine the drawdown rate in GW702286 and other impacted stock and domestic bores.
 - Develop an impact mitigation plan for impacted stock and domestic bores, and/or set up an alternative water supply for the owner of GW702286 and other owners of stock and domestic bores, if necessary.
- In the event that the groundwater level in GW036553 is below 134 m AHD, one or both of the following contingency measures will be implemented in consultation with the DIW:

- Alter the pumping regime to maintain the water level in the impacted stock and domestic bores.
- Maintain a water supply to the owner/s of impacted stock and domestic bores.

Mitigation Measures

Prior to the drought last decade, stock and domestic water supplies were generally drawn from surface water delivered through the JIL irrigation channel network. The reduced availability and increased cost of this water, driven by reduced rainfall from around 2002 onwards, led to establishment of stock/domestic bores which utilised the Lachlan Formation aquifer. Several consortia were established to share the costs of bore installation and to deliver the water across multiple properties. Barrick (the previous owner of CGO) was independently approached by various parties for assistance in upgrading the pumping systems such that their design capacity could be met independently of the abstraction from the Lachlan Formation. The known schemes are listed below (see Appendix E for locations):

- Moora Moora (GW702262).
- West Plains (GW702100).
- Trigalana (GW702286, also known as Trigalana West).
- Trigalana East.

Each of the schemes is understood to comprise the following key elements:

- A single bore equipped with a submersible pump.
- Above-ground storage tanks located near the bore.
- A surface-mounted pump to pressurise the pipeline system.
- A pipeline system with control valves at the user offtake.

The Muffet bore (GW701958) is understood to have provided stock water on a single property, through a solar-powered pumping system. Other private, single-farm systems are reported to be powered by solar, diesel, and mains powered pumps.

It is understood that the following measures were implemented by Barrick for ameliorating the impacts of pumping at the BCPB on stock/domestic bores:

- From 2006 to 2007:
 - Moora Moora: Replacement of the pump, installation of a new pump to a greater depth and upgrade of the electrical power supply to enable the system to maintain design flow.
 - West Plains and Trigalana: Provision of water through a metered polyethylene pipeline direct to the stock water tanks.
 - Muffet: Replacement of an existing solar powered submersible pump with a new pump of larger capacity, setting of the new pump to a greater depth, and upgrade of the solar panel array to increase its electrical output.
- During 2011:
 - West Plains: The bore failed and Barrick paid for replacement of the bore in mid-2011. The bore was operating by the fourth quarter of 2011.
 - Isolation of the West Plains and West Trigalana schemes from the direct supply of water from the BCPB pipeline (although water could still be supplied in an emergency since the pipelines remain in place).

9.2.4. Cowra Formation Water Source

Modelling results indicate a maximum predicted drawdown of about 32 m at bore GW029574, the only known water bore installed to a depth within the Lower Cowra Formation and within 15 km of the BCPB. It is located 10 km south of BCPB. The bore is 88 m deep and may be able to continue operation if the screen length is sufficiently long and optimally located. If not, contingency measures may be required for this bore.

10. Limitations

Predictive results are subject to the uncertainty inherent in numerical modelling. The numerical model is necessarily a simplification of the real system and relies on calibration to observation data to produce predictive results. The results are estimates only and may differ significantly from future observations. Actual future extraction from the BCPB and ESB may differ from that adopted for predictive simulations.

Further advice on the uses and limitations of this report is presented in the attached document, 'Important information about your Coffey Report'.

11. Recommendations

It is recommended that a statistical analysis be undertaken of the difference between modelled and observed hydrographs (residuals) at DIW trigger piezometers, so that an estimate for an offset to be applied to modelled hydrographs (to accommodate model over prediction) can be obtained for a reasonable probability (say 95% confidence). The probability may need to be negotiated with regulatory agencies. This analysis would require synchronisation of observed water level measurements to modelled output, using interpolation algorithms.

There is uncertainty about historical and future groundwater use by irrigators. As a result, predictions of groundwater level in areas of significant groundwater use for irrigation are uncertain. Mining impacts in these areas associated with proposed future mine operation were assessed. This assessment will need to be reviewed as information about water usage becomes available.

The Warrakimbo bore, located very close to the Maslin bore, is licensed for irrigation and has a large allocation. To match the observed GW036611 hydrograph troughs in November and December 2019, the Maslin bore was estimated to be pumping at 12 ML/day. Previous modelling assumed a pump capacity of 7 ML/day. The Warrakimbo bore may have been in use during these periods of low water levels and it is recommended that potential water usage from this bore is obtained.

Billabong 5 was completed on 23 December 2008 as a replacement for Billabong 1 and 2. The potential for this bore to have been used since 2008, or to be used in the future, is high. To match the observed GW036597 hydrograph troughs in March and November 2019, Billabong bores 4 and 6 were estimated to be pumping at 5 ML/day, a total rate of 10 ML/day. Previous modelling assumed a pump capacity of 4 ML/day. The Billabong 5 bore may have been in use during these periods of low water levels and it is recommended that potential water usage from this bore is obtained.

The numerical model requires updating and verification on a regular basis for it to be used as an effective predictive tool. Model recalibration may be necessary from time to time, using additional observations as they are collected.

12. References

- Anderson J, Gates G, and Mount TJ. 1993. Hydrogeology of the Jemalong and Wyldes Plains Irrigation Districts. Technical Services Division, Department of Water Resources. Report TS93.045. August.
- Australian and New Zealand Environment and Conservation Council. 1995. National Water Quality Management Strategy Guidelines for Groundwater Protection in Australia.
- Barnett B, Townley LR, Post V, Evans RE, Hunt RJ, Peeters L, Richardson S, Werner AD, Knapton A and Boronkay A. 2012. Australian groundwater modelling guidelines, Waterlines report, National Water Commission, Canberra.
- British Institute of Hydrology. 1980a. Research report, v. 1 of Low flow studies: Wallingford, United Kingdom, Institute of Hydrology, 42 p.
- British Institute of Hydrology. 1980b. Catchment characteristic estimation manual, v. 3 of Low flow studies: Wallingford, United Kingdom, Institute of Hydrology, 27 p.
- Carrara EA, Weaver TR, Cartwright I, and Cresswell RG. 2004. 14C and 36Cl as indicators of groundwater flow, Bland Catchment, NSW. Proceedings of the Eleventh International Symposium on Water-Rock Interaction WRI-11, Saratoga Springs, NY, 27 June - 2 July 2004. Pages:377-381
- Coffey Geosciences Pty Ltd. 2006. Cowal Gold Mine Groundwater Supply Modelling Study: Model Calibration. Report S21910/02AK prepared for Barrick Australia Limited. October.
- Coffey Geotechnics Pty Ltd. 2013. Final Hydrogeological Assessment, CGO Extension Modification. Report GEOTLCOV21910AW-AI, prepared for Barrick. September.
- Coffey Partners International Pty Ltd. 1994. Groundwater Modelling Study, Jemalong Wyldes Plain. Report G375/2-AB. November.
- Coffey Partners International Pty Ltd. 1995. Outside Borefield Feasibility Study for Lake Cowal Project. Report No. G255/24-AJ. February.
- Coffey Services Australia Pty Ltd. 2016. Cowal Gold Operations Mine Life Modification, Bland Creek Palaeochannel Borefield and Eastern Saline Borefield Groundwater Assessment. Report GEOTLCOV21910BG-BCPB, prepared for Evolution Mining (Cowal) Pty Ltd. November.
- Coffey Services Australia Pty Ltd. 2018. Cowal Gold Operations Processing Rate Modification (MOD 14), Bland Creek Palaeochannel Borefield and Eastern Saline Borefield Groundwater Assessment. Report 754-SYDGE206418-BCPB, prepared for Evolution Mining (Cowal) Pty Ltd. March.
- Coffey Services Australia Pty Ltd. 2020. Cowal Gold Operation Groundwater Monitoring Review 2019. Report 754-SYDGE270760-AA. April.
- Cook PG, Leaney FW, and Jolly ID. 2001. Groundwater recharge in the Mallee Region, and salinity implications for the Murray River – A review. CSIRO Land and Water Technical Report 45/01. November.
- Cooper HH and Jacob CE. 1946. A generalized graphical method for evaluating formation constants and summarizing well field history. American Geophysical Union Transcripts, Volume 27, p. 526 - 534.
- Groundwater Consulting Services Pty Ltd. 2006. Jemalong Water Supply Borefield Installation and Testing, Cowal Gold Project, West Wyalong, New South Wales. Report compiled for Barrick Australia Limited. August.

- Harbaugh AW, Banta ER, Hill MC, and McDonald MG. 2000. MODFLOW-2000, The US Geological Survey Modular Groundwater Model – User Guide to Modularization Concepts and the Ground-water Flow Process. U.S. Geological Survey Open-File Report 00-92.
- Hawkes GE. 1998. Hydrogeology of the Proposed Lake Cowal Gold Mine, NSW. Unpublished MSc Thesis. University of Technology, Sydney.
- Merrick NP. 2013. How does the Aquifer Interference Policy affect groundwater assessments? Presentation to NSW IAH, 12 March 2013.
- NSW Department of Environment and Conservation. 2007. Guidelines for the Assessment and Management of Groundwater Contamination.
- NSW Department of Land and Water Conservation. 1997. The NSW State Groundwater Policy Framework Document.
- NSW Department of Land and Water Conservation. 1998. The NSW Groundwater Quality Protection Policy – A Component Policy of the NSW State Groundwater Policy.
- NSW Department of Land and Water Conservation. 2002. The NSW State Groundwater Dependent Ecosystems Policy – A Component Policy of the NSW State Groundwater Policy Framework Document.
- NSW Department of Primary Industries Office of Water. 2012. NSW Aquifer Interference Policy: NSW Government policy for the licensing and assessment of aquifer interference activities. September 2012.
- NSW Department of Primary Industries Water. 2016. Water Sharing Plan for the Lachlan Unregulated and Alluvial Water Sources – Background document for amended plan 2016. First published July 2012. Updated June 2016.
- Ross JB. 1982. Interim report on the Water Resources Commission investigation – Drilling and current observation bore network in the Upper Lachlan Valley. WRC Hydrogeological Report 1982/2.
- SNC-Lavalin Australia. 2003. Cowal Gold Project Geotechnical Investigation Report. Report 334371-0000-4GRA-0001 prepared for Barrick Gold of Australia. December.
- Van der Lely A. 1993. Channel seepage from Warroo Main Canal, Jemalong Irrigation District. NSW Department of Water Resources (Murrumbidgee Region) Technical Report No. 93/04. October.
- Wahl KL and Wahl TL. 1995. Determining the flow of Comal Springs at New Braunfels, Texas, in Proceedings of Texas Water 95, August 16–17, 1995, San Antonio, Tex.: American Society of Civil Engineers, p. 77-86.
- Williams BG. 1993. The shallow groundwater hydrology of the Jemalong – Wyldes Plains Irrigation Districts. NSW Department of Agriculture. March.

Important information about your Coffey Report

As a client of Coffey you should know that site subsurface conditions cause more construction problems than any other factor. These notes have been prepared by Coffey to help you interpret and understand the limitations of your report.

Your report is based on project specific criteria

Your report has been developed on the basis of your unique project specific requirements as understood by Coffey and applies only to the site investigated. Project criteria typically include the general nature of the project; its size and configuration; the location of any structures on the site; other site improvements; the presence of underground utilities; and the additional risk imposed by scope-of-service limitations imposed by the client. Your report should not be used if there are any changes to the project without first asking Coffey to assess how factors that changed subsequent to the date of the report affect the report's recommendations. Coffey cannot accept responsibility for problems that may occur due to changed factors if they are not consulted.

Subsurface conditions can change

Subsurface conditions are created by natural processes and the activity of man. For example, water levels can vary with time, fill may be placed on a site and pollutants may migrate with time. Because a report is based on conditions which existed at the time of subsurface exploration, decisions should not be based on a report whose adequacy may have been affected by time. Consult Coffey to be advised how time may have impacted on the project.

Interpretation of factual data

Site assessment identifies actual subsurface conditions only at those points where samples are taken and when they are taken. Data derived from literature and external data source review, sampling and subsequent laboratory testing are interpreted by geologists, engineers or scientists to provide an opinion about overall site conditions, their likely impact on the proposed development and recommended actions. Actual conditions may differ from those inferred to exist, because no professional, no matter how qualified, can reveal what is hidden by earth, rock and time. The actual interface between materials may be far more gradual or abrupt than assumed based on the facts obtained. Nothing can be done to change the actual site conditions which exist, but steps can be taken to reduce the impact of unexpected conditions. For this reason, owners should retain the services of Coffey through the development stage, to identify variances, conduct additional tests if required, and recommend solutions to problems encountered on site.

Your report will only give preliminary recommendations

Your report is based on the assumption that the site conditions as revealed through selective point sampling are indicative of actual conditions throughout an area. This assumption cannot be substantiated until project implementation has commenced and therefore your report recommendations can only be regarded as preliminary. Only Coffey, who prepared the report, is fully familiar with the background information needed to assess whether or not the report's recommendations are valid and whether or not changes should be considered as the project develops. If another party undertakes the implementation of the recommendations of this report there is a risk that the report will be misinterpreted and Coffey cannot be held responsible for such misinterpretation.

Your report is prepared for specific purposes and persons

To avoid misuse of the information contained in your report it is recommended that you confer with Coffey before passing your report on to another party who may not be familiar with the background and the purpose of the report. Your report should not be applied to any project other than that originally specified at the time the report was issued.

Interpretation by other design professionals

Costly problems can occur when other design professionals develop their plans based on misinterpretations of a report. To help avoid misinterpretations, retain Coffey to work with other project design professionals who are affected by the report. Have Coffey explain the report implications to design professionals affected by them and then review plans and specifications produced to see how they incorporate the report findings.

Data should not be separated from the report

The report as a whole presents the findings of the site assessment and the report should not be copied in part or altered in any way. Logs, figures, drawings, etc. are customarily included in our reports and are developed by scientists, engineers or geologists based on their interpretation of field logs (assembled by field personnel) and laboratory evaluation of field samples. These logs etc. should not under any circumstances be redrawn for inclusion in other documents or separated from the report in any way.

Geoenvironmental concerns are not at issue

Your report is not likely to relate any findings, conclusions, or recommendations about the potential for hazardous materials existing at the site unless specifically required to do so by the client. Specialist equipment, techniques, and personnel are used to perform a geoenvironmental assessment. Contamination can create major health, safety and environmental risks. If you have no information about the potential for your site to be contaminated or create an environmental hazard, you are advised to contact Coffey for information relating to geoenvironmental issues.

Rely on Coffey for additional assistance

Coffey is familiar with a variety of techniques and approaches that can be used to help reduce risks for all parties to a project, from design to construction. It is common that not all approaches will be necessarily dealt with in your site assessment report due to concepts proposed at that time. As the project progresses through design towards construction, speak with Coffey to develop alternative approaches to problems that may be of genuine benefit both in time and cost.

Responsibility

Reporting relies on interpretation of factual information based on judgement and opinion and has a level of uncertainty attached to it, which is far less exact than the design disciplines. This has often resulted in claims being lodged against consultants, which are unfounded. To help prevent this problem, a number of clauses have been developed for use in contracts, reports and other documents. Responsibility clauses do not transfer appropriate liabilities from Coffey to other parties but are included to identify where Coffey's responsibilities begin and end. Their use is intended to help all parties involved to recognise their individual responsibilities. Read all documents from Coffey closely and do not hesitate to ask any questions you may have.

Appendix A - Specific Capacity Analysis

Specific capacity (S_c) is the pumping rate divided by the drawdown in the pumped bore at a specified time. The time is usually taken as 1 day, since most tests are of this duration.

An analysis is undertaken using tests where temporal drawdown data are available. For each test, S_c is calculated at 1 day. Transmissivity (T_j) is interpreted from temporal drawdown at the pumped bore using the Cooper and Jacob (1946) method for confined conditions. The quantity $(T_j - S_c)/T_j$ is then plotted against pumping rate and the relationship approximated with a trendline. This relationship is then used to convert S_c for tests where temporal drawdown is unavailable (the majority of government records). The method assumes the bores in the database are approximately similar in hydraulic behaviour (well loss component), and that dissimilarities in screened lithology are minor.

Table 1 lists the pumping tests (from 9 bores) used to find a relationship, and Figure 1 shows the resulting relationship. For some tests, the drawdown at 1 day was either unavailable or could not be estimated. This adds additional approximation to the fitted line.

Table 1. Bore tests used for specific capacity analysis.

Bore	Screened Formation	Registration Number	Pumping Rate (m ³ /day)	Test Duration (hours)	T _j * (m ² /day)	Interpretation	Specific Capacity			(T _j -S _c)/T _j
							Draw-down (m)	Time	S _c (m ² /day)	
CGO BCPB Bore 1	Lachlan	GW701660	2894	0.4	662	Coffey 2008	9.0	1 day	322	0.514
CGO BCPB Bore 2	Lachlan	GW701659	4752	24	870	Coffey 2008	9.1	1 day	522	0.400
CGO BCPB Bore 3	Lachlan	GW701658	4752	24	1242	Coffey 2008	12.1	1 day	393	0.684
CGO BCPB Bore 4	Lachlan	GW701657	4752	24	870	Coffey 2008	14.5	1 day	328	0.623
BLRP2 Test 1	Lachlan		2678	48	460	Coffey 1994 (G255/18-AD)	11.1	1 day	241	0.476
BLRP2 Test 2	Lachlan		5702	168	482	Coffey 1995 (G255/24-AJ)	19.0	1 day	300	0.377
Duff 2009	Lower Cowra	GW702230	1452	91	98	GCS 2010 (BARR010)	23.0	End	63	0.356
Duff 2004	Lower Cowra	GW702230	1597	24	104	Coffey 2008	34.6	1 day	46	0.556
PBA	Upper Cowra		173	53	248	Coffey 1994 (G375/1-AF)	1.0	End	173	0.303
PBB	Upper Cowra		86	5	243	Coffey 1994 (G375/1-AF)	0.4	End	237	0.023
PBC	Upper Cowra		51	44	76	Coffey 1994 (G375/1-AF)	0.8	End	61	0.203

*T_j = Transmissivity using Cooper Jacob (1946) method.

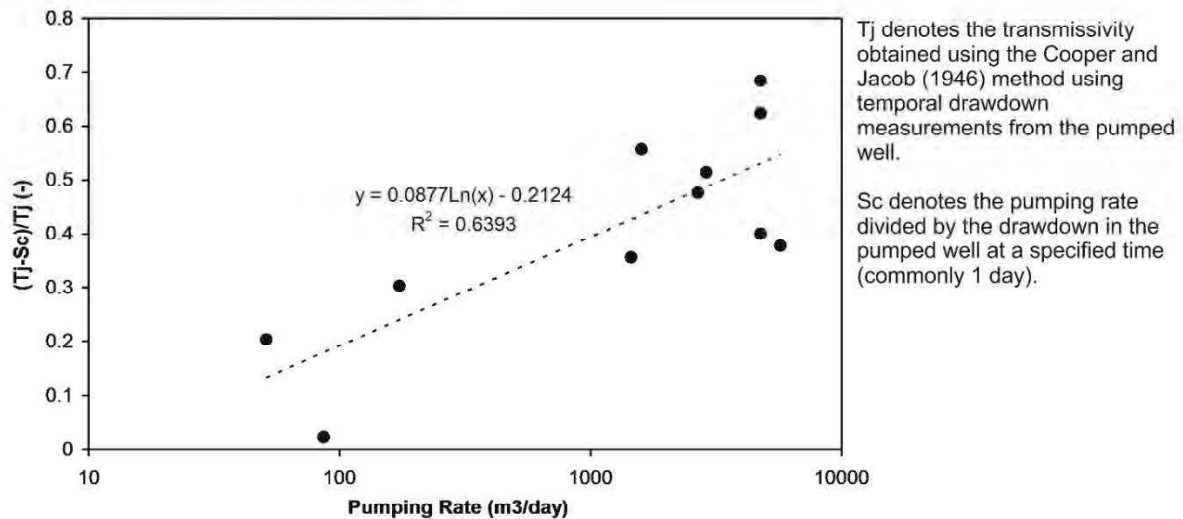
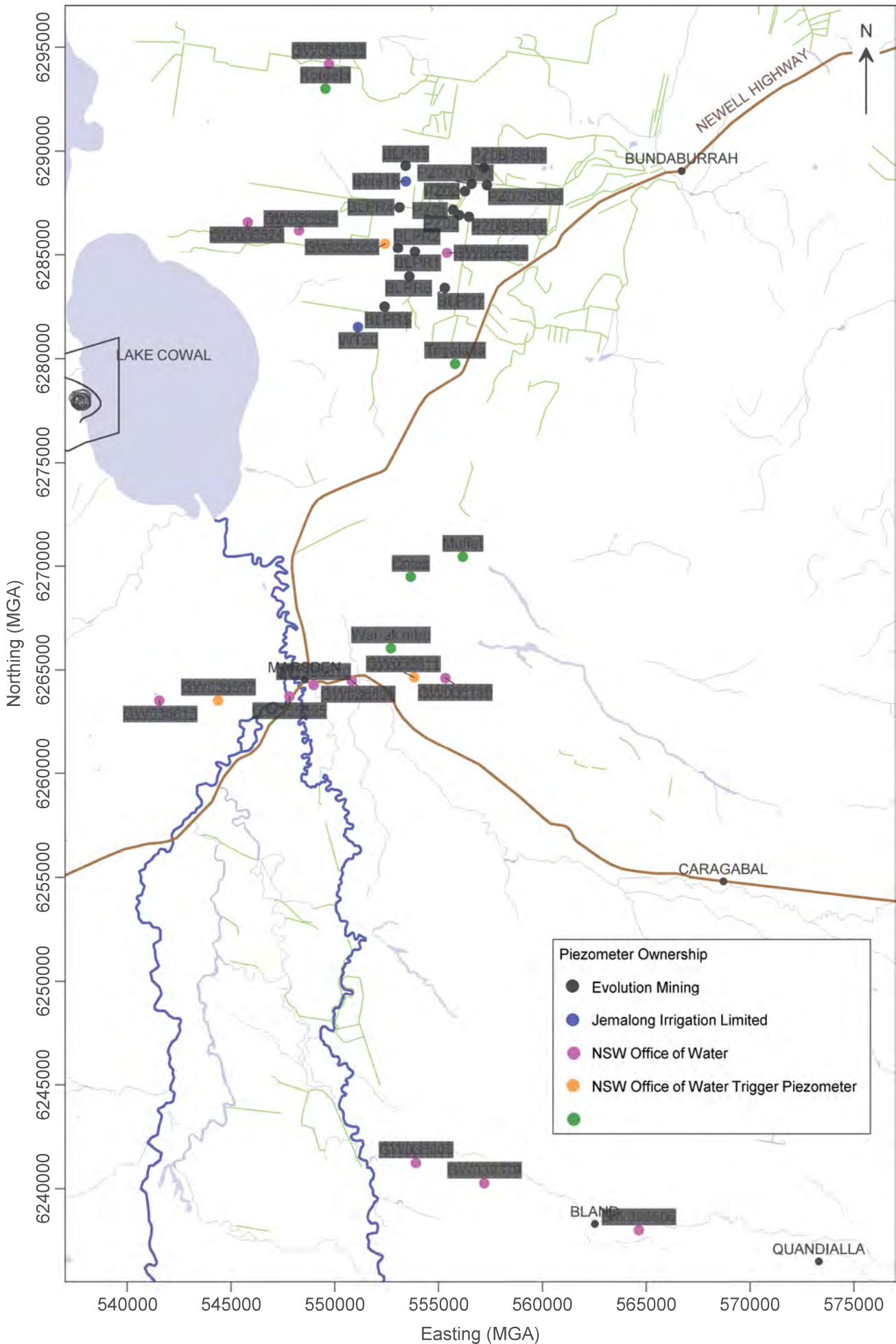

Figure 1. Results of specific capacity analysis for tests in Table 1.

Appendix B - Groundwater Monitoring Network

Bland Creek Palaeochannel Monitoring Piezometer Network



Bland Creek Palaeochannel Monitoring Bore Network

Piezometer / Bore	Owner	Collar Elevation (mAHD)	Easting (mMGA)	Northing (mMGA)	Stratum	Screen (mbgl)		Comment
						From	To	
BLPR1-Ln	Evolution	211.14	553858	6285166	Ln	102	110	BCPB monitoring
BLPR2-Ln	Evolution	209.16	553044	6285330	Ln	106	126	BCPB monitoring
BLPR3-LC	Evolution	210.50	553417	6289305	LC	72	84	BCPB monitoring
BLPR4-Ln	Evolution	210.77	553117	6287305	Ln	94	110	BCPB monitoring
BLPR5-Ln	Evolution	209.61	552392	6282505	Ln	107	120	BCPB monitoring
BLPR6-Ln	Evolution	210.09	553592	6283955	Ln	97	115	BCPB monitoring
BLPR7-Ln	Evolution	210.47	555292	6283405	Ln	103	133	BCPB monitoring
PZ01-UC/LC	Evolution	210.71	555703	6287188	UC/LC	20	80	ESB Monitoring. Decommissioned May 2012.
PZ02-UC/LC	Evolution	210.69	556267	6288075	UC/LC	18	78	ESB Monitoring.
PZ05-UC/LC	Evolution	211.05	555984	6286935	UC/LC	18	78	ESB Monitoring.
PZ06	Evolution	212.09	557239	6289189				ESB Monitoring. Screen interval unknown. Probably UC/LC or LC.
PZ07	Evolution	211.80	557343	6288365				ESB Monitoring. Screen interval unknown. Probably UC/LC or LC.
PZ08	Evolution	210.97	556465	6286840				ESB Monitoring. Screen interval unknown. Probably UC.
PZ09-UC	Evolution	211.19	556580	6288433	UC	13	16	ESB Monitoring
PZ10-LC	Evolution	211.19	556584	6288435	UC/LC	48	51	ESB Monitoring
PZ11-LC	Evolution	211.33	556588	6288437	LC	60	64	ESB Monitoring
SB03	Evolution	211.57	557116	6289198	UC/LC	46	64	ESB Monitoring (outfitted as pumping bore but not pumped)
SB04	Evolution	211.68	557324	6288376	LC	59	65	ESB Monitoring (outfitted as pumping bore but not pumped)
SB05	Evolution	211.06	556447	6286849	LC	58	64	ESB Monitoring (outfitted as pumping bore but not pumped)
Bore16-UC	JIL	211.06	553425	6288550	UC	Water table		Screen interval unknown. Straddles water table.
WT50-UC	JIL	208.56	551121	6281522	UC	Water table		Screen interval unknown. Straddles water table.
GW036524-UC	DIW	207.37	546337	6286862	UC	15	17	Backfilled 89 m. Water levels appear to be representative.
GW036553-Ln	DIW	209.33	552434	6285773	Ln	118	126	
GW036594-LC	DIW	208.79	549558	6286186	LC	69	71	Pipes in same drillhole, but SWLs not the same.
GW036594-UC	DIW	208.79	549558	6286186	UC	11	15	Pipes in same drillhole, but SWLs not the same.
GW036595-LC	DIW	209.32	547929	6263905	LC	85	87	Backfilled 45 m. SWLs appear to be representative.
GW036596-LC	DIW	209.27	550938	6264661	LC	64	66	Pipes in separate drillholes.

Piezometer / Bore	Owner	Collar Elevation (mAHD)	Easting (mMGA)	Northing (mMGA)	Stratum	Screen (mbgl)		Comment
						From	To	
GW036596-Ln	DIW	209.00	550938	6264661	Ln	85	87	Pipes in separate drillholes.
GW036597-Ln	DIW	209.81	544505	6263713	Ln	95	99	Pipes in same drillhole. SWLs same as 36597-LC. Only Ln screen used.
GW036605-Ln	DIW	221.11	554028	6241420	Ln	80	86	
GW036606-Ln	DIW	234.18	564753	6238189	Ln	99	105	
GW036609-Ln	DIW	210.92	554624	6285396	Ln	106	113	
GW036610-LC	DIW	209.33	549088	6264456	LC	64	68	Backfilled 45 m. Water levels appear to be representative.
GW036611-Ln	DIW	209.09	553937	6264823	Ln	107	113	
GW036613-LC	DIW	213.41	541663	6263705	LC	35	45	Backfilled 33 m. Screen in UC but SWLs interpreted as LC.
GW036700-LC	DIW	209.03	555433	6264788	LC	65	75	No backfill.
GW039379-Ln	DIW	223.99	557312	6240441	Ln	74	100	Directly coincident with 36604-Ln (36604-Ln not used).
GW090093-LC	DIW	210.19	549832	6294377	LC	60	66	Pipes in separate drillholes.
GW090093-Ln	DIW	210.12	549832	6294377	Ln	130	136	Pipes in separate drillholes.
GW090093-UC	DIW	210.05	549832	6294377	UC	5	11	Pipes in separate drillholes.
Coles (GW701579)	Private	209.20	553767	6269660	Ln	107	110	
Koreela (GW702262)	Private	212.80	549449	6293272	Ln	117	125	Also in model as a pumping bore.
Muffet (GW701958)	Private	209.00	556272	6270630	Ln	88	93	Also in model as a pumping bore.
Trigalana (GW702286)	Private	208.30	555900	6279959	Ln	102	113	Also in model as a pumping bore.
Warrakimbo (GW701681)	Private	208.00	552812	6266221	Ln			Very close to Maslin Pumping Bore.

Glossary: JIL denotes Jemalong Irrigation Limited. mbgl denotes metres below ground level. UC denotes Upper Cowra Formation. LC denotes Lower Cowra Formation. Ln denotes Lachlan Formation. SWL denotes standing water level.

Appendix C – Interpolated Hydraulic Head Surfaces

Interpolated Hydraulic Head Surfaces for the Upper Cowra Formation

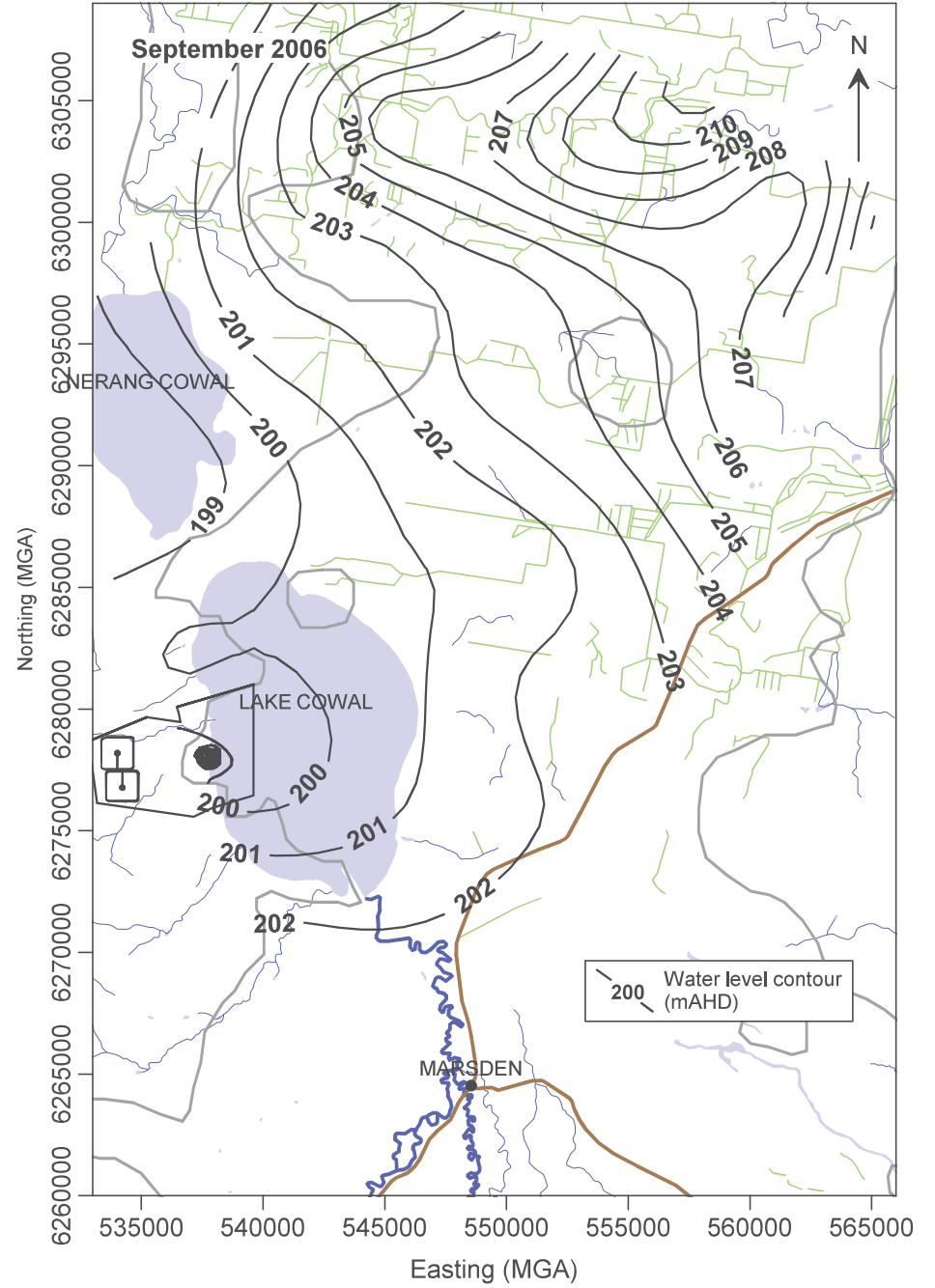
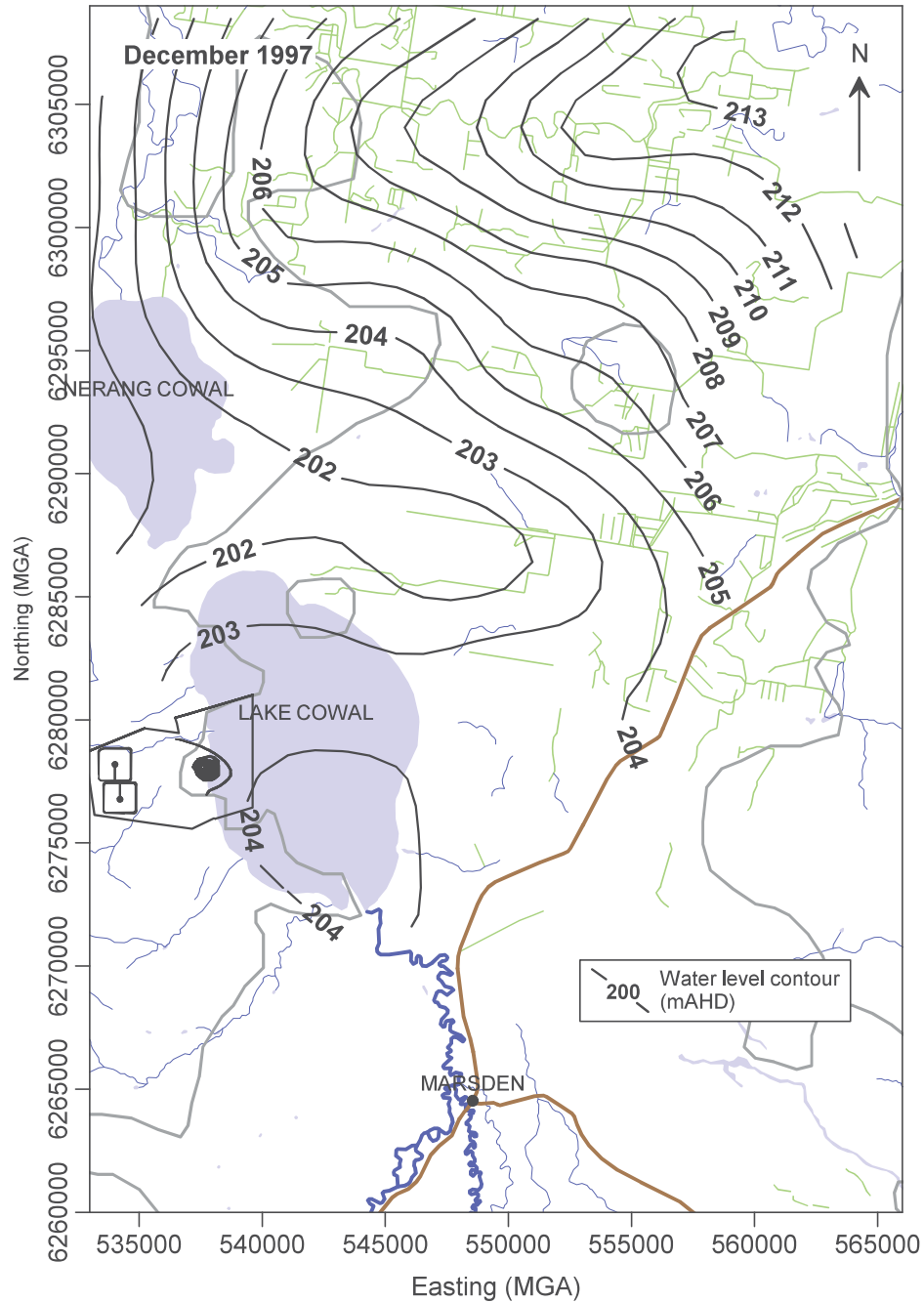

Interpolated Hydraulic Head Surfaces for the Lower Cowra Formation

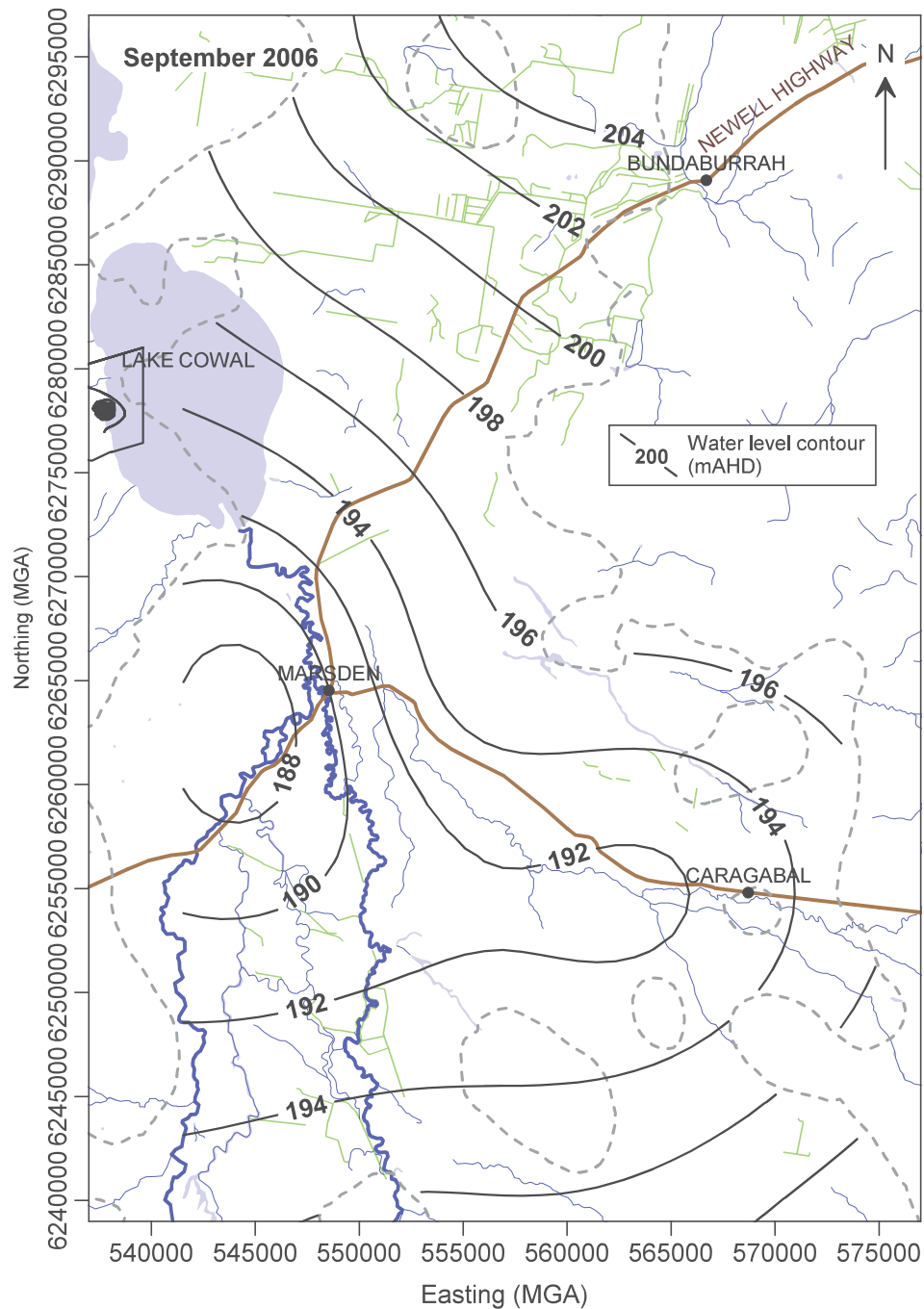
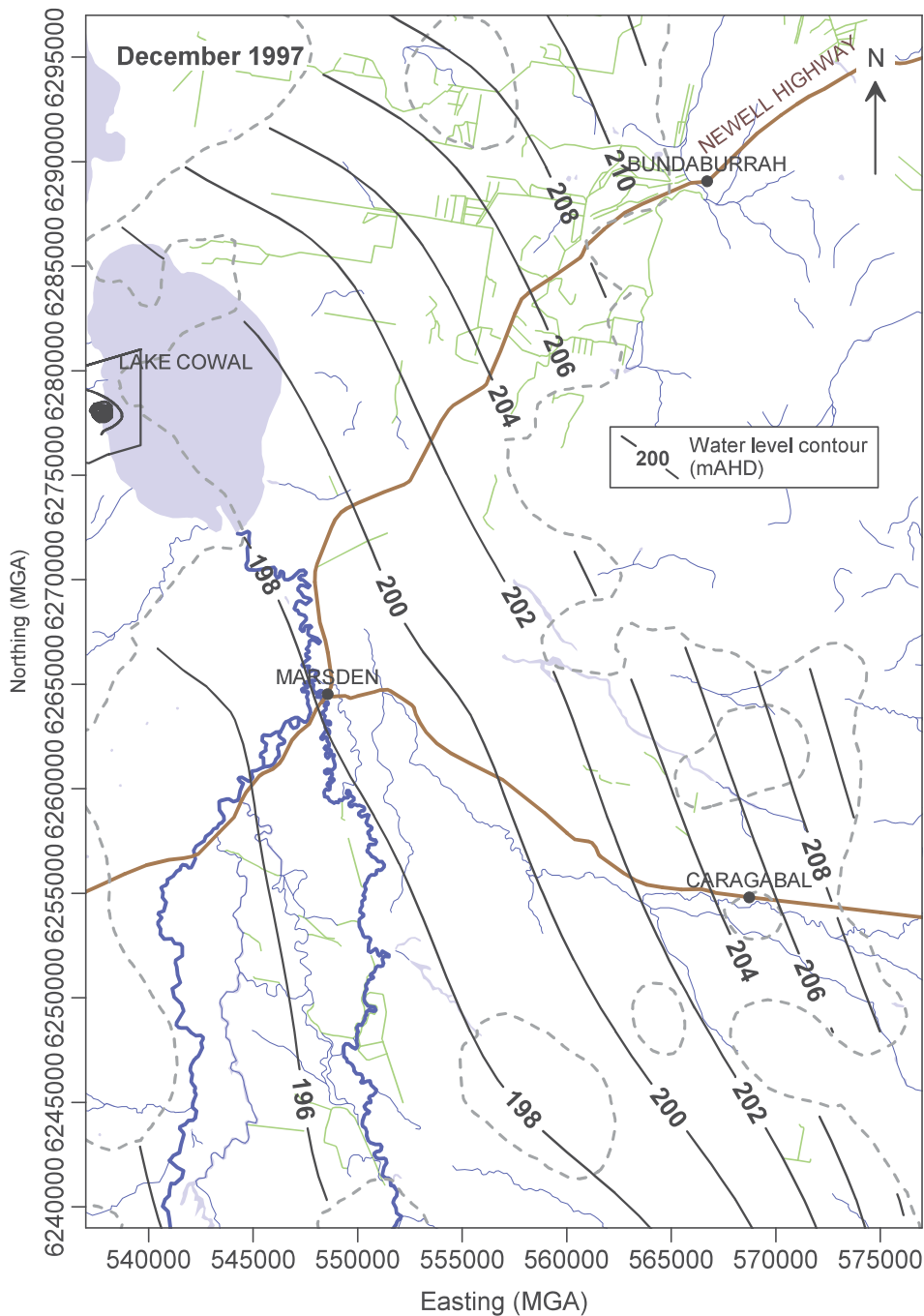

Interpolated Hydraulic Head Surfaces for the Lachlan Formation

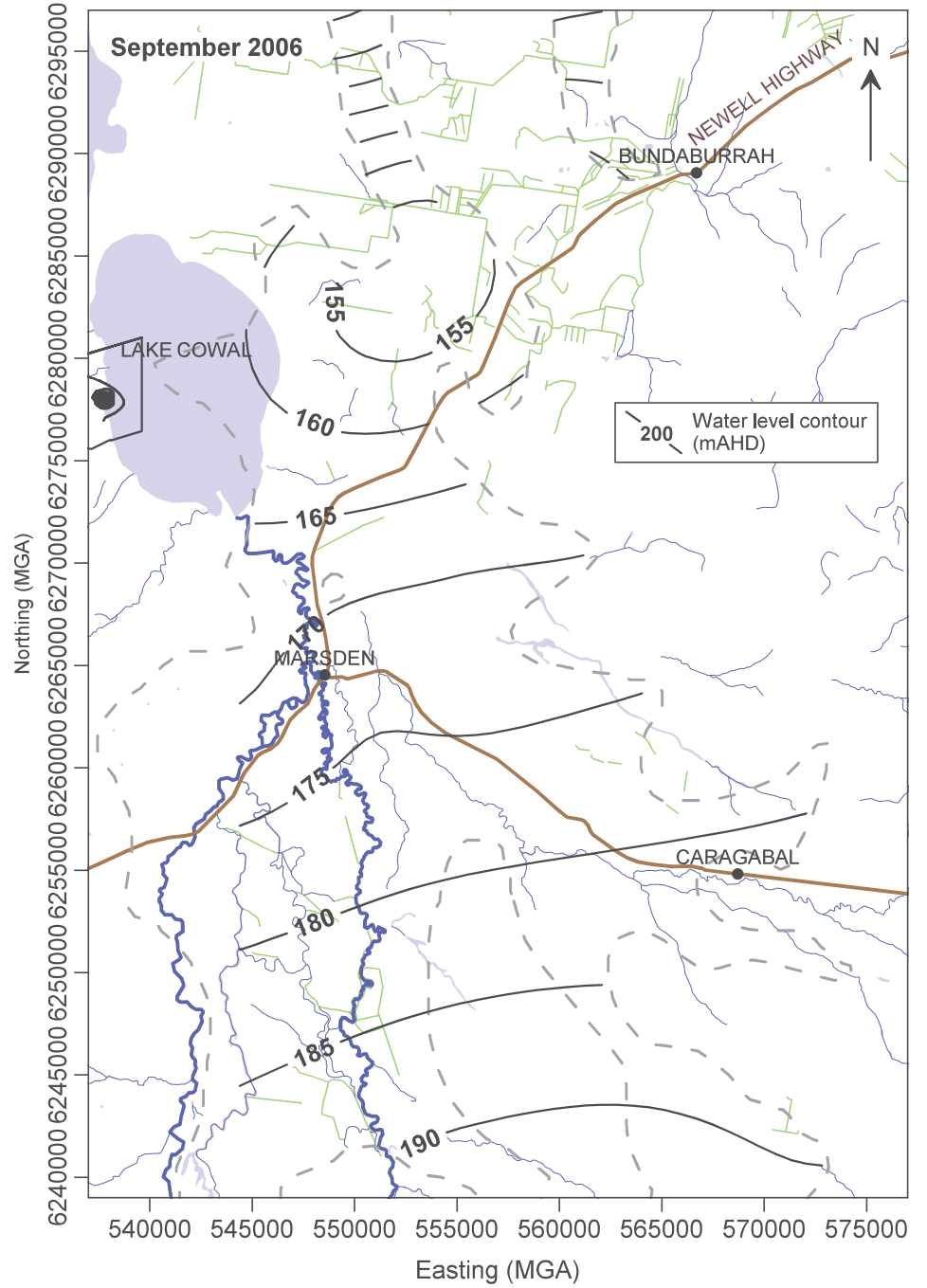
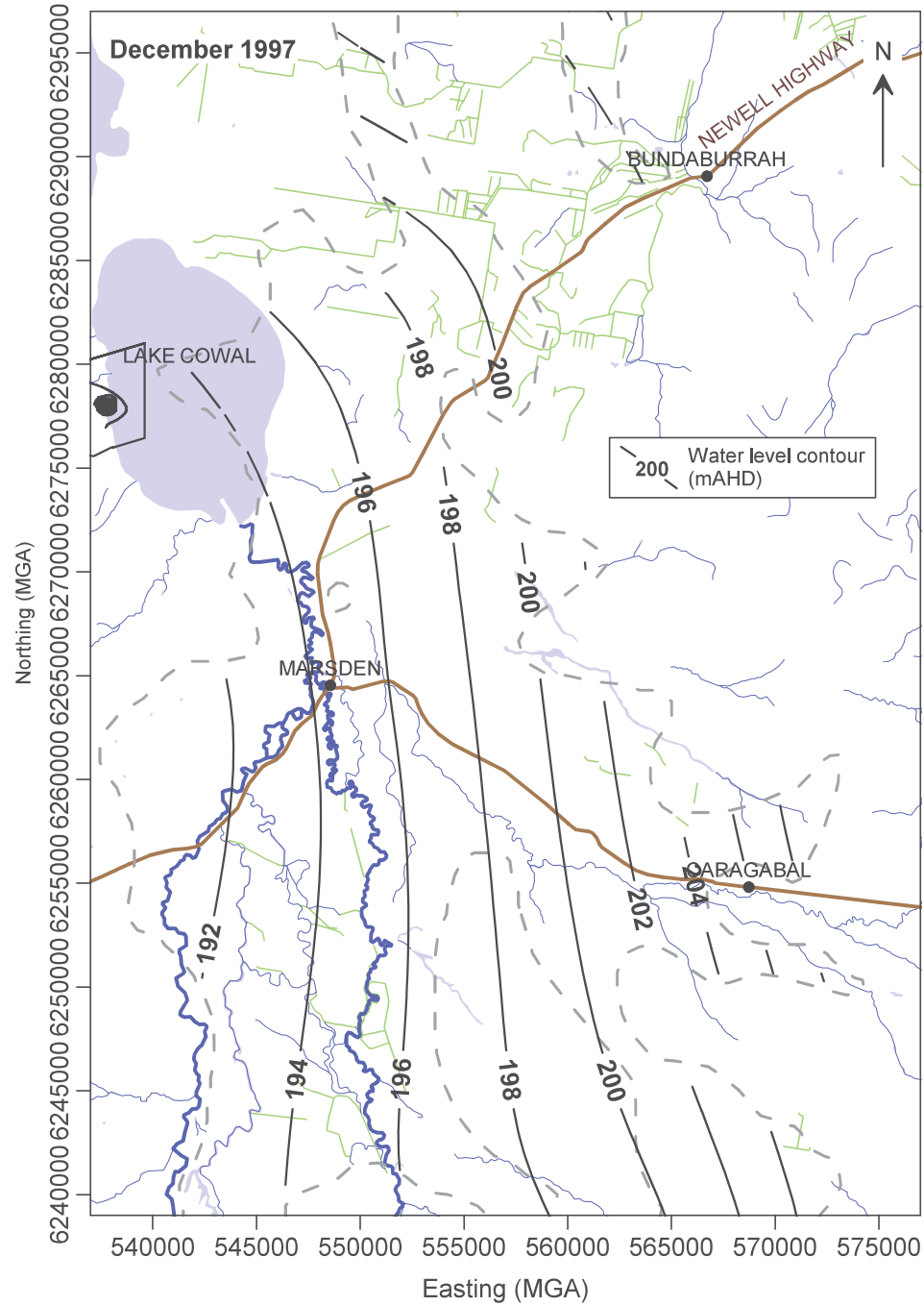

Appendix D - Groundwater Electrical Conductivity Averages

Groundwater Electrical Conductivity Database

Bore	Log-Average EC (uS/cm)	Average EC minus one standard deviation* (uS/cm)	Average EC plus one standard deviation* (uS/cm)	Depth (mbgl)	Data Source
BLPR1 (2004 to 2016)	1933	1848	2023	106	BLPR series averages. Barrick / EM.
BLPR2 (2004 to 2016)	2400	1733	3323	116	
BLPR3 (2004 to 2016)	4979	4810	5153	78	
BLPR4 (2005 to 2016)	2038	1878	2211	102	
BLPR5 (2005 to 2016)	2473	2305	2653	114	
BLPR6 (2004 to 2016)	1917	1831	2007	106	
BLPR7 (2004 to 2016)	1826	1598	2086	118	
P414B (2004 to 2008)	41055	38554	43720	13	Mine Site averages. Barrick / EM.
P417B (2004 to 2008)	32621	29238	36395	11	
P418B (2004 to 2008)	44208	41971	46564	13	
PDB1B (2004 to 2008)	49494	48600	50404	17	
PZ02 (2010 to 2016)	26170	24688	27741	48	ESB averages. Barrick / EM.
PZ05 (2010 to 2016)	6064	4114	8937	48	
PZ09 (2013 to 2016)	24866	23188	26666	15	
PZ10 (2013 to 2016)	9921	8544	11519	50	
PZ11 (2013 to 2016)	13444	11896	15193	62	
SB01 (2011 to 2012)	13258	12404	14171	60	
SB02 (2011 to 2012)	24150	23577	24737	56	
BCPB Bore1	2210			98	BCPB Pumping Bores 1 to 4. Barrick / EM.
BCPB Bore2	2060			90	
BCPB Bore3	1950			94	
BCPB Bore4	3690			93	
BLPR2	1350			116	Coffey report G255/18-AD (1994). Sampled 6 Jan 1994.
BLPR2	1500			116	
BLPR2	1550			116	
BLPR2	1540			116	
BLPR4	2020			102	
BLPR5	610			114	
BLPR7	1820			118	
GW036524	50300			15	Government Piezometers (Anderson et al. 1993 and government records).
GW036528	35100			10	
GW036528	22700			38	
GW036528	10570			51	
GW036528	9990			51	
GW036551	35900			4	
GW036551	24700			27	
GW036551	2750			40	
GW036552	11000			33	
GW036552	615			64	
GW036552	1451			101	
GW036553	2100			85	
GW036553	1850			121	
GW036553	1846			121	
GW036554	17000			13	
GW036554	1050			43	
GW036554	351			56	
GW036563	39600			19	
GW036594	45600			13	
GW036594	27400			70	
GW036595	14490			86	
GW036595	14300			86	
GW036596	3100			85	
GW036597	544			18	
GW036597	2370			78	
GW036597	1864			95	
GW036609	1990			106	
GW036610	14550			64	
GW036611	1857			109	
GW036611	1655			109	
GW036613	31700			48	

Green shading indicates single measurement only.

* in log space.

Appendix E - Pumping Bores

Bland Creek Palaeochannel Pumping Bores

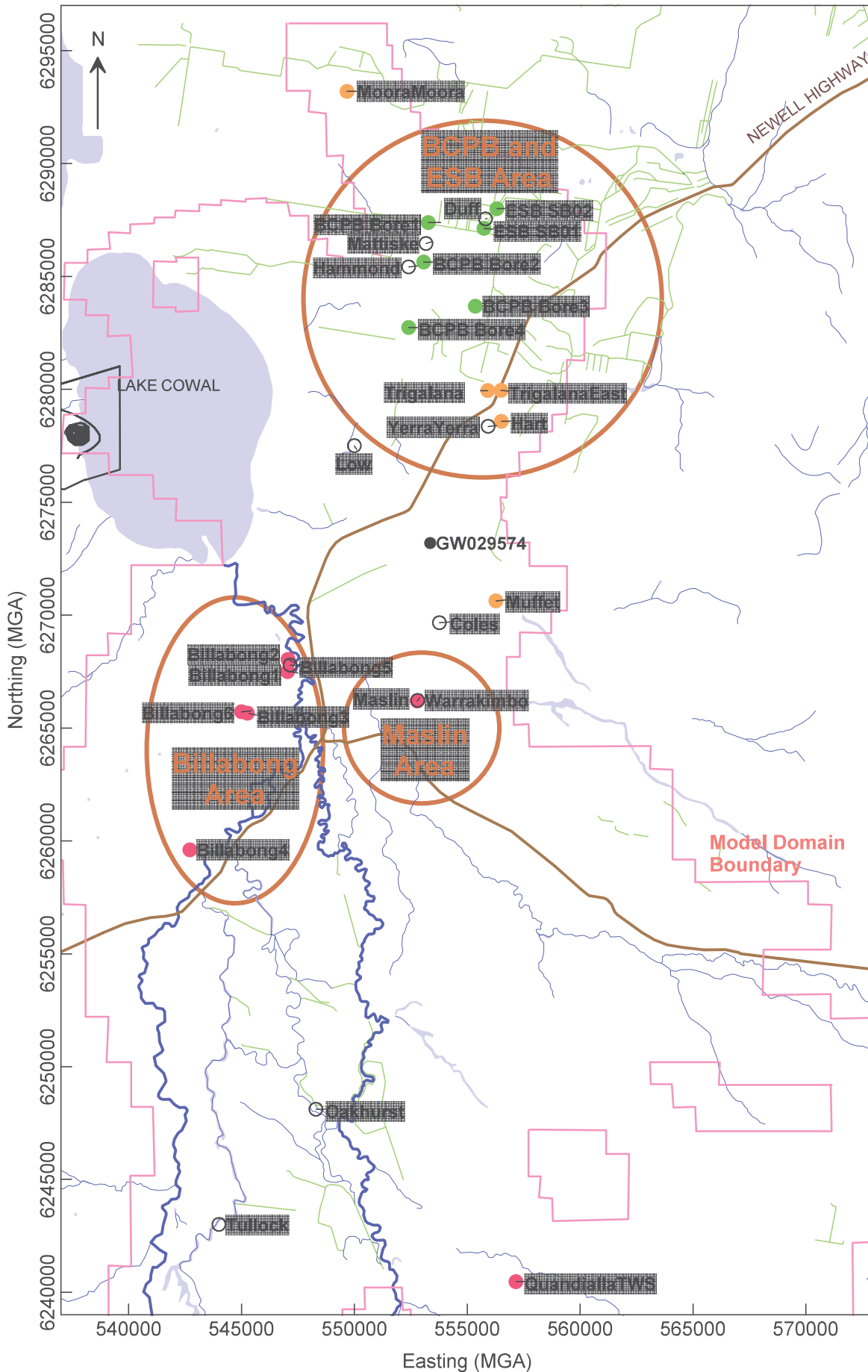

- EM CGO bore (active in model).
- Private bore active in model. Usage data available to June 2010, or decommissioning, whichever earlier (except for Billabong 1, where supplied usage data ends June 2004, but bore was decommissioned in March 2006).
- Private bore active in model. No usage data available but necessarily included in model (from 2007) for calibration and predictive periods. Usage estimates supplied by Lachlan Valley Users Group.
- Private bore inactive in model (no usage data available).

Bland Creek Palaeochannel Pumping Bore Manifest (excludes basic rights bores and includes only those in the model domain).

Table 1. Active Pumping Bores in the Model Domain.

Bore Number and/or Name	Owner	Easting (m MGA)	Northing (m MGA)	Ground Elevation (m AHD)	Collar Elevation (m AHD)	Screen Interval (m bgl)		Screened Stratum	Allocation (ML/year)	Comment
						From	To			
Bore1 (GW701660)	Evolution	553276	6287386	209.7	210.4	95	116	Ln	3650	BCPB. Commenced 2004.
Bore2 (GW701659)		553071	6285635	208.7	209.4	92	125	Ln		
Bore3 (GW701658)		555360	6283678	209.4	210.1	107	128	Ln		
Bore4 (GW701657)		552408	6282736	208.5	209.2	108	117	Ln	ESB. Commenced February 2010	
SB01 (GW703944)		555740	6287128	210.7	211.3	54	66	LC		
SB02 (GW703943)		556315	6288003	210.6	211.5	45	66	UC/LC		
GW029094 (Billabong 1)	Private	547041	6267503			100	107	Ln	2000	Decommissioned in March 2006. To have been replaced by Billabong 5 in 2008.
GW057974 (Billabong 2)		547180	6268021			96	108	Ln		Decommissioned in March 2004. To have been replaced by Billabong 5 in 2008.
GW701646 (Billabong 3)		545012	6265729		208.0	98	109	Ln		Decommissioned in late 2008. Replaced by Billabong 6.
GW702127 (Billabong 4)		542922	6259675		210.0	108	123	Ln		Commenced October 2005. Replacement for Billabong 1 and Billabong 2.
GW703639 (Billabong 6)		545000	6265720			98	110	Ln		Commenced after 30 June 2008. Replacement for Billabong 3.
GW701267 (Maslin)		552731	6266198				125 ¹	Ln	2000	
GW701454 (QuandiallaTWS)		557158	6240472			98	106	Ln	266	
GW701958 (Muffet)		556272	6270630			88	93	Ln	100	Sand pack from 87 m to 95 m bgl.
GW702013 (Hart)		556515	6278585			102	109	Ln		
GW702262 (MooraMoora)		549449	6293272		212.8	117	125	Ln		Also known as Koreela / McDonald.
GW702286 (Trigalana)		555900	6279959		208.3	102	113	Ln		Also known as the Fuge bore.
Trigalana East		556501	6279959				110 ²	Ln		

1. Completed depth (screen details unavailable).

2. Screen base is an estimate based on structure contour surfaces developed for modelling.

Glossary: m bgl denotes metres below ground level. UC denotes Upper Cowra Formation. LC denotes Lower Cowra Formation. Ln denotes Lachlan Formation. SWL denotes standing water level.

Table 2. Pumping Bores in the Model Domain for which no usage data are available (designated inactive in the model).

Bore Number and/or Name	Owner	Easting (m MGA)	Northing (m MGA)	Ground Elevation (m AHD)	Collar Elevation (m AHD)	Screen Interval (m bgl)		Screened Stratum	Allocation (ML/year)	Comment
						From	To			
GW701579 (Coles)	Private	553767	6269660			107	111	Ln		
GW701681 (Warrakimbo)		552812	6266221			96	111	Ln		Used as an observation bore until 2006.
GW702100 (Hammond)		552407	6285421			107	115	Ln		
GW702230 (Duff)		555812	6287547				66 ¹	UC/LC		Pump tested for ESB.
GW702285 (Mattiske)		553174	6286458			105	114	Ln	1960	
GW703303 (YerraYerra)		555926	6278354			109	114	Ln		Sand pack from 60 to 115 m bgl.
GW703389 (Oakhurst)		548300	6248113				40 ¹	UC/LC		
GW703638 (Billabong 5)		547160	6267785			90	108	Ln		Replacement for Billabong 1 and 2.
Low		550000	6277500						2000	Licence application lodged
Tulloch		544000	6243000						2000	Licence application lodged

1. Completed depth (screen details unavailable).

Glossary: m bgl denotes metres below ground level. UC denotes Upper Cowra Formation. LC denotes Lower Cowra Formation. Ln denotes Lachlan Formation. SWL denotes standing water level.

**Appendix F - Bland Creek Palaeochannel Numerical
Groundwater Flow Model**

Table of contents

1. Structure	1
2. Boundary Conditions	4
2.1. Recharge and Discharge Processes	5
3. Media properties.....	6

Tables

Table 1. Calibrated model media properties.

Figures

Figure 1. Model domain boundary.

Figure 2. Layer parameter zones and boundary conditions.

Bland Creek Palaeochannel Numerical Groundwater Flow Model

1. Structure

The model active area covers about 1,800 km². Figure 1 shows the calculated extents of the Upper Cowra, Lower Cowra, and Lachlan Formations, and the boundary of the modelled area (for the uppermost model layer).

Figure 2 shows the modelled areas for each of the three model layers. The total extents of the Cowra and Lachlan Formations (calculated from borehole data and bedrock outcrop) are also shown in Figure 2 as the darker lines. The model areas do not extend to the extremities of the calculated total extents of the sediments since in these areas the sediments in each formation thin out considerably and practical limits were applied to the model boundaries. The model grid consists of a uniform mesh of 50 m by 50 m cells over the Bland Creek Palaeochannel Borefield (BCPB) area (covering an area of about 36 km²) gradually expanding to a maximum cell size of 1 km by 1 km at the edges of the model area. Cell dimensions increase by a factor of 1.2 between cells to maintain model stability and allow accurate calculation of heads.

The groundwater system is simulated using three layers as follows:

- Layer 1: The Upper Cowra Formation (unconfined). The base of the Upper Cowra is set to 47 m below ground level based on hydraulic conductivity (K) data and downhole gamma logs from bores in the vicinity of the BCPB.
- Layer 2: The Lower Cowra Formation (confined / unconfined).
- Layer 3: The Lachlan Formation (confined / unconfined).

The Upper Cowra Formation has one parameter zone (see Figure 2). The Lower Cowra Formation has three parameter zones (northern, central, and southern) of approximately equal extent, broadly based on geology. The Lachlan Formation has two parameter zones representing:

- High K sands and gravels close to and within the deeper parts of the palaeochannel.
- Lower K, finer-grained sediments that generally occur further away from the deeper parts of the palaeochannel and surround the high K sands and gravels.

K measurements indicate that bedrock K is probably about 1000 times lower, at the same depth, than the high K part of the Lachlan Formation in the deeper parts of the palaeochannel (about 100 m depth). Therefore, bedrock in the Bland Creek Palaeochannel underlying the alluvial sequence has been assumed to be impermeable for the purpose of numerical simulation, and has not been modelled. This is considered reasonable since the rock occurs at burial depths exceeding 100 m (significantly lowering its hydraulic conductivity), and is separated from the alluvial sequence by a low K clay palaeosol of several metres thickness.

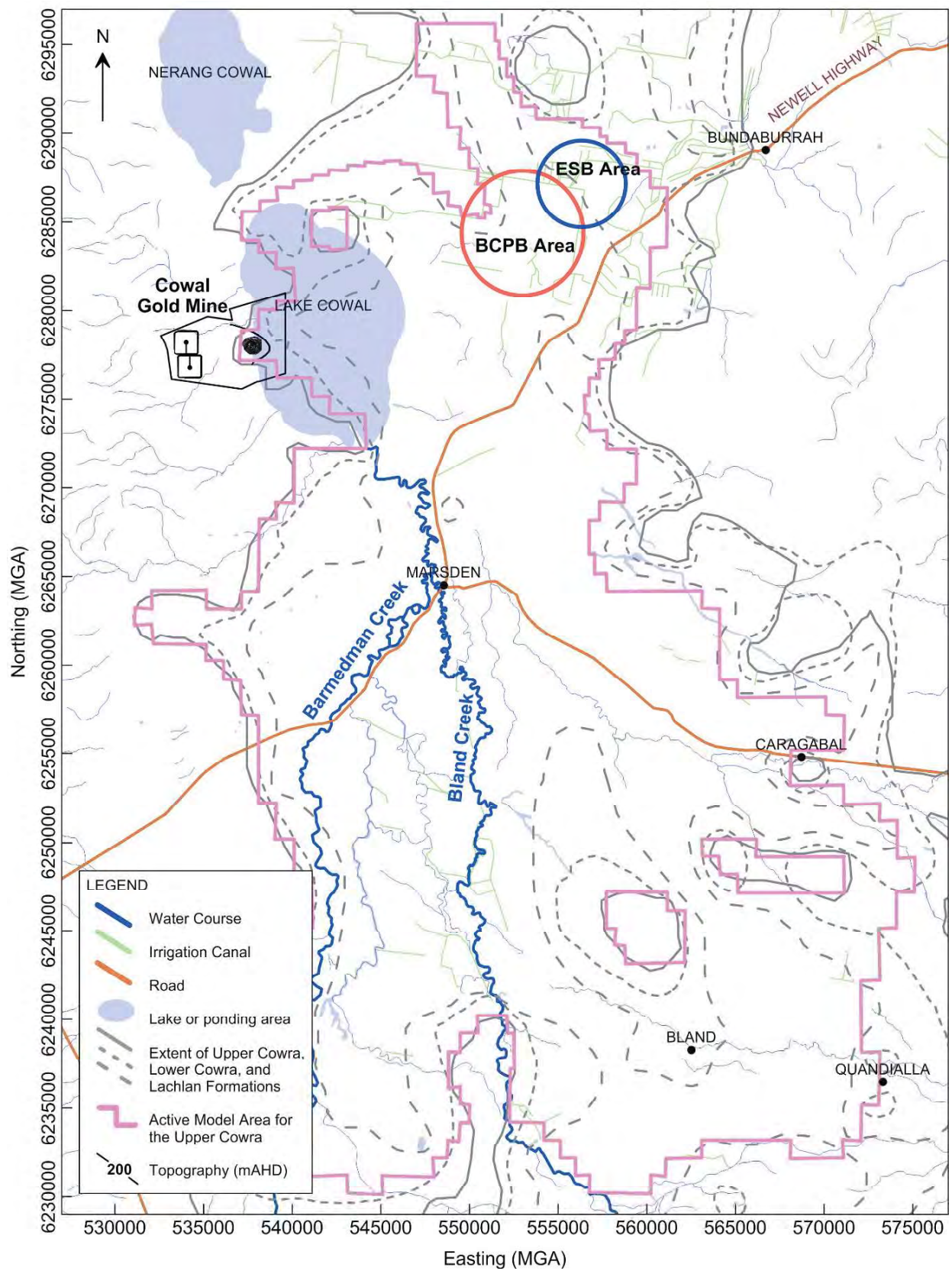
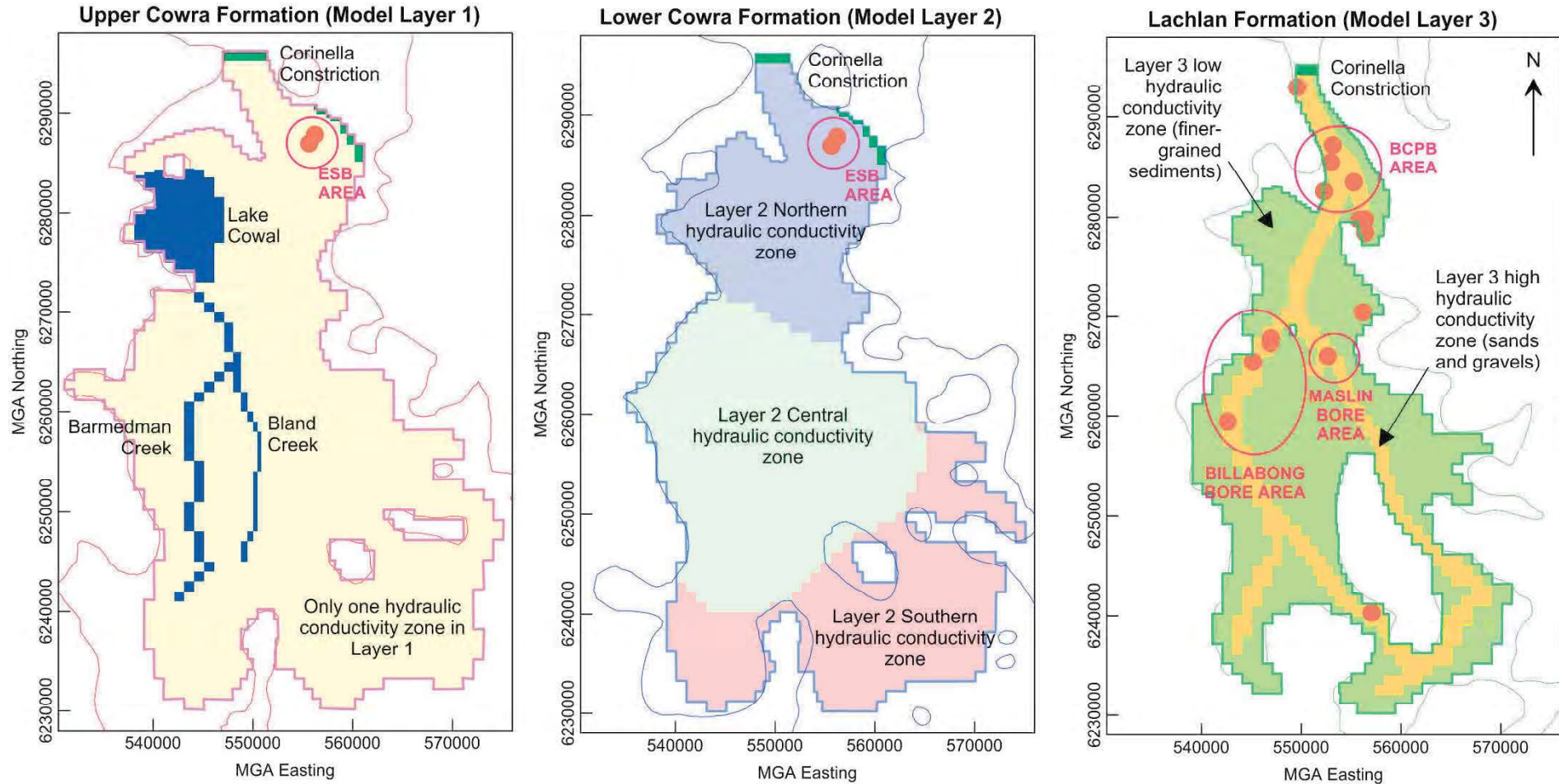

Figure 1. Model domain boundary.



NOTE:

1. Thicker lighter-coloured lines indicate model layer boundaries.
2. Thinner darker-coloured lines indicate interpreted total extents of the formations (to zero thickness).
3. Storativity parameter zones are the same as K parameter zones.

Figure 2. Layer parameter zones and boundary conditions.

2. Boundary conditions

Model boundary conditions are illustrated in Figure 2 and described below.

Rainfall recharge is applied at a uniform percentage of incident rainfall (on a daily, monthly, or yearly basis, depending on stress period size) over the entire extent of the Cowra Formation in the model domain.

The northern boundary of the model was chosen at a point where narrowing of the Bland Creek Palaeochannel is interpreted to occur in the Lachlan Formation at the Corinella Constriction (see Figure 2). Including the area to the north of this point and beyond would have involved the added complexity of treatment of the Lachlan Valley groundwater system and the associated groundwater interactions. To allow groundwater flow across this boundary, a general head condition was applied in all three layers. The general head boundary conditions assigned at this location allow aquifer flow to enter and leave the model at a rate proportional to the difference in head across the boundary.

Parameters for the general head boundaries were initially calculated by assuming that the Lachlan River and Goobang Creek to the north act as ultimate hydraulic controls, and calculating the conductances based on average cell widths, distances to these boundaries from the Corinella Constriction, and estimated layer hydraulic conductivities over this distance. Conductances were then varied slightly during calibration based on the hydrograph for the Koreela bore and government monitoring piezometer GW090093 (see Appendix B of the main report).

Based on a review of stream flow and river stage data from the Government Pinneena database, and field observations, the following water courses have been included in the model using the River package:

- Barmedman and Bland Creeks near Lake Cowal.
- Lake Cowal.

These water courses were selected based on groundwater hydrographs and duration of water flow. Riverbed elevations were assessed from topographic maps, digital elevation data, and stream gauging station survey information. These data were used to assign smoothly-varying riverbed elevations over the model area for the creeks and Lake Cowal. River water level heights were obtained from the Pinneena database. Water levels for Lake Cowal were estimated from data presented in the Cowal Gold Project Environmental Impact Statement (North Limited 1998).

Leakage from Lake Cowal is expected to flow in a northwesterly direction, out of the model active area. To the northwest of Lake Cowal lies Nerang Cowal and a thin cover of surface soil overlying rock. In the model, flow of lake leakage is not possible from the lake to the northwest (because the Upper Cowra Formation is not present there), therefore the calibrated conductance of the lake bed material allows only that flow which reports to the active area of the Upper Cowra Formation in the model.

The CGO Western Saline Borefield (WSB) is located in the mine lease and is included in a separate local groundwater model for the mine lease area, and is not included in the regional model of the current work. The WSB pumps from the Upper Cowra Formation only, at relatively small rates, and is considered unlikely to significantly affect drawdown in the Upper Cowra, Lower Cowra, or Lachlan Formations further east.

The CGO mine pit is included in the separate local groundwater model and is not included in the regional model. The mine pit is located on the western margin of the regional model and intersects alluvial sediments, saprolite (clay), and fractured media. The alluvial sediments are the equivalent of the Upper Cowra Formation. They have been slightly impacted by drainage into the mine pit. The

Lower Cowra and Lachlan Formations are not present at the mine site. The drawdown in the Upper Cowra Formation from pit drainage has been small and localised, and is considered unlikely to significantly affect drawdown in the Upper Cowra, Lower Cowra, or Lachlan Formations further east. Drawdown in the saprolite, saprock, and fresh rock from drainage at the mine pit is not likely to influence groundwater processes in the active model area, apart from the localised effect near the pit of inducing vertical drainage from the Upper Cowra Formation (in addition to lateral drainage towards the pit face).

18 pumping bores are active in calibration, verification, or predictive model simulations. These comprise six Evolution bores (4 at the BCPB and 2 at the ESB) and 12 private bores. Appendix E of the main report lists these bores and their details. Low-extraction basic rights bores (used for stock and domestic purposes) are not included.

2.1. Recharge and discharge processes

Model recharge processes are:

- Rainfall recharge.
- Leakage from rivers (Bland Creek and Lake Cowal).
- Flow into the model from the Corinella Constriction in all layers.

Model discharge processes are:

- Groundwater extraction from the Upper Cowra, Lower Cowra, and Lachlan Formations.
- Leakage to rivers (Bland Creek and Lake Cowal).
- Flow out of the model to the Corinella Constriction in all layers.

Evaporation is not modelled because the average depth of the water table in the Upper Cowra Formation is around 5 m over the majority of the model domain, and below the extinction depth typical for the land use, surface lithology, and climate of the area.

Intermittent recharge from flooding from remnant ponds outside the water course channels is not modelled in calibration simulations since no flooding was known to have occurred in the area during the model calibration period. However, the calibrated riverbed conductances and rainfall recharge would incorporate the effect of this process where it may have occurred but was not explicitly identified in observations.

3. Media properties

Calibrated model media properties are listed in Table 1.

Initial estimates for riverbed conductance were based on consideration of values used for river systems in the Lower Namoi Valley groundwater flow model (Merrick 1989). The Lower Namoi Valley and Bland Creek Palaeochannel display many similar characteristics such as climate, subsurface media types, and river types.

Automated parameter estimation conducted as part of the 2006 modelling process indicated that the calibrated values for various parameters were considered defensible and appropriate based on site-specific observations, published studies, and model formulation. A finding of the estimation study was that in the more southerly parts of the model domain the vertical leakance in the Cowra Formation was likely to be lower than the calibrated value of the 2006 model. It was considered that, based on available data, the vertical leakance between the Cowra and Lachlan Formations was likely to decrease in a southerly direction. This finding was taken into account by dividing the Lower Cowra Formation into three zones (northern, central, and southern) of approximately equal extent, broadly based on geology, so that vertical leakance could be varied between zones.

Table 1. Calibrated model media properties.

Parameter	Model Zone					
	Upper Cowra	Lower Cowra (North)	Lower Cowra (Central)	Lower Cowra (South)	Lachlan (Low Conductivity)	Lachlan (High Conductivity)
Lateral Hydraulic Conductivity (m/day)	1	2	1	1	3	28
Average Thickness over Model Area (m)	35	34	34	34	30	30
Average Transmissivity over Model Area (m ² /day)	35	68	34	34	90	840
Vertical Hydraulic Conductivity (m/day)	6 x10 ⁻⁵	1 x10 ⁻⁵	6 x10 ⁻⁶	1x10 ⁻⁵	3	28
Specific Storage (m ⁻¹)	N/A	1.5x10 ⁻⁵	1.5x10 ⁻⁵	1.5x10 ⁻⁵	1.5x10 ⁻⁵	1.5x10 ⁻⁵
Specific Yield	0.04	N/A	N/A	N/A	N/A	N/A
General Head Boundaries						
External Head (mAHD)	198	196	N/A	N/A	N/A	196
Conductance (m ² /day)	1	1	N/A	N/A	N/A	25
River Bed Conductance (m ² /day):						
Bland and Barmedman Creeks	10	N/A	N/A	N/A	N/A	N/A
Lake Cowal	5	N/A	N/A	N/A	N/A	N/A
Rainfall Recharge (% of average annual rainfall)	1.0	N/A	N/A	N/A	N/A	N/A

Assuming an average river channel width of 20 m (including overbank ponds), an average river reach of 1200 m in each cell, and 0.2 m of barrier material in the river bottom, the calibrated riverbed conductance for Bland and Barmedman Creeks is equivalent to a vertical hydraulic conductivity for the river bed barrier material of 9 x 10⁻⁵ m/day. For Lake Cowal leakage occurs over the entire area of each cell so the riverbed conductance is equivalent to a vertical hydraulic conductivity in the lake bed material of 1 x 10⁻⁶ m/day. This compares favourably with results from laboratory analysis of lakebed sediments indicating an average vertical hydraulic conductivity of 5.0 x 10⁻⁷ m/day (Hawkes

1998), allowing for upscaling from a laboratory sample scale to a regional scale. Hydraulic test results in Hawkes (1998) also indicate an average lateral hydraulic conductivity for the lake bed material of 5.5×10^{-5} m/day for one location on the lake.

Rainfall recharge is calibrated to 1% of annual rainfall and compares favourably with other estimates for the area (between 0.3% and 2%). It is an overall average for the model area, mostly comprising recharge from rainfall and irrigation, but also likely to contain a small component representing seepage from shallow, higher conductivity rock on the fringes of the alluvial sediments. It is also likely that the calibrated value includes the effects of intermittent ponding associated with water courses.

The calibrated specific storage ($1.5 \times 10^{-5} \text{ m}^{-1}$) compares favourably with pump test results (average of around $9 \times 10^{-6} \text{ m}^{-1}$).

Appendix G - Verification Hydrographs

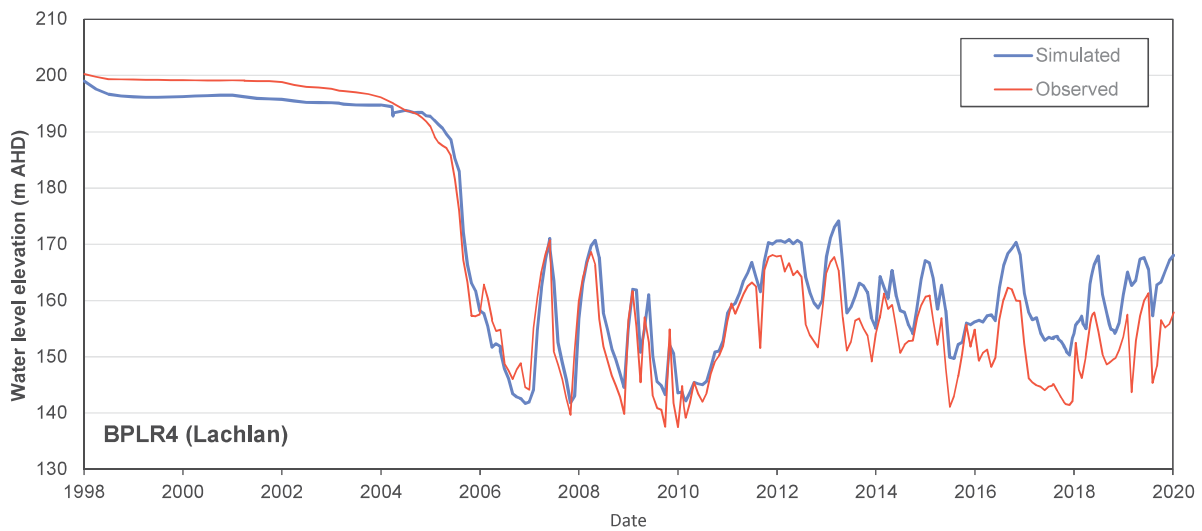
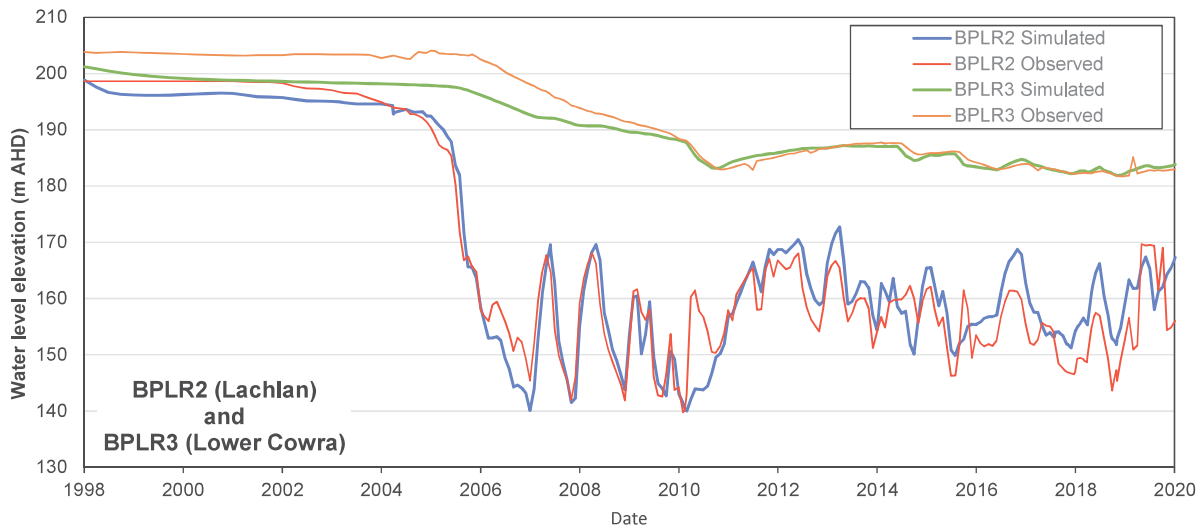
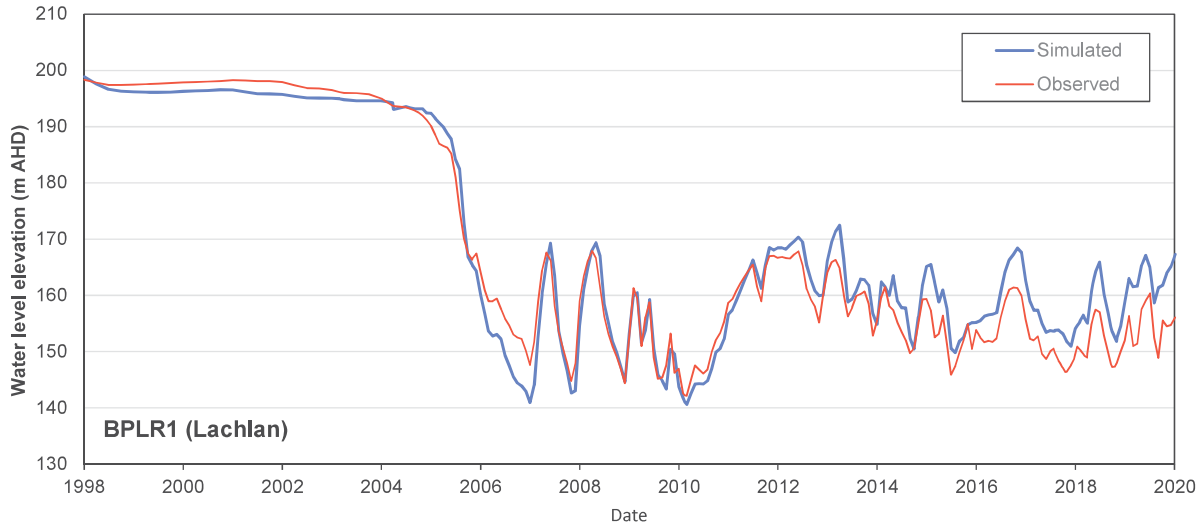

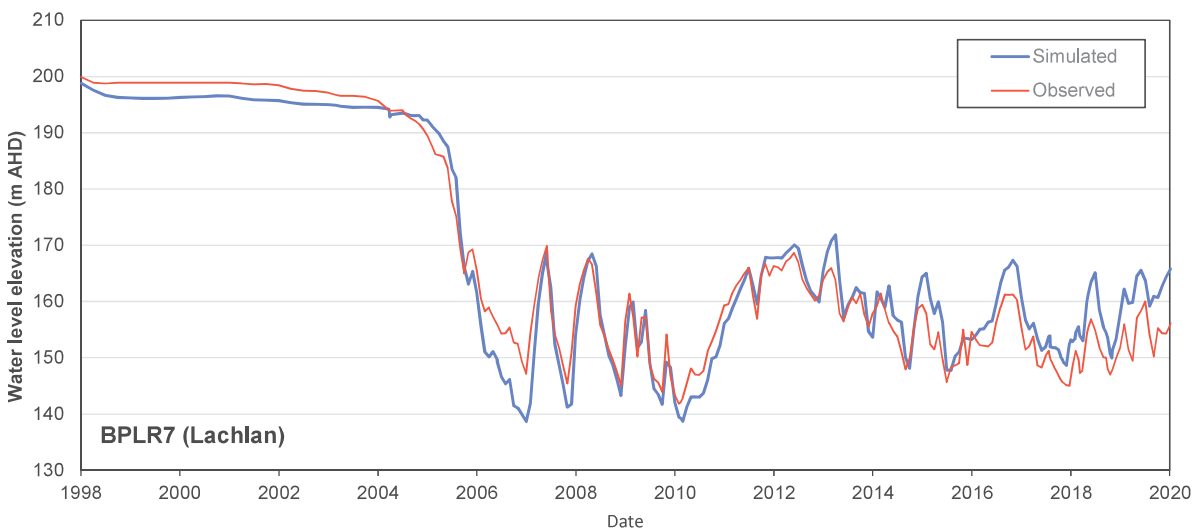
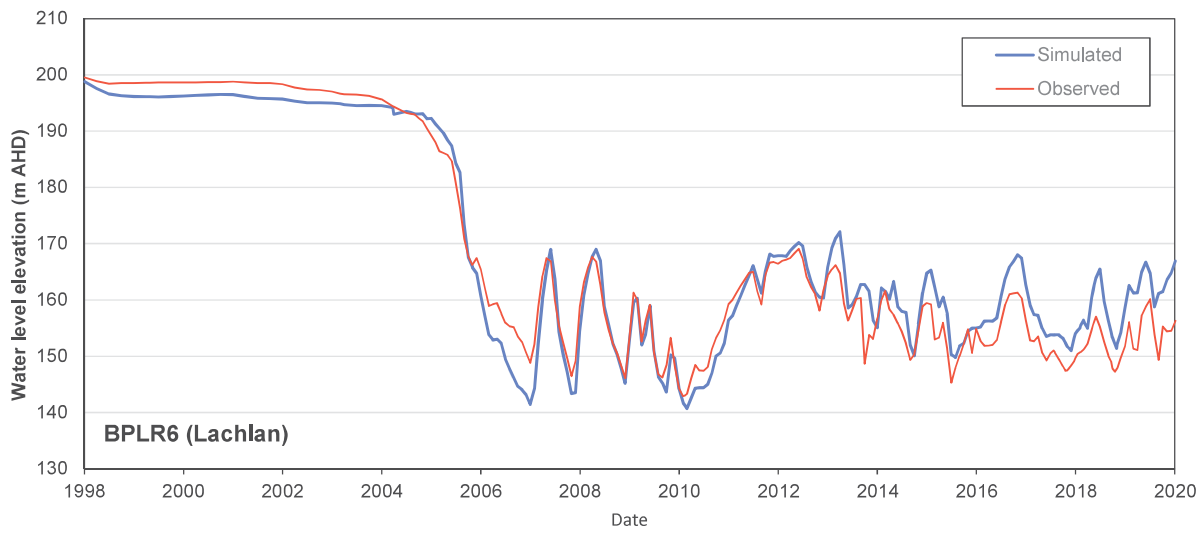
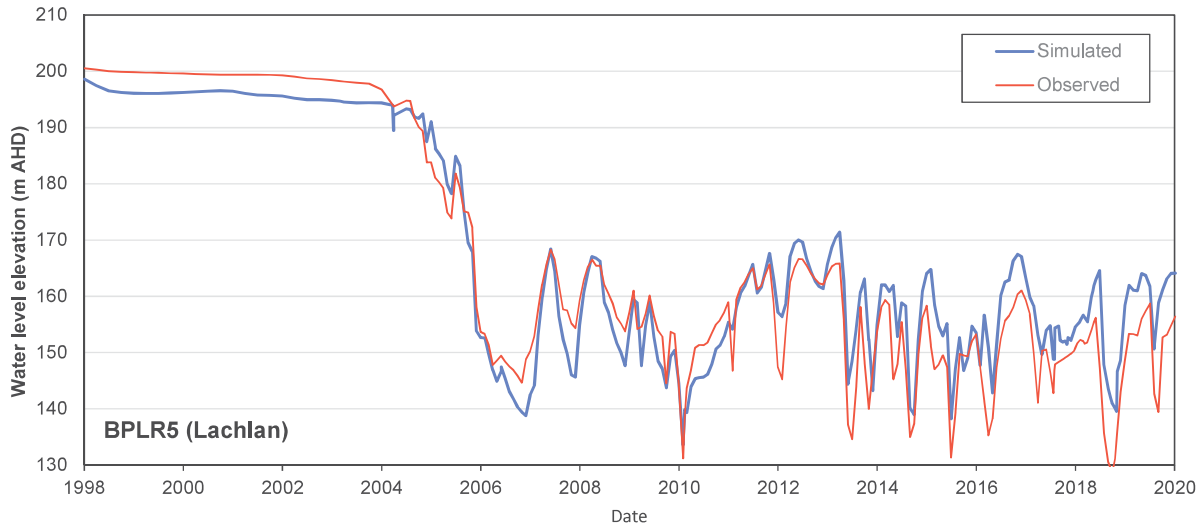

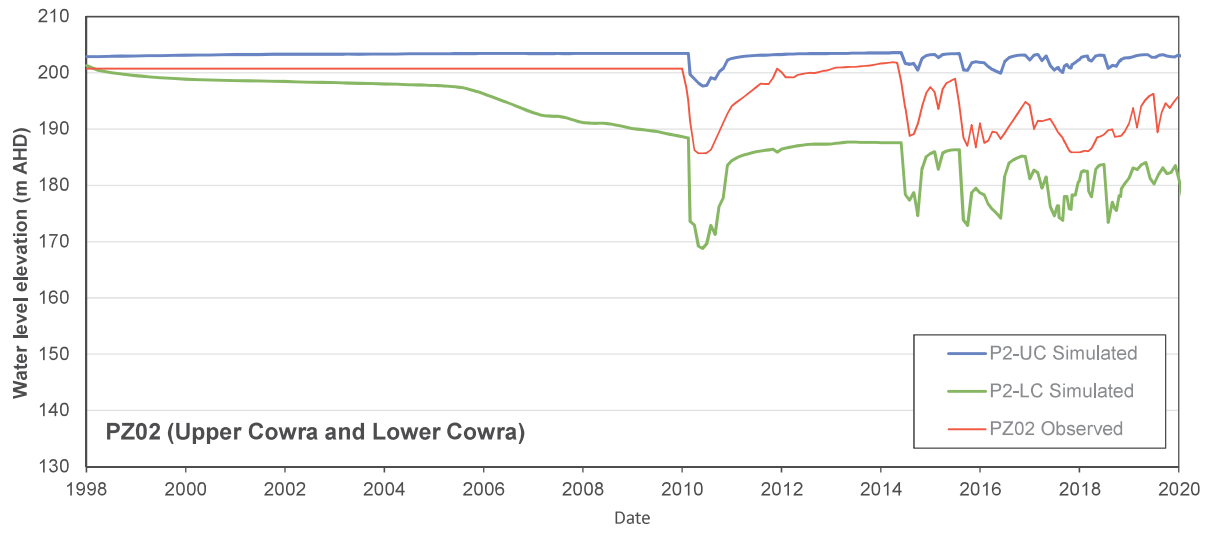

**Appendix H - Drawdown in the Lower Cowra and
Lachlan Formations at the end of BCPB and ESB
Operation (30 June 2040)**

Drawdown in the Lower Cowra Formation at the end of BCPB and ESB Pumping (30 June 2040)

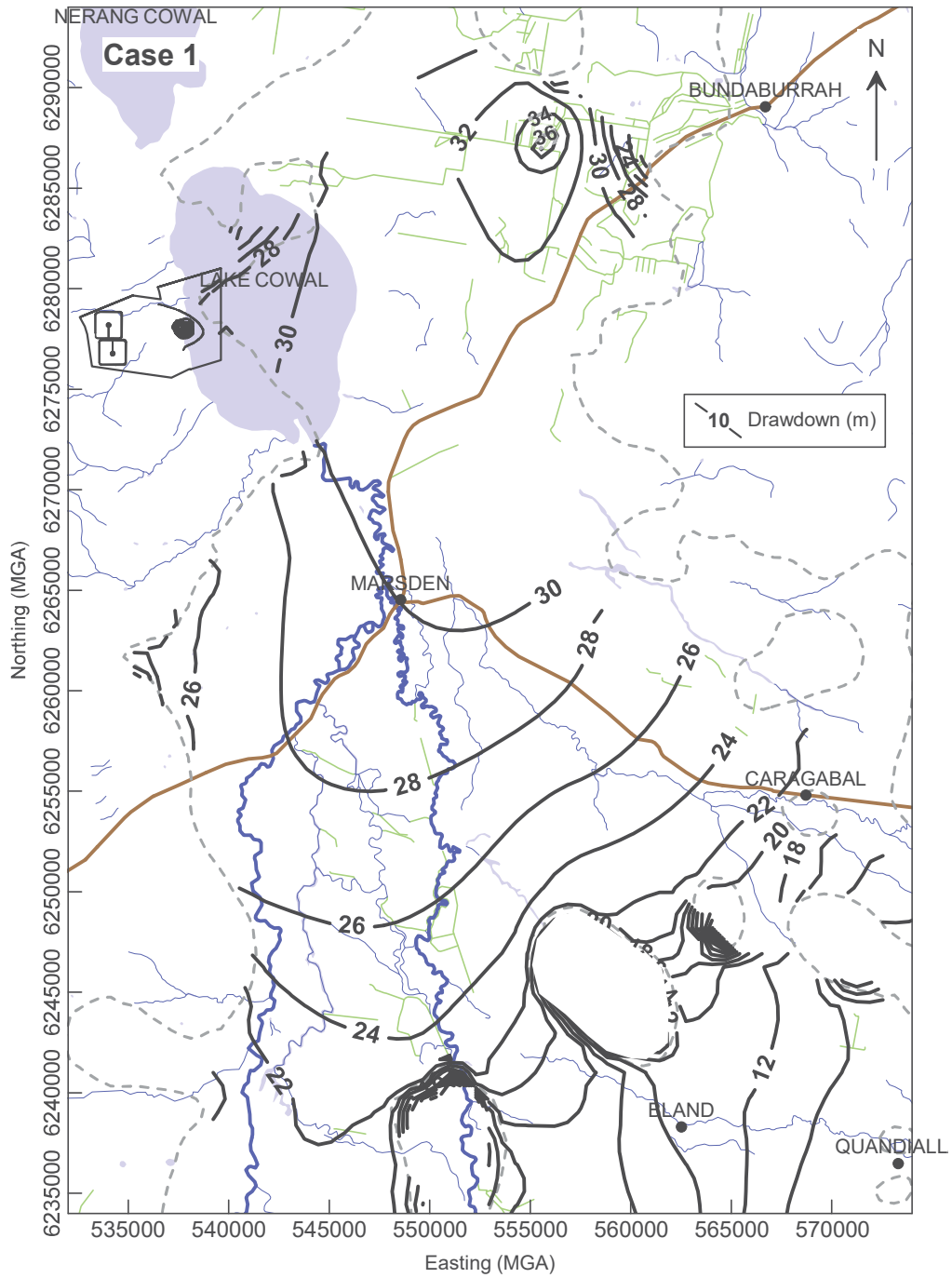

Drawdown in the Lachlan Formation at the end of BCPB and ESB Pumping (30 June 2040)

